



MADE IN ITALY

# TeraPlast™

2 0 1 8

Linea **Re**

Intro **Self Watering**

Linea **Groove**

Linea **Elements**

Linea **Clear**

Linea **Pastel**

Linea **Colour**

Linea **Basic**

**Display**

Balconiere

**T-basket**

Linea **Flortec**

Linea **Essential**

**Self Watering**

Linea **Classic**

Linea **City**

Linea **Luce**

**Accessori**

indice **PRODOTTI**  
Index  
Index  
Verzeichnis



**Linea Re**

- 26 Re-Pots Hoop  
30 Re-Pebbles

**Intro Self Watering**

- 34 Intro Self Watering

**Linea Groove**

- 40 Arena  
46 Indy  
50 Pixel  
56 Ring  
58 Urban

**Linea Elements**

- 64 Stem  
66 Stalk  
70 Stem luce/Stalk luce  
72 Air  
74 Hydral  
82 Still  
84 Aqua  
86 Basilio  
90 Kit balcone Hydral

**Linea Clear**

- 94 Orchidea  
95 Plato Quadro  
96 Porto/Plato  
97 Madeira  
98 Coimbra  
99 Algarve

**Linea Pastel**

- 102 Madeira pastel  
104 Estoril pastel  
106 Santiago pastel

**Linea Colour**

- 110 Trio  
112 Sunrise

- 114 Orchidea  
116 Plato Quadro  
118 Plato  
120 Santiago  
122 Estoril water reserve  
124 Porto  
128 Algarve  
132 Madeira Luxy  
134 Madeira  
136 Coimbra

**Linea Basic**

- 140 Cilindro colour  
143 Cilindro classic  
144 Campana colour  
145 Campana classic  
146 Ciotola coste/Vaso coste  
147 Ciotola con sottovaso  
148 Sottovaso colour  
149 Sottovaso classic  
150 Quadro colour  
151 Quadro classic  
152 Cassettone colour  
153 Cassettone classic  
154 Sottovaso Quadro color/Sottovaso Quadro  
155 Sottocassettone colour/Sottocassettone  
156 Cassetta mare colour  
159 Cassetta mare classic  
160 Cassetta Cortina colour  
161 Cassetta Cortina classic  
162 Cassetta Tirol  
163 Cassetta Portofino colour  
164 Cassetta Portofino classic  
166 Cassetta coste  
167 kit balcone Coste/supporto Coste/supporto Mare  
168 Sottocassetta colour  
169 Sottocassetta classic

**Display**

- 170 Espositore Hydral  
171 Espositore cilindri e sottovasi  
172 Espositore cassette e sottocassette  
173 Espositore cilindri/Espositore sottovasi  
174 Marketingsupport

**Balconiere**

- 180 display kit balcone Mare 1 pz  
181 display kit balcone Mare 2 pz

**T-basket**

- 184 T-Basket  
186 T-Basket big

**Linea Flortec**

- 190 vaso Norma  
192 vaso Container/vaso Crisa  
193 vaso Basso/Gabbia verde

**Linea Essential**

- 196 Divio indoor/Corner indoor  
200 Schio cassa  
201 Schio sottocassa  
202 Schio cubo  
203 Schio sottocubo  
204 Schio cubo basso  
205 Schio cubo alto  
208 Avila  
210 Ribeira  
212 Zamora  
214 Leon  
216 Standard One  
218 quadro Veneto  
219 cassa Veneto  
220 jardinera Veneto  
221 tondo Veneto  
222 Schio cassa alta  
223 Schio cono  
224 Pasubio quadro  
225 Pasubio cassa  
226 Pasubio alto  
228 Schio ciotola  
229 Valentino/Bassano

**Self Watering**

- 233 Divio self watering  
234 Schio cubo self watering  
235 Schio cassa self watering

**Linea Classic**

- 238 Flora  
239 cilindro Vicenza  
240 cassetta liscia  
241 quadro liscio  
242 Africa/Tulipano  
243 vaso festonato/vaso doppio bordo  
244 campana Chiampo/cassetta Leonardo  
245 cassetta millerighe/quadro millerighe  
246 ciotola Castello/conca Classica  
247 vaso Muro righe/vaso Muro liscio  
248 sottovaso Muro/sottovaso Tondo  
249 sottovaso Quadro/Sottocassetta

**Linea City**

- 252 New York  
253 Venezia  
254 Roma  
255 A-Malo

**Linea Luce**

- 258 Standard one outdoor  
259 Spritz  
260 Africa outdoor  
261 Tulipano outdoor  
262 Valentino outdoor  
263 Pasubio alto outdoor  
264 Bassano outdoor  
265 Schio cassa alta outdoor  
266 Schio cubo alto outdoor  
267 Schio cono outdoor  
268 A-malo luce outdoor

**Accessori**

- 270 Mover  
272 Fix ground round/Fix ground square  
273 Fix Wall

# Legenda

## Legenda

### Légende

### Legende



**Superficie lucida**  
Glossy surface  
Surface brillante  
Glänzende Oberfläche

I vasi con la superficie lucida sono allegri e colorati. Si adattano facilmente al contesto creando un ambiente fresco e vivace.

Pots with glossy surface are jolly and bright. They be easily fit to the context, making the background fresh and vivid.

Les vases avec la surface brillante sont gais et colorés. Ils s'adaptent au contexte aisément en créant un milieu frais et vif.

Pflanzgefäße mit glänzender Oberfläche sind heiter und farbig. Sie richten sich nach dem Kontext und machen die Atmosphäre frisch und lebhaft.



**Superficie opaca**  
Matt finished  
Surface opaque  
Matt-Oberfläche

I vasi con la superficie opaca sono eleganti e raffinati. Si prestano ad arredare i tuoi spazi con gusto e armonia.

Pots with matt surface are elegant and refined. They are fit to furnish your space with taste and harmony.

Les vases avec la surface opaque sont élégants et raffinés. Ils se prêtent à meubler vos espaces avec goût et harmonie.

Pflanzgefäße mit matter Oberfläche sind elegant und verfeinert. Ideal um Ihren Raum durch Geschmack und Harmonie auszustatten.

 sottovaso / saucer  
soucoupes / untersetzer

 sacchetto / bag  
sachets /beutel

 sfuso / loose pieces  
en vrac / lose Stk

 display pallet

 pallet di scatole  
pallet of carton boxes

 scatola / box  
carton / karton

 pallet

 fix ground

 fix wall

 supporto Cassetta Coste  
Iron support for Cassetta Coste  
Support pour jardinière Coste  
Träger für die Cassetta Coste

 supporto Cassetta Mare  
Iron support for Cassetta Mare  
Support pour Cassetta Mare  
Träger für die Cassetta Mare

 Self Watering  
SELF WATERING

La riserva d'acqua permette di alimentare le vostre piante senza bisogno di irrigarle spesso.  
Water system allows to feed plants without needing to irrigate it often.  
La réserve d'eau permet d'alimenter vos plantes sans besoin de leur irriguer souvent.  
Das Wasser-Reservoir ermöglicht es, die Pflanzen zu versorgen, ohne oft zu begießen.

 Evita l'annidamento di zanzare e altri insetti.  
It stops mosquitoes and other insects from laying eggs.  
Évite la nidation des moustiques et autres insectes.  
Das Einnisten von Mücken und anderen Insekten wird verhindert.

 Leggerissimo  
Very light  
Très léger  
Sehr Leicht

 Inalterabile nel colore  
Colourfast dyes  
Inalterabilité des couleurs  
Farbbeständig  
U.V. RESISTANT

 Resistente al caldo e al freddo  
Warm and cold resistant  
Résistant à la chaleur et au froid  
Wetterfest  
-30 +60

 Sottovaso incluso  
Saucer included  
Soucoupe intégrée  
Integrierter unterstzer

 Resistente agli urti  
Shock resistant  
Résistant aux chocs  
Stoß und Bruchfest

 Ecologico: atossico e riciclabile  
Ecological: non-toxic and recyclable  
Ecologique: recyclable et not toxique  
Umweltfreundlich: nicht toxisch und recyclingfähig  
RECYCLABLE

Siamo molto orgogliosi del nostro impianto fotovoltaico da 1,17 MW, posizionato sui tetti dei reparti produttivi e del magazzino, con il quale produciamo energia pulita per poter produrre i nostri vasi. Questa scelta, insieme all'utilizzo di materie prime riciclate di alta qualità e a politiche atte ad evitare sprechi in fase di imballaggio, rende Teraplast uno dei produttori di vasi più sostenibile.

We are very proud of our photovoltaic installation of 1,17 MW, placed on the roof of our production and warehouse, wherewith we produce clean energy to produce our pots. This choice, together with the use of high quality recycled raw material and strict policies to avoid wastes in the packaging process, emphasizes Teraplast as one of the most environmental friendly company.

Nous sommes très fiers de notre installation photovoltaïque de 1,17 MW, positionné sur les toits des rayons productifs et du magasin avec laquelle nous produisons énergie propre pour pouvoir produire nos vases. Avec le choix d'utiliser des matières premières recyclées de haute qualité en contribuant à la politique d'antigaspiages en phase d'emballage, Teraplast devient un des producteurs de vases les plus respectables.

Wir sind sehr stolz auf unsere Photovoltaikanlage mit 1,17 MW, auf dem Werk- und Lagerdach, womit wir saubere Energie erzeugen, um unsere Töpfe herzustellen. Diese Entscheidung, zusammen mit der Verwendung von recycelt hochwertigen Rohstoffe und ohne Verschwendungen in der Verpackungsphase, macht TeraPlast einer der am nachhaltigsten Hersteller von Pflanzgefäße.

 Con lampadina  
Illuminated  
Lumineux  
Mit licht

 Facilente lavabile senza detersivi  
Easy to wash without detergents  
Très facile à entretenir  
Einfach ohne Reinigungsmittel waschbar

 Impilabile  
Stackable  
Impilables  
Stapelbar

Per agevolare il trasporto e la vendita a scaffale molti dei nostri vasi sono impilabili.

A wide range of our pots are stockable in order to ensure easy transportation and friendly merchandising.

Pour faciliter le transport et la vente en étagères beaucoup de nos vases sont impilables.

Unsere Pflanzgefäße sind stapelbar, um den Transport und den Verkauf auf Regale zu erleichtern.

 Foro predisposto  
Can be drilled to drainage  
Trous de drainage prévus  
Loch Vorsatz

I vasi con il foro predisposto possono essere facilmente forabili per permettere il drenaggio dell'acqua. Una volta effettuata questa operazione si consiglia l'abbinamento con il sottovaso adeguato.

Pre drilled pots can be easily drilled to allow the drain of the water. Once done this operation we recommend to combine them with the suitable saucer.

Les vases qui ont le trou prépercé peuvent favoriser le drainage de l'eau. Une fois cette opération effectuée veuillez demander conseil au distributeur afin de trouvé le dessous de pot correspondant.

Pflanzgefäße mit vorgesehenem Loch sind einfach durchzulöchern für den Wasserdränage. Nach dem Durchlöchern ist die Benutzung des anpassenden Untersetzers zu empfehlen.



linea  
**BASIC**



Cilindro



Campana



Ciotola Coste



Vaso Coste



Ciotola  
Con Sottovaso



Sottovaso



Quadro



Cassettone



Sottovaso  
Quadro



Sottocassettone



Cassetta Mare



Cassetta Cortina



Cassetta Tirol



Cassetta  
Portofino



Cassetta Coste



Sottocassetta



**407**  
salvia/sage  
sauage/salbei



**409**  
malva/mauve  
mauve/malve



**415**  
terra di Siena/terra di siena  
terra di siena/terra di siena



**414**  
fog grey/fog grey  
brouillard gris/Nebel grau



**Sottovaso**  
pagina 148

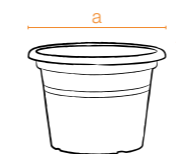

codice senza colore code without colour	Cm	dimensioni dimensions	litri liters	Confezione minima Minimum package	m <sup>3</sup>	pezzi pallet pcs pallet	m <sup>3</sup>
01 001 020	20	a20 b14,2	2,5	18	20 20x20x36h	0,014	1440 80x120x120h 1,15
01 001 025	25	a25 b17,7	4,8	22	10 25x25x30h	0,019	720 80x120x110h 1,06
01 001 030	30	a30 b21,2	8,5	26	10 30x30x34h	0,031	400 80x120x110h 1,06
01 001 035	35	a35 b24,6	13	30	10 35x35x39h	0,048	300 80x120x120h 1,15
01 001 040	40	a40 b27,2	19	35	10 40x40x42h	0,067	300 80x120x120h 1,15
01 001 045	45	a45 b31,4	29	40	10 45x45x46h	0,093	330 80x120x230h 2,21
01 001 050	50	a50 b34,9	41	45	5 50x50x42h	0,105	380 100x120x220h 2,64



Superficie opaca  
Matt finished  
Surface opaque  
Matt-Oberfläche



**Cilindro**  
colour



## Cilindro colour

Superficie opaca  
Matt finished  
Surface opaque  
Matt-Oberfläche



**022**

bianco/white  
blanc/weiß



**403**

corda/cord  
corde/seil



**406**

bruno/brown  
brun/braun



**408**

cacao/cocoa  
cacao/kakao



**018**

ciclamino/cyclamen  
cyclamen/zyklamfarbe



**019**

lilla/lilac  
lilas/lila



**404**

cedro/cedar  
cèdre/zeder



**Sottovaso**  
pagina 148

codice senza colore code without colour	Cm	dimensioni dimensions	litri liters	Confezione minima Minimum package	m <sup>3</sup>	pezzi pallet pcs pallet	m <sup>3</sup>
01 001 015	15	a15 b10,8	1,2	14	0,007	2880	1,06
01 001 018	18	a18 b12,8	2	16	0,010	2240	1,06
01 001 020	20	a20 b14,2	2,5	18	0,014	1440	1,15
01 001 025	25	a25 b17,7	4,8	22	0,019	720	1,06
01 001 030	30	a30 b21,2	8,5	26	0,031	400	1,06
01 001 035	35	a35 b24,6	13	30	0,048	300	1,15
01 001 040	40	a40 b27,2	19	35	0,067	300	1,15
01 001 045	45	a45 b31,4	29	40	0,093	330	2,21
01 001 050	50	a50 b34,9	41	45	0,105	380	2,64
01 001 060	60	a60 b41,8	69	52	0,180	170	2,16
01 001 070	70	a70 b49	120	65	0,328	40	1,45

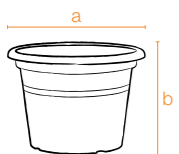

Superficie opaca  
Matt finished  
Surface opaque  
Matt-Oberfläche



**001**

terracotta/terracotta colour  
couleur terre/farbe terrakotta



**005**

antracite/anthracite  
anthracite/anthrazitgrau



**Sottovaso**  
pagina 148

codice senza colore code without colour	Cm	dimensioni dimensions	litri liters	Confezione minima Minimum package	m <sup>3</sup>	pezzi pallet pcs pallet	m <sup>3</sup>
01 001 015	15	a15 b10,8	1,2	14	0,007	2880	1,06
01 001 018	18	a18 b12,8	2	16	0,010	2240	1,06
01 001 020	20	a20 b14,2	2,5	18	0,014	1440	1,15
01 001 025	25	a25 b17,7	4,8	22	0,019	720	1,06
01 001 030	30	a30 b21,2	8,5	26	0,031	400	1,06
01 001 035	35	a35 b24,6	13	30	0,048	300	1,15
01 001 040	40	a40 b27,2	19	35	0,067	300	1,15
01 001 045	45	a45 b31,4	29	40	0,093	330	2,21
01 001 050	50	a50 b34,9	41	45	0,105	380	2,64
01 001 060	60	a60 b41,8	69	52	0,180	170	2,16
01 001 070	70	a70 b49	120	65	0,328	40	1,45
01 001 090	90	a90 b64	240	80	0,664	35	2,83

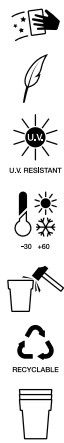
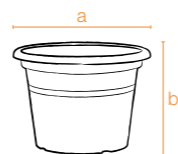



Superficie opaca  
Matt finished  
Surface opaque  
Matt-Oberfläche



## Campana colour



**022**  
bianco/white  
blanc/weiß



**018**  
ciclamino/cyclamen  
cyclamen/zyklamfarbe



**019**  
lilla/lilac  
lilas/lila



**404**  
cedro/cedar  
cèdre/zeder



**Sottovaso**  
pagina 148

codice senza colore code without colour	Cm	dimensioni dimensions	litri liters		Confezione minima Minimum package	m³	pezzi pallet pcs pallet	m³
01 002 020	20	a20 b13,8	2,2	18	20 20x20x40h	0,01	1080 80x120x113h	1,08
01 002 025	25	a25 b17,2	4,4	22	10 25x25x33h	0,02	600 80x120x115h	1,10



Superficie opaca  
Matt finished  
Surface opaque  
Matt-Oberfläche



## Campana classic



**001**  
terracotta/terracotta colour  
couleur terre/farbe terrakotta



**005**  
antracite/anthracite  
anthracite/anthrazitgrau



**Sottovaso**  
pagina 148

codice senza colore code without colour	Cm	dimensioni dimensions	litri liters		Confezione minima Minimum package	m³	pezzi pallet pcs pallet	m³
01 002 020	20	a20 b13,8	2,2	18	20 20x20x40h	0,01	1080 80x120x113h	1,08
01 002 025	25	a25 b17,2	4,4	22	10 25x25x33h	0,02	600 80x120x115h	1,10
01 002 030	30	a30 b20,7	7,5	26	10 30x30x37h	0,03	400 80x120x120h	1,15
01 002 035	35	a35 b24,1	12	30	10 35x35x41h	0,05	240 80x120x113h	1,08
01 002 040	40	a40 b26,8	16,5	35	10 40x40x45h	0,07	240 80x120x120h	1,15
01 002 045	45	a45 b31,1	25,5	40	10 45x45x51h	0,10	320 100x120x213h	2,56
01 002 050	50	a50 b34,6	35	45	5 50x50x45h	0,11	320 100x120x225h	2,70
01 002 060	60	a60 b41,4	60	52	5 60x60x53h	0,19	260 120x120x215h	2,58

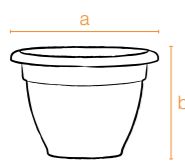



# Ciotola coste

Superficie opaca / Matt finished  
Surface opaque / Matt-Oberfläche



**001**  
terracotta/terracotta colour  
couleur terre/farbe terrakotta



**005**  
antracite/anthracite  
anthracite/anthrazitgrau

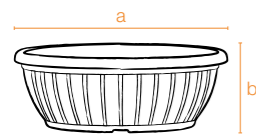

codice senza colore code without colour	Cm	dimensioni dimensions	litri liters		Confezione minima Minimum package	m <sup>3</sup>	pezzi pallet pcs pallet	m <sup>3</sup>
01 010 020	20	a20 b8	1,6	20	20x20x35h	0,01	1200	80x120x110h 1,06
01 010 025	25	a25 b9	3	26	25x25x25h	0,01	600	80x120x105h 1,01
01 010 030	30	a30 b11	5,2	30	30x30x29h	0,02	360	80x120x103h 0,99
01 010 035	35	a35 b12,5	8	35	35x35x31h	0,03	280	80x120x114h 1,09
01 010 040	40	a40 b14	12	40	40x40x38h	0,06	180	80x120x107h 1,03
01 010 050	50	a50 b18	24	52	50x50x43h	0,10	280	100x120x220h 2,64

# Ciotola con sottovaso

Superficie opaca / Matt finished  
Surface opaque / Matt-Oberfläche



**001**  
terracotta/terracotta colour  
couleur terre/farbe terrakotta



**005**  
antracite/anthracite  
anthracite/anthrazitgrau

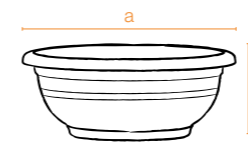

codice senza colore code without colour	Cm	dimensioni dimensions	litri liters		Confezione minima Minimum package	m <sup>3</sup>	pezzi pallet pcs pallet	m <sup>3</sup>
01 009 030	30	a30 b11,5	5	incl	10 30x30x25h	0,02	400	80x120x105h 1,01
01 009 040	40	a40 b15,5	11,5	incl	10 40x40x32h	0,05	240	80x120x103h 0,99
01 009 050	50	a50 b18		incl	10 50x50x38h	0,09	360	100x120x212h 2,54

# Vaso coste

Superficie opaca / Matt finished  
Surface opaque / Matt-Oberfläche



**001**  
terracotta/terracotta colour  
couleur terre/farbe terrakotta



**005**  
antracite/anthracite  
anthracite/anthrazitgrau

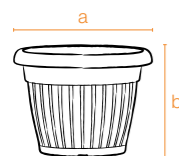

codice senza colore code without colour	Cm	dimensioni dimensions	litri liters		Confezione minima Minimum package	m <sup>3</sup>	pezzi pallet pcs pallet	m <sup>3</sup>
01 003 020	20	a20 b14,8	2,5	18	20x20x46h	0,01	900	80x120x110h 1,06
01 003 025	25	a25 b18,4	4,9	22	25x25x52h	0,03	240	80x120x105h 1,01
01 003 030	30	a30 b21,8	8,4	26	30x30x56h	0,05	160	80x120x105h 1,01
01 003 035	35	a35 b25,7	13	30	35x35x59h	0,07	120	80x120x110h 1,06
01 003 040	40	a40 b29,4	20	35	40x40x61h	0,09	120	80x120x115h 1,10
01 003 045	45	a45 b33,1	29	40	45x45x64h	0,13	150	80x120x215h 2,06
01 003 050	50	a50 b36,8	40	45	50x50x51h	0,12	200	100x120x227h 2,72
01 003 060	60	a60 b44,1	70	52	60x60x58h	0,20	100	80x120x210h 2,11

misura 30 cm disponibile  
anche con gancio  
hook available for size 30 cm  
Haken für 30er Größe  
verfügbar  
crochet disponible pour  
mesure 30 cm

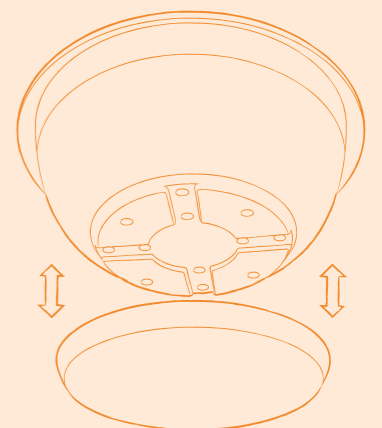

Il sottovaso è incluso e viene fissato ad incastro.

The saucer is included and is fitted into.  
La soucoupe est inclus et est emboîtée dans.

Der Untersetzer ist eingeschlossen und mit Clip-Funktion zusammengesteckt.

# Sottovaso colour

Superficie opaca / Matt finished  
Surface opaque / Matt-Oberfläche



**022**  
bianco/white  
blanc/weiß



**403**  
corda/cord  
corde/seil



**406**  
bruno/brown  
brun/braun



**408**  
cacao/cocoa  
cacao/kakao



**018**  
ciclamino/cyclamen  
cyclamen/zyklamfarbe



**019**  
lilla/lilac  
lilas/lila



**404**  
cedro/cedar  
cèdre/zeder



**407**  
salvia/sage  
sauge/salbei



**409**  
malva/mauve  
mauve/malve



**415**  
terra di Siena/terra di siena  
terra di siena/terra di siena



**414**  
fog grey/fog grey  
brouillard gris/Nebel grau

codice senza colore code without colour	Cm	dimensioni dimensions	Confezione minima Minimum package	m <sup>3</sup>	pezzi pallet pcs pallet	m <sup>3</sup>
01 011 014	14	a14 b1,8	20 14x14x7,5h	0,002	2200	0,12
01 011 016	16	a16 b1,9	20 16x16x8,5h	0,002	1400	0,12
01 011 018	18	a18 b2,3	20 18x18x8,5h	0,003	1200	0,12
01 011 022	22	a22 b3	10 22x22x6h	0,003	500	0,12
01 011 026	26	a26 b3,7	50 26x26x24h	0,016	300	0,12
01 011 030	30	a30 b4,1	25 30x30x15h	0,014	200	0,12
01 011 035	35	a35 b5,1	25 35x35x15h	0,018	125	0,12
01 011 040	40	a40 b5,2	25 40x40x15h	0,024	125	0,12
01 011 045	45	a45 b5,5	25 45x45x17h	0,034	600	1,10
01 011 052	52	a52 b6,6	25 52x52x19h	0,051	350	0,96
01 011 065	65	a66 b6	5 66x66x9h	0,039	130	0,74

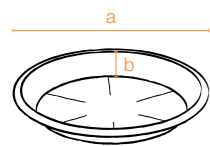

# Sottovaso classic

Superficie opaca / Matt finished  
Surface opaque / Matt-Oberfläche

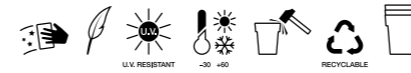

**001**  
terracotta/terracotta colour  
couleur terre/farbe terrakotta



**005**  
antracite/anthracite  
anthracite/anthrazitgrau

codice senza colore code without colour	Cm	dimensioni dimensions	Confezione minima Minimum package	m <sup>3</sup>	pezzi pallet pcs pallet	m <sup>3</sup>
01 011 012	12	a12 b1,5	100 12x12x28h	0,004	2800	0,12
01 011 014	14	a14 b1,8	100 14x14x32h	0,006	2200	0,12
01 011 016	16	a16 b1,9	100 16x16x32h	0,008	1400	0,12
01 011 018	18	a18 b2,3	100 18x18x32h	0,010	1200	0,12
01 011 020	20	a20 b2,9	50 20x20x20h	0,008	700	0,12
01 011 022	22	a22 b3	50 22x22x24h	0,012	500	0,12
01 011 024	24	a24 b3,6	50 24x24x20h	0,012	450	0,12
01 011 026	26	a26 b3,7	50 26x26x24h	0,016	300	0,12
01 011 028	28	a28 b4,1	50 28x28x24h	0,019	300	0,12
01 011 030	30	a30 b4,1	25 30x30x15h	0,014	200	0,12
01 011 035	35	a35 b5,1	25 35x35x15h	0,018	125	0,12
01 011 040	40	a40 b5,2	25 40x40x15h	0,024	125	0,12
01 011 045	45	a45 b5,5	25 45x45x17h	0,034	600	1,10
01 011 052	52	a52 b6,6	25 52x52x19h	0,051	350	0,96
01 011 065	65	a65 b6	5 65x65x9h	0,039	130	0,74
01 011 080	80	a80 b6,6	5 80x80x10h	0,077	130	1,37

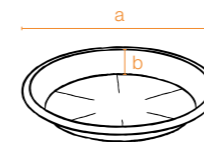



Superficie opaca  
Matt finished  
Surface opaque  
Matt-Oberfläche



## Quadro colour



**403**  
corda/cord  
corde/seil



**406**  
bruno/brown  
brun/braun



**408**  
cacao/cocoa  
cacao/kakao



**Sottovaso**  
pagina 154

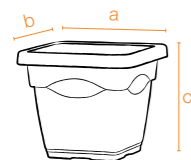

codice senza colore code without colour	Cm	dimensioni dimensions	litri liters		Confezione minima Minimum package	m <sup>3</sup>	pezzi pallet pcs pallet	m <sup>3</sup>
01 007 032	32	a32 b32 c28	14	27	10 32x32x49h	0,05	210 80x120x115h	1,10
01 007 038	38	a38 b38 c33,5	25	33	10 38x38x56h	0,08	180 80x120x110h	1,06
01 007 045	45	a45 b45 c40	42	38	10 45x45x69h	0,14	200 100x120x212h	2,54



Superficie opaca  
Matt finished  
Surface opaque  
Matt-Oberfläche



## Quadro classic



**001**  
terracotta/terracotta colour  
couleur terre/farbe terrakotta



**005**  
antracite/anthracite  
anthracite/anthrazitgrau



**Sottovaso**  
pagina 154

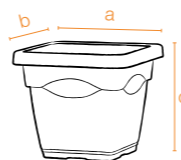

codice senza colore code without colour	Cm	dimensioni dimensions	litri liters		Confezione minima Minimum package	m <sup>3</sup>	pezzi pallet pcs pallet	m <sup>3</sup>
01 007 032	32	a32 b32 c28	14	27	10 32x32x49h	0,05	210 80x120x115h	1,10
01 007 038	38	a38 b38 c33,5	25	33	10 38x38x56h	0,08	180 80x120x110h	1,06
01 007 045	45	a45 b45 c40	42	38	10 45x45x69h	0,14	200 100x120x212h	2,54

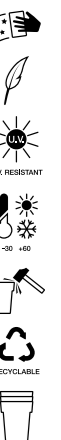
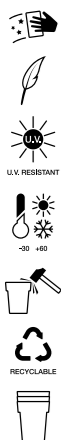



Superficie opaca  
Matt finished  
Surface opaque  
Matt-Oberfläche



## Cassettone colour



**403**

corda/cord  
corde/seil



**406**

bruno/brown  
brun/braun



**408**

cacao/cocoa  
cacao/kakao



**Sottocassettone**  
pagina 155

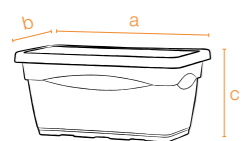

codice senza colore code without colour	Cm	dimensioni dimensions	litri liters		Confezione minima Minimum package	m <sup>3</sup>	pezzi pallet pcs pallet	m <sup>3</sup>
01 008 060	60	a60 b32 c27,5	31	60	5 60x32x37h	0,07	420 100x120x224h	2,69
01 008 080	80	a80 b37 c32,8	60	80	5 80x37x43h	0,12	210 80x120x224h	2,15
01 008 100	100	a100 b40 c37,5	92	100	5 100x40x54h	0,21	100 100x120x228h	2,74



Superficie opaca  
Matt finished  
Surface opaque  
Matt-Oberfläche



## Cassettone classic



**001**

terracotta/terracotta colour  
couleur terre/farbe terrakotta



**005**

antracite/anthracite  
anthracite/anthrazitgrau



**Sottocassettone**  
pagina 155

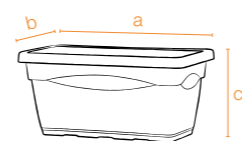

codice senza colore code without colour	Cm	dimensioni dimensions	litri liters		Confezione minima Minimum package	m <sup>3</sup>	pezzi pallet pcs pallet	m <sup>3</sup>
01 008 060	60	a60 b32 c27,5	31	60	5 60x32x37h	0,07	420 100x120x224h	2,69
01 008 080	80	a80 b37 c32,8	60	80	5 80x37x43h	0,12	210 80x120x224h	2,15
01 008 100	100	a100 b40 c37,5	92	100	5 100x40x54h	0,21	100 100x120x228h	2,74

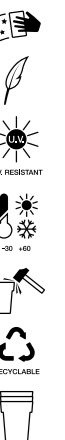

# Sottovaso Quadro

colour

Superficie opaca / Matt finished  
Surface opaque / Matt-Oberfläche



**403**  
corda/cord  
corde/seil

**406**  
bruno/brown  
brun/braun

**408**  
cacao/cocoa  
cacao/kakao

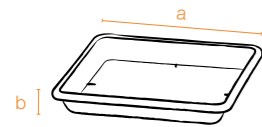

codice senza colore code without colour	Cm	dimensioni dimensions	Confezione minima Minimum package	m <sup>3</sup>	pezzi pallet pcs pallet	m <sup>3</sup>
01 013 027	27	a27 b4	10 27x27x11h	0,01	140 60x40x50h	0,12
01 013 033	33	a33 b5	10 33x33x13h	0,01	70 60x40x50h	0,12
01 013 038	38	a37,5 b6	10 38x38x16h	0,02	50 60x40x50h	0,12

# Sottocassettone

colour

Superficie opaca / Matt finished  
Surface opaque / Matt-Oberfläche

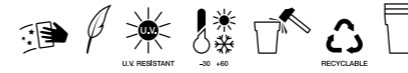

**403**  
corda/cord  
corde/seil

**406**  
bruno/brown  
brun/braun

**408**  
cacao/cocoa  
cacao/kakao

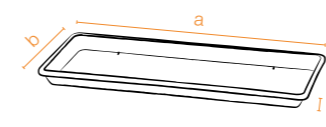

codice senza colore code without colour	Cm	dimensioni dimensions	Confezione minima Minimum package	m <sup>3</sup>	pezzi pallet pcs pallet	m <sup>3</sup>
01 014 060	60	a56 b28 c4,3	5 56x28x7h	0,01	60 60x40x50h	0,12
01 014 080	80	a75 b32 c5,1	5 75x33x9h	0,02	285 80x120x115h	1,10
01 014 100	100	a95 b35 c5,2	5 95x35x11h	0,03	160 80x120x115h	1,10

# Sottovaso Quadro

Superficie opaca / Matt finished  
Surface opaque / Matt-Oberfläche

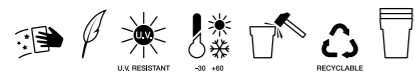

**001**  
terracotta/terracotta colour  
couleur terre/farbe terrakotta

**005**  
antracite/anthracite  
anthracite/anthrazitgrau

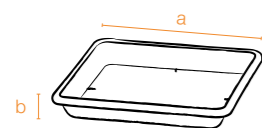

codice senza colore code without colour	Cm	dimensioni dimensions	Confezione minima Minimum package	m <sup>3</sup>	pezzi pallet pcs pallet	m <sup>3</sup>
01 013 027	27	a27 b4	10 27x27x11h	0,01	140 60x40x50h	0,12
01 013 033	33	a33 b5	10 33x33x13h	0,01	70 60x40x50h	0,12
01 013 038	38	a37,5 b6	10 38x38x16h	0,02	50 60x40x50h	0,12

# Sottocassettone

Superficie opaca / Matt finished  
Surface opaque / Matt-Oberfläche

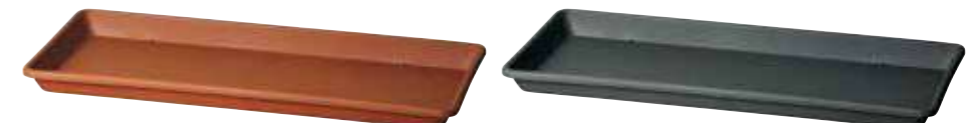
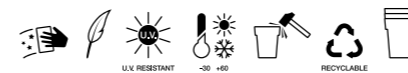

**001**  
terracotta/terracotta colour  
couleur terre/farbe terrakotta

**005**  
antracite/anthracite  
anthracite/anthrazitgrau

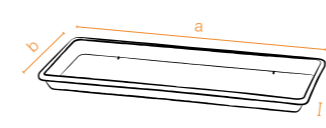

codice senza colore code without colour	Cm	dimensioni dimensions	Confezione minima Minimum package	m <sup>3</sup>	pezzi pallet pcs pallet	m <sup>3</sup>
01 014 060	60	a56 b28 c4,3	5 56x28x7h	0,01	60 60x40x50h	0,12
01 014 080	80	a75 b32 c5,1	5 75x33x9h	0,02	285 80x120x115h	1,10
01 014 100	100	a95 b35 c5,2	5 95x35x11h	0,03	160 80x120x115h	1,10



# Cassetta mare colour



Superficie opaca  
Matt finished  
Surface opaque  
Matt-Oberfläche



**407**  
salvia/sage  
sauge/salbei



**409**  
malva/mauve  
mauve/malve



**415**  
terra di Siena/terra di siena  
terra di siena/terra di siena



**414**  
fog grey/fog grey  
brouillard gris/Nebel grau



**Sottocassetta**  
pagina 168

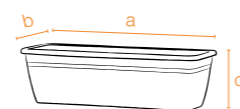

codice senza colore code without colour	Cm	dimensioni dimensions	litri liters	Confezione minima Minimum package	m <sup>3</sup>	pezzi pallet pcs pallet	m <sup>3</sup>	accessori accessories
01 004 040	40	a:40 b:17 c:14,5	6	10 40x17x30h	0,02	700 80x120x115h	1,10	
01 004 050	50	a:50 b:17 c:14,5	8	10 50x17x30h	0,02	450 80x120x118h	1,13	
01 004 060	60	a:60 b:17 c:14,5	10	10 60x17x30h	0,03	450 80x120x115h	1,10	



Superficie opaca  
Matt finished  
Surface opaque  
Matt-Oberfläche



## Cassetta mare colour



**022**

bianco/white  
blanc/weiß



**403**

corda/cord  
corde/seil



**406**

bruno/brown  
brun/braun



**408**

cacao/cocoa  
cacao/kakao



**018**

ciclamino/cyclamen  
cyclamen/zyklamfarbe



**019**

lilla/lilac  
lilas/lila



**404**

cedro/cedar  
cèdre/zeder



**Sottocassetta**  
pagina 168

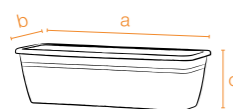

supporto mare  
pagina 167

codice senza colore code without colour	Cm	dimensioni dimensions	litri liters	Confezione minima Minimum package	pezzi pallet pcs pallet	accessori accessories
01 004 040	40	a40 b17 c14,5	6	10 40x17x30h 0,02	700 80x120x115h 1,10	
01 004 050	50	a50 b17 c14,5	8	10 50x17x30h 0,02	450 80x120x118h 1,13	
01 004 060	60	a60 b17 c14,5	10	10 60x17x30h 0,03	450 80x120x115h 1,10	
01 004 080	80	a80 b17 c14,5	12	10 80x17x30h 0,04	240 80x120x105h 1,01	



Superficie opaca  
Matt finished  
Surface opaque  
Matt-Oberfläche



## Cassetta mare classic



**001**

terracotta/terracotta colour  
couleur terre/farbe terrakotta



**005**

antracite/anthracite  
anthracite/anthrazitgrau



**Sottocassetta**  
pagina 168

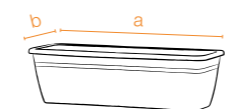

supporto mare  
pagina 167

codice senza colore code without colour	Cm	dimensioni dimensions	litri liters	Confezione minima Minimum package	pezzi pallet pcs pallet	accessori accessories
01 004 040	40	a40 b17 c14,5	6	10 40x17x30h 0,02	700 80x120x115h 1,10	
01 004 050	50	a50 b17 c14,5	8	10 50x17x30h 0,02	450 80x120x118h 1,13	
01 004 060	60	a60 b17 c14,5	10	10 60x17x30h 0,03	450 80x120x115h 1,10	
01 004 080	80	a80 b17 c14,5	12	10 80x17x30h 0,04	240 80x120x105h 1,01	





Superficie opaca  
Matt finished  
Surface opaque  
Matt-Oberfläche



Superficie opaca  
Matt finished  
Surface opaque  
Matt-Oberfläche



## Cassetta Cortina colour

## Cassetta Cortina classic



**022**  
bianco/white  
blanc/weiß



**406**  
bruno/brown  
brun/braun



**018**  
ciclamino/cyclamen  
cyclamen/zyklamfarbe



**404**  
cedro/cedar  
cèdre/zeder



**Sottocassetta**  
pagina 168



**001**  
terracotta/terracotta colour  
couleur terre/farbe terrakotta



**005**  
antracite/anthracite  
anthracite/anthrazitgrau



**Sottocassetta**  
pagina 168

codice senza colore code without colour	Cm	dimensioni dimensions			litri liters		Confezione minima Minimum package			m <sup>3</sup>	pezzi pallet pcs pallet		m <sup>3</sup>
01 104 040	40	a40	b18	c14	10	40	5	40x18x22h	0,01	480	80x120x106h	1,08	
01 104 060	60	a60	b18	c14	15	60	5	60x18x22h	0,02	320	80x120x106h	1,08	
01 104 080	80	a80	b18	c14	20	80	5	80x18x22h	0,03	240	80x120x106h	1,08	
01 104 100	100	a100	b18	c14	25	100	5	100x18x22h	0,04	160	80x120x106h	1,08	

codice senza colore code without colour	Cm	dimensioni dimensions			litri liters		Confezione minima Minimum package			m <sup>3</sup>	pezzi pallet pcs pallet		m <sup>3</sup>
01 104 040	40	a40	b18	c14	10	40	5	40x18x22h	0,01	480	80x120x106h	1,08	
01 104 060	60	a60	b18	c14	15	60	5	60x18x22h	0,02	320	80x120x106h	1,08	
01 104 080	80	a80	b18	c14	20	80	5	80x18x22h	0,03	240	80x120x106h	1,08	
01 104 100	100	a100	b18	c14	25	100	5	100x18x22h	0,04	160	80x120x106h	1,08	

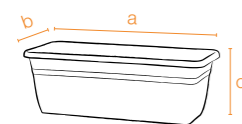



# Cassetta Tirol

Superficie opaca / Matt finished  
Surface opaque / Matt-Oberfläche

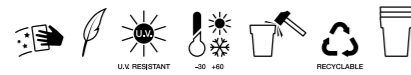

"La cassetta Tirol contiene davvero tanta terra e riesco a coltivare molte varietà di piante."  
"The balcony box Tirol really contains a lot of compost so I can cultivate many plant varieties"  
"La jardinière Tirol contient beaucoup de terre et je peux cultiver toute variété de plantes"  
"Der Blumenkasten Tirol enthält wirklich viel Erde und ich kann viele Pflanzensorten züchten."

Linda



001

terracotta/terracotta colour  
couleur terre/farbe terrakotta



005

antracite/anthracite  
anthracite/anthrazitgrau



Sottocassetta  
pagina 168

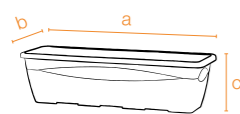

codice senza colore code without colour	Cm	dimensioni dimensions	litri liters	Confezione minima Minimum package	m <sup>3</sup>	pezzi pallet pcs pallet	m <sup>3</sup>
01 006 040	40	a40 b20 c16	8	40	10	40x20x31h	0,02
01 006 050	50	a50 b20 c16	10,5	50	10	50x20x31h	0,03
01 006 060	60	a60 b20 c16	13	60	10	60x20x31h	0,03



100 cm  
fino a / up to / jusqu'à les / bis



Superficie opaca  
Matt finished  
Surface opaque  
Matt-Oberfläche

# Cassetta Portofino colour



022

bianco/white  
blanc/weiß



406

bruno/brown  
brun/braun



misure 80 - 100  
sizes 80 - 100



018

ciclamino/cyclamen  
cyclamen/zyklamfarbe



404

cedro/cedar  
cèdre/zeder

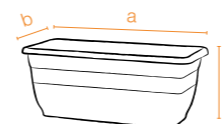

codice senza colore code without colour	Cm	dimensioni dimensions	litri liters	Confezione minima Minimum package	m <sup>3</sup>	pezzi pallet pcs pallet	m <sup>3</sup>
01 105 040	40	a40 b20 c16,5	13	5	40x20x32h	0,02	240 80x120x110h 1,06
01 105 060	60	a60 b20 c16,5	20	5	60x20x32h	0,03	160 80x120x110h 1,06
01 105 080	80	a80 b20 c16,5	26	5	80x20x32h	0,05	120 80x120x110h 1,06
01 105 100	100	a100 b20 c16,5	33	5	100x20x32h	0,06	80 80x120x110h 1,06





Superficie opaca  
Matt finished  
Surface opaque  
Matt-Oberfläche



# Cassetta Portofino classic



**001**  
terracotta/terracotta colour  
couleur terre/farbe terrakotta



**005**  
antracite/anthracite  
anthracite/anthrazitgrau

misure 80 - 100  
sizes 80 - 100

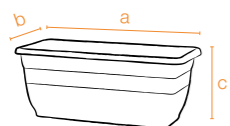

codice senza colore code without colour	Cm	dimensioni dimensions			litri liters	Confezione minima Minimum package	m <sup>3</sup>	pezzi pallet pcs pallet	m <sup>3</sup>
01 105 040	40	a 40	b 20	c 16,5	13	5 40x20x32h	0,02	240 80x120x110h	1,06
01 105 060	60	a 60	b 20	c 16,5	20	5 60x20x32h	0,03	160 80x120x110h	1,06
01 105 080	80	a 80	b 20	c 16,5	26	5 80x20x32h	0,05	120 80x120x110h	1,06
01 105 100	100	a 100	b 20	c 16,5	33	5 100x20x32h	0,06	80 80x120x110h	1,06

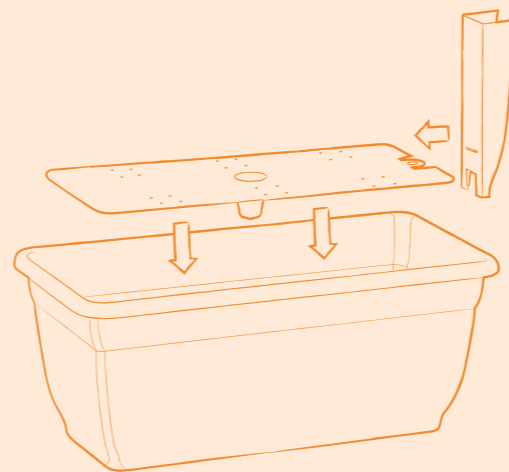

diffusione dell'acqua  
per osmosi  
water diffusion through  
osmosis's effect  
diffusion de l'eau par  
osmose  
Wasserdiffusion durch  
Osmose

beccuccio per  
inserimento dell'acqua  
spout for water insertion  
bec pour l'introduction  
de l'eau  
Füllschacht zur  
Wasserversorgung

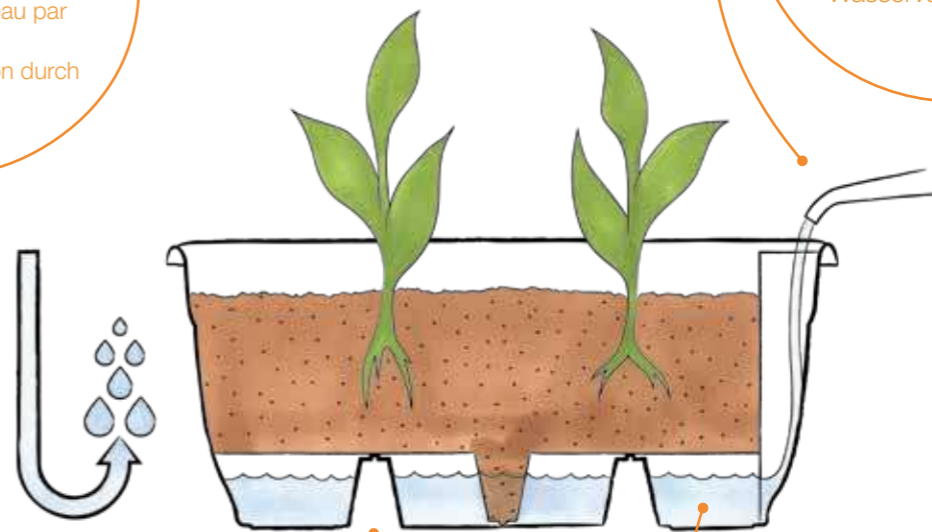

foro di drenaggio per  
l'acqua in eccesso  
drainage bore for water's  
excess  
trou de drainage pour  
l'eau en excès  
Entwässerungsloch

riserva d'acqua  
water reserve  
réserve d'eau  
Wasser-Reservoir



# Cassetta Coste

Superficie opaca / Matt finished  
Surface opaque / Matt-Oberfläche



**001**  
terracotta/terracotta colour  
couleur terre/farbe terrakotta



**005**  
antracite/anthracite  
anthracite/anthrazitgrau

diffusione dell'acqua per osmosi  
water diffusion through osmosis's effect  
diffusion de l'eau par osmose  
Wasserdiffusion durch Osmose

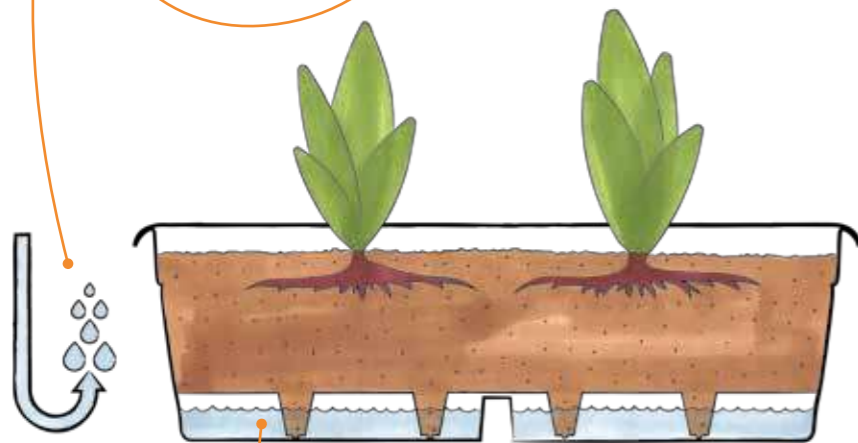

riserva d'acqua  
water reserve  
réserve d'eau  
Wasser-Reservoir

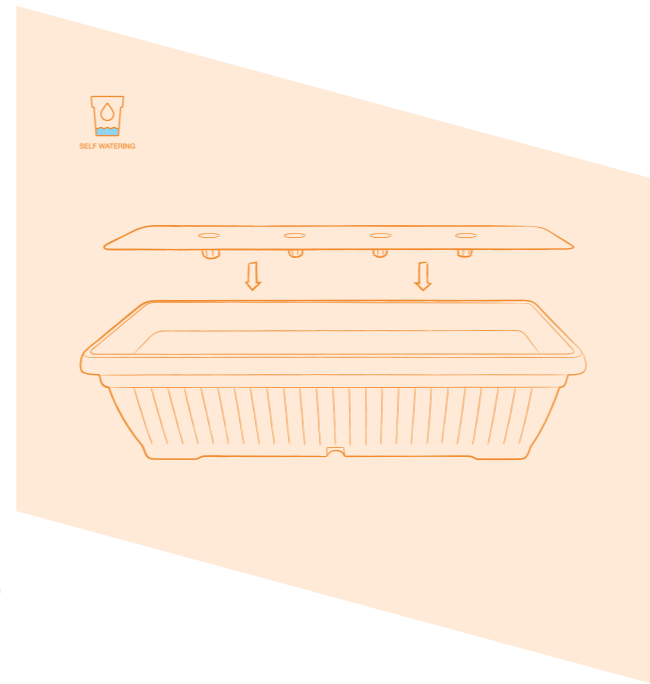

supporto coste  
pagina 167

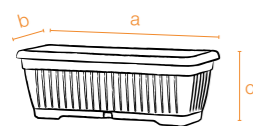

codice senza colore code without colour	Cm	dimensioni dimensions	litri liters	Confezione minima Minimum package	pezzi pallet pcs pallet	accessori accessories
01 005 040	40	a40 b20 c17	8	10 40x20x43h	360 80x120x115h	1,10
01 005 050	50	a50 b20 c17	10,5	10 50x20x43h	270 80x120x115h	1,10
01 005 060	60	a60 b20 c17	13	10 60x20x43h	240 80x120x118h	1,13

# kit balcone Coste

Superficie opaca / Matt finished  
Surface opaque / Matt-Oberfläche

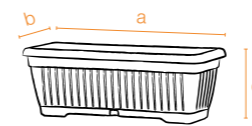
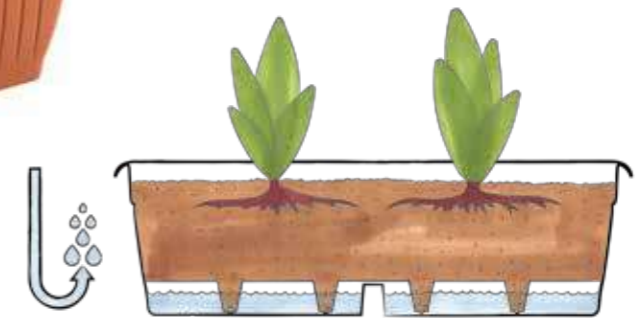

codice senza colore code without colour	Cm	dimensioni dimensions	Confezione minima Minimum package	pezzi pallet pcs pallet
01 016 040	40	a40 b27 c17,3	104 80x60x115h	0,55
01 016 050	50	a50 b20 c17,3	78 80x60x115h	0,55
01 016 060	60	a60 b20 c17,3	78 80x60x115h	0,55

# supporto Coste



codice senza colore code without colour	Cm	Confezione minima Minimum package
10 901 040	40	10 40x28x30h
10 901 050	50	10 50x28x30h
10 901 060	60	10 60x28x30h

# supporto Mare

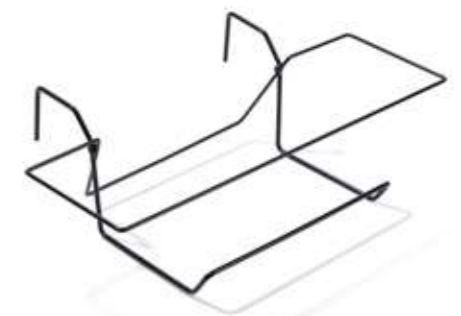

codice senza colore code without colour	Cm	Confezione minima Minimum package
10 900 040	40	10 46x30x24h
10 900 050	50	10 56x30x24h
10 900 060	60	10 66x30x24h
10 900 080	80	10 86x30x24h



## Sottocassetta colour

Superficie opaca  
Matt finished  
Surface opaque  
Matt-Oberfläche



**022**  
bianco/white  
blanc/weiß



**403**  
corda/cord  
corde/seil



**406**  
bruno/brown  
brun/braun



**408**  
cacao/cocoa  
cacao/kakao



**018**  
ciclamino/cyclamen  
cyclamen/zyklamfarbe



**019**  
lilla/lilac  
lilas/lila



**404**  
cedro/cedar  
cèdre/zeder



**407**  
salvia/sage  
saugé/salbei



**409**  
malva/mauve  
mauve/malve



**415**  
terra di Siena/terra di siena  
terra di siena/terra di siena



**414**  
fog grey/fog grey  
brouillard gris/Nebel grau

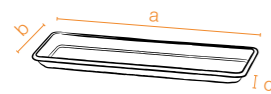

codice senza colore code without colour	Cm	dimensioni dimensions	litri liters	Confezione minima Minimum package	m <sup>3</sup>	pezzi pallet pcs pallet	m <sup>3</sup>
01 012 040	40	a38 b19 c3,2	2	10 38x19x15h	0,01	240	0,12
01 012 050	50	a48 b19 c3,2	3	10 48x19x15h	0,01	160	0,12
01 012 060	60	a58 b19 c3,2	5	10 58x19x15h	0,01	160	0,12
01 012 080	80	a78 b19 c3,2	8	10 78x19x15h	0,02	1080	1,10
01 012 100	100	a98 b19 c3,2	10	10 98x19x15h	0,02	720	1,10



Superficie opaca  
Matt finished  
Surface opaque  
Matt-Oberfläche

## Sottocassetta classic



**001**  
terracotta/terracotta colour  
couleur terre/farbe terrakotta



**005**  
antracite/anthracite  
anthracite/anthrazitgrau

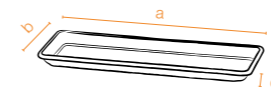

codice senza colore code without colour	Cm	dimensioni dimensions	litri liters	Confezione minima Minimum package	m <sup>3</sup>	pezzi pallet pcs pallet	m <sup>3</sup>
01 012 040	40	a38 b19 c3,2	2	10 38x19x15h	0,01	240	0,12
01 012 050	50	a48 b19 c3,2	3	10 48x19x15h	0,01	160	0,12
01 012 060	60	a58 b19 c3,2	5	10 58x19x15h	0,01	160	0,12
01 012 080	80	a78 b19 c3,2	8	10 78x19x15h	0,02	1080	1,10
01 012 100	100	a98 b19 c3,2	10	10 98x19x15h	0,02	720	1,10



disponibile anche:  
also available:  
aussi disponible:  
verfügbar auch:



## Espositore Hydral

Codice ESPOSITORE:  
Code for empty Hydral display:  
Code du présentoir vide pour les Hydral:  
Kode für den leeren Ständer des Hydrals:  
**10919830000**

L'espositore è adatto per contenere i nostri articoli HYDRAL nelle seguenti misure e quantità:

The Display is suitable to hold our HYDRAL in the following sizes and quantities:

Le présentoir est apte à contenir nos articles HYDRAL dans les tailles et quantités suivantes:

Der Präsentationsständer ist für unseren Artikel HYDRAL geeignet und kann folgende Größen und Mengen enthalten:

codice senza colore code without colour	descrizione	quantità totale consigliata	minimo vendita per colore
28 107 018	hydral 18	20	20
28 107 023	hydral 23	20	10
28 107 028	hydral 28	20	10
28 107 033	hydral 33	20	5
28 107 038	hydral 38	20	8



## Display

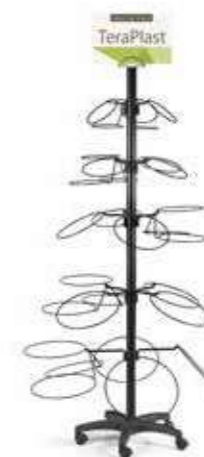

disponibile anche: / also available:  
aussi disponible: / verfügbar auch:



## Espositore cilindri e sottovasi

Codice ESPOSITORE:  
Code for empty Cylinder and Saucers display:  
Code du présentoir vide pour les Cylindres et Soucoupes:  
Kode für den leeren Ständer der Zylinder und Untersetzer:  
**10915830000**

L'espositore è adatto per contenere i nostri articoli CILINDRO INIEZIONE e SOTTOVASO INIEZIONE nelle seguenti misure e quantità:

The Display is suitable to hold our ITEMS CYLINDER INJECTION AND SAUCER INJECTION in the following sizes and quantities:

Le présentoir est apte à contenir nos articles CYLINDRE INJECTÉ et SOUCOUPES dans les tailles et quantités suivantes:

Der Präsentationsständer ist für unseren Artikel INJEKTION ZYLINDER TOPF und UNTERSETZER RUND in den folgenden Größen und Mengen als Behälter geeignet:

codice senza colore code without colour	descrizione	quantità totale consigliata	minimo vendita per colore
01 001 020	Cilindro cm 20	10	20
01 001 025	Cilindro cm 25	10	10
01 001 030	Cilindro cm 30	10	10
01 001 035	Cilindro cm 35	10	10
01 001 040	Cilindro cm 40	5	10

codice senza colore code without colour	descrizione	quantità totale consigliata	minimo vendita per colore
01 011 018	Sottovaso cm 18	10	100
01 011 022	Sottovaso cm 22	10	50
01 011 026	Sottovaso cm 26	10	50
01 011 030	Sottovaso cm 30	10	25
01 011 035	Sottovaso cm 35	5	25



disponibile anche:  
also available:  
aussi disponible:  
verfügbar auch:



## Espositore cassette e sottocassette

Codice ESPOSITORE:

Code for empty Balcony boxes and saucers display:

Code du présentoir vide pour les cylindres et les soucoupes:

Kode für den leeren Ständer von Zylinder und Untersetzer:

**10918830000**

L'espositore è adatto per contenere le CASSETTE e LE SOTTOCASSETTE INIEZIONE nelle seguenti misure e quantità:

The Display is suitable to contain our items BALCONY BOXES INJECTION AND SAUCER INJECTION in the following sizes and quantities:

Le présentoir est apte à contenir nos articles JARDINIÈRE et SOUCOUPE JARDINIÈRE INJECTÉ dans les tailles et quantités suivantes:

Der Präsentationsständer ist für unseren Artikel BALKONKASTEN und UNTERSETZER BALKONKASTEN in folgenden Größen und Mengen als Behälter geeignet:

codice senza colore code without colour	descrizione	quantità totale consigliata	minimo vendita per colore
01 004 040	Cassetta cm 40	15	10
01 004 050	Cassetta cm 50	15	10
01 004 060	Cassetta cm 60	15	10
01 004 080	Cassetta cm 80	15	10

codice senza colore code without colour	descrizione	quantità totale consigliata	minimo vendita per colore
01 012 040	Sottocassetta cm 40	15	10
01 012 050	Sottocassetta cm 50	15	10
01012060	Sottocassetta cm 60	15	10
01 012 080	Sottocassetta cm 80	15	10

## Espositore cilindri

Codice ESPOSITORE CILINDRI:

Code for Cylinder display:

Code du présentoir pour les Cylindres:

Kode für Zylinderständer:

**10911830000**

L'espositore è adatto per contenere il nostro articolo CILINDRO INIEZIONE nelle seguenti misure e quantità:

The Display is suitable to hold our article CYLINDER INJECTION in the following sizes and quantities:

Le présentoir est apte à contenir notre article CYLINDRE INJECTÉ dans les tailles et quantités suivantes:

Der Präsentationsständer ist für unseren Artikel INJEKTION ZYLINDER TOPF in den folgenden Größen und Mengen als Behälter geeignet:



codice senza colore code without colour	descrizione	quantità totale consigliata	minimo vendita per colore
01 001 020	Cilindro cm 20	40	20
01 001 025	Cilindro cm 25	40	10
01 001 030	Cilindro cm 30	40	10
01 001 035	Cilindro cm 35	40	10
01 001 040	Cilindro cm 40	40	10

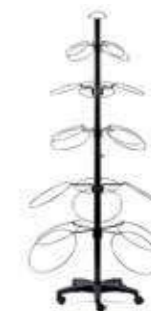

## Espositore sottovasi

Codice ESPOSITORE SOTTOVASI:

Code for Saucer Display:

Code du présentoir pour les Soucoupes:

Kode für Untersetzerständer:

**10909830000**

L'espositore è adatto per contenere il nostro articolo SOTTOVASO ROTONDO INIEZIONE nelle seguenti misure e quantità:

The Display is suitable to hold our article ROUND SAUCER INJECTION in the following sizes and quantities:

Le présentoir est apte à contenir notre article SOUCOUPE RONDE INJECTÉE dans les tailles et quantités suivantes:

Der Präsentationsständer ist für unseren Artikel INJEKTION UNTERSETZER RUND in den folgenden Größen und Mengen als Behälter geeignet:



codice senza colore code without colour	descrizione	quantità totale consigliata	minimo vendita per colore
01 011 012	Sottovaso cm 12	100	100
01 011 014	Sottovaso cm 14	100	100
01 011 016	Sottovaso cm 16	100	100
01 011 018	Sottovaso cm 18	50	100
01 011 020	Sottovaso cm 20	50	50
01 011 022	Sottovaso cm 22	50	50
01 011 024	Sottovaso cm 24	50	50
01 011 026	Sottovaso cm 26	50	50
01 011 028	Sottovaso cm 28	50	50
01 011 030	Sottovaso cm 30	50	25
01 011 035	Sottovaso cm 35	50	25
01 011 040	Sottovaso cm 40	50	25
01 011 045	Sottovaso cm 45	50	25
01 011 052	Sottovaso cm 52	50	25



## Teraplast Marketing support

Teraplast può aiutarti anche per quanto riguarda il punto vendita, offrendo una grande varietà di display e scaffalature espositive. Sono soluzioni ideali perché sono maneggevoli e attrattive per il consumatore finale.

## Teraplast Marketing support

Teraplast may help you also concerning shops, offering a wide range of display solutions and shelves. They are ideal solutions, because they are manageable and eye catching for consumers.



## Teraplast Marketing support

Teraplast kann Ihnen auch im Shop mit einer Vielzahl von Displays und Ausstellungsregale behilflich sein. Es handelt sich um ideale Lösungen, die einfach zu handhaben sind und für den Endverbraucher anziehend wirken.

## Teraplast Marketing support

Au niveau de point de vente Teraplast peut vous aider avec une grande variété de display et présentoirs. Il s'agit de solutions idéales car elles sont faciles à utiliser et attrayant pour le consommateur finale



Un prodotto presentato con **gusto e chiarezza** è un prodotto che comunica **qualità**.

La presentazione delle famiglie di prodotti insieme, coordinati nei colori e nello stile, comunica un marchio forte e affidabile.

I nostri display pallet sono ideali per proporre nuove e interessanti combinazioni di colori.

A **tasteful and clear** product is a product which conveys **quality**.

The presentation of coordinate products in terms of colours improves its visual impact and increases pulse purchases.

Our display pallet are flexible solution suitable for several promotions.



Le produit qui est présenté avec **bon goût et clarté** est un produit qui communique la **qualité**.

La présentation des produits coordonnés en rapport aux couleurs renforce l'impact visuel du produit et il augmente les achats d'impulsion.

Nos palettes display offrent des solutions flexibles et adaptées à nombreux promotions.

Ein Produkt das **gut** und in einer **geordneten Art** präsentiert wird betont auch die **Qualität**.

Die Ausstellung der Produkte mit gut aufeinander abgestimmte Farben hat optisch einen positiven Einfluss und erhöht die Impulskäufe.

Unsere Displaypaletten sind flexible Lösungen die sich gut für Promotionen eignen.





# TeraPlast Marketing support

Scaffali supporto alla vendita  
Exhibition shelves  
Support à la vente  
Regale zur Verkaufsunterstützung

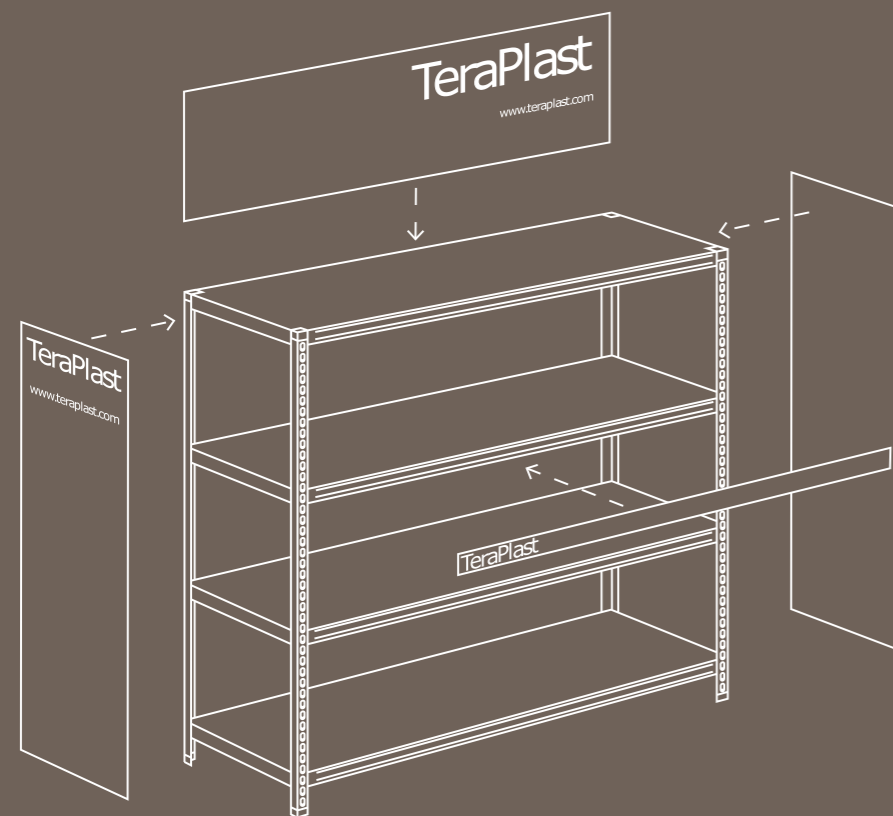

60 cm

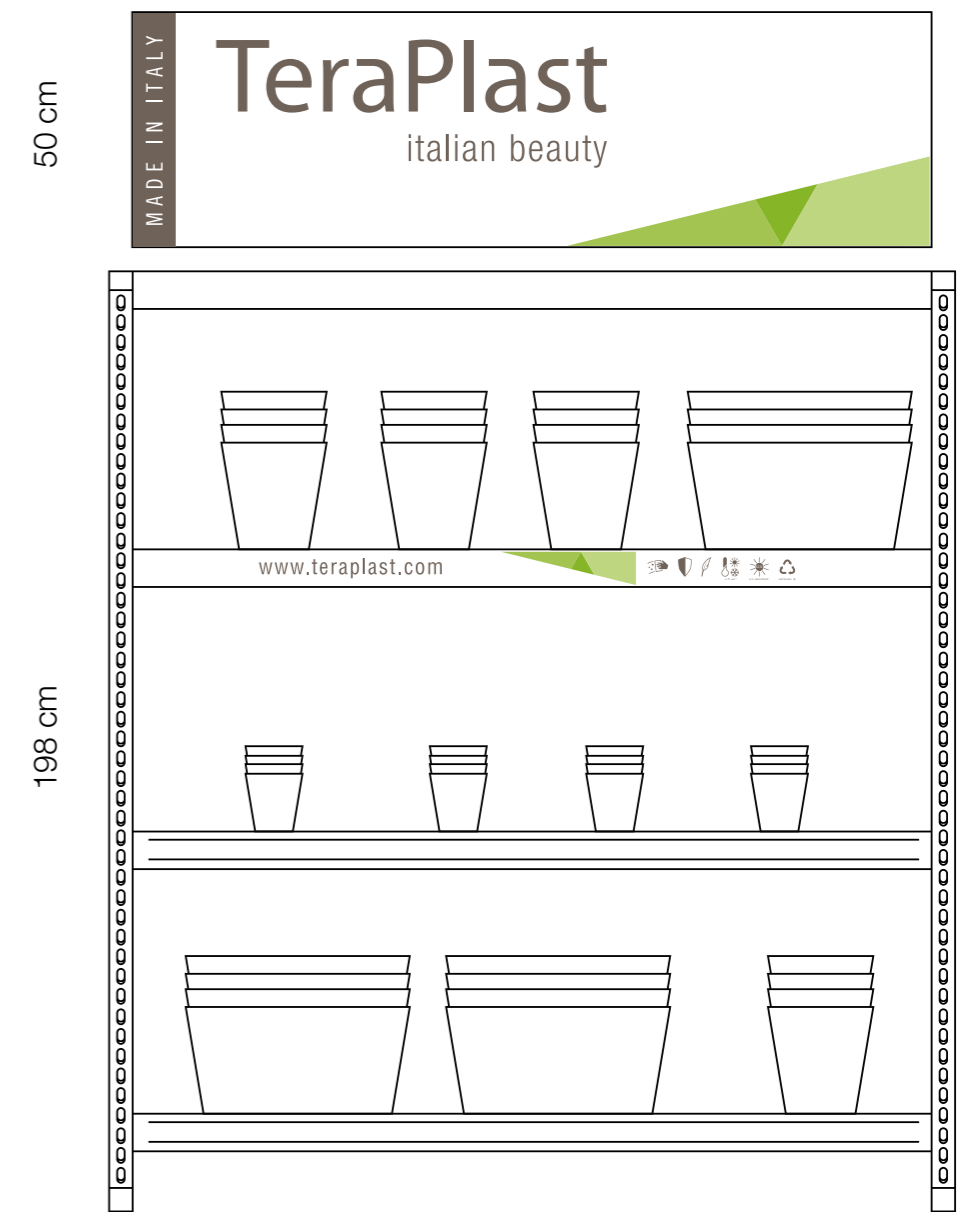

50 cm

198 cm

187 cm

# display kit balcone **Mare** 1 pz



**022**  
bianco/white  
blanc/weiß

**403**  
corda/cord  
corde/seil

**406**  
bruno/brown  
brun/braun

**408**  
cacao/cocoa  
cacao/kakao



**018**  
ciclaminò/cyclamen  
cyclamen/zyklamfarbe

**019**  
lilla/lilac  
lilas/lila

**404**  
cedro/cedar  
cèdre/zeder



**001**  
terracotta/terracotta colour  
couleur terre/farbe terrakotta

**005**  
antracite/anthracite  
anthracite/anthrazitgrau

codice senza colore code without colour	Cm	dimensioni dimensions	pezzi pallet pcs pallet	m <sup>3</sup>
01 015 040 022 403 406 408 018 019 404 001 005	40	a40 b17 c14,5	48	80x120x115h 1,10
01 015 050 022 403 406 408 018 019 404 001 005	50	a50 b17 c14,5	42	80x120x115h 1,10
01 015 060 022 403 406 408 018 019 404 001 005	60	a60 b17 c14,5	35	80x120x115h 1,10
01 015 080 403 406 408 001 005	80	a80 b17 c14,5	24	80x120x105h 1,10

# display kit balcone **Mare** 2 pz



**022**  
bianco/white  
blanc/weiß

**403**  
corda/cord  
corde/seil

**406**  
bruno/brown  
brun/braun

**408**  
cacao/cocoa  
cacao/kakao



**018**  
ciclaminò/cyclamen  
cyclamen/zyklamfarbe

**019**  
lilla/lilac  
lilas/lila

**404**  
cedro/cedar  
cèdre/zeder



**001**  
terracotta/terracotta colour  
couleur terre/farbe terrakotta

**005**  
antracite/anthracite  
anthracite/anthrazitgrau

codice senza colore code without colour	Cm	dimensioni dimensions	pezzi pallet pcs pallet	m <sup>3</sup>
01 019 040 022 403 406 408 018 019 404 001 005	40	a40 b17 c14,5	40	80x120x115h 1,10
01 019 050 022 403 406 408 018 019 404 001 005	50	a50 b17 c14,5	35	80x120x115h 1,10
01 019 060 022 403 406 408 018 019 404 001 005	60	a60 b17 c14,5	25	80x120x115h 1,10
01 019 080 403 406 408 001 005	80	a80 b17 c14,5	18	80x120x115h 1,10





**Progetto grafico ed impaginazione:**

Verde Pistacchio - info@verdepistacchio.net

**Le ambientazioni:**

Alexis visual arts - Via Giovanni Dolfin, 8 - 36016 Thiene (VI) - www.alexisvisual.com per pag. 41.

Verde Architettura - via Fumagalli, 7 - 20143 (MI) - www.verdearchitettura.it per pag. 218.

Anymotion - Corso Garibaldi, 81 - 29017 Fiorenzuola D'Arda (PC) pag. 214, 215, 216, 219.

**Foto:**

Photopiù - Via Rivarotta, 165 - 36061 Bassano del Grappa (VI) - www.photopiu.it

BitCreativo di Mazzaro Elia - Via Col di Lana, 10 - 36034 Malo (VI) - www.bitcreativo.it

**Designer:**

favarettoandpartner di pag. 40.

Irina Alekseeva di pag. 206, 207, 208.

---

Dati, foto e caratteristiche non sono impegnativi; Teraplast si riserva di apportare le modifiche che riterrà opportune per migliorare i suoi prodotti.

Tutte le parti di questo catalogo - foto comprese - sono di proprietà di Teraplast. La riproduzione, anche parziale, è vietata in ogni forma e con ogni mezzo.

Data, photos, and characteristics are not binding; Teraplast reserves the right to produce modifications considered necessary to improve its products.

Every part of this catalogue - photos included - is the property of Teraplast. All forms of copying are strictly prohibited.

TeraPlast™ S.p.a.

Via del Progresso, 65 (GPS: Località Conca)  
36070 Castelgomberto (VI) - ITALY  
tel. +39 0445 444 100 - fax +39 0445 444 111  
[www.teraplast.com](http://www.teraplast.com) - [info@teraplast.com](mailto:info@teraplast.com)