

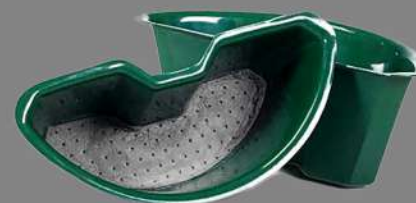

Wiszące Donice i kosze

samonawadniająca!

TerraFlor
piękno czystej formy





BEST	2
BEST CUP	4
BARIST	6
BARIST BASE	8
CESAR	10
WOVEN	12

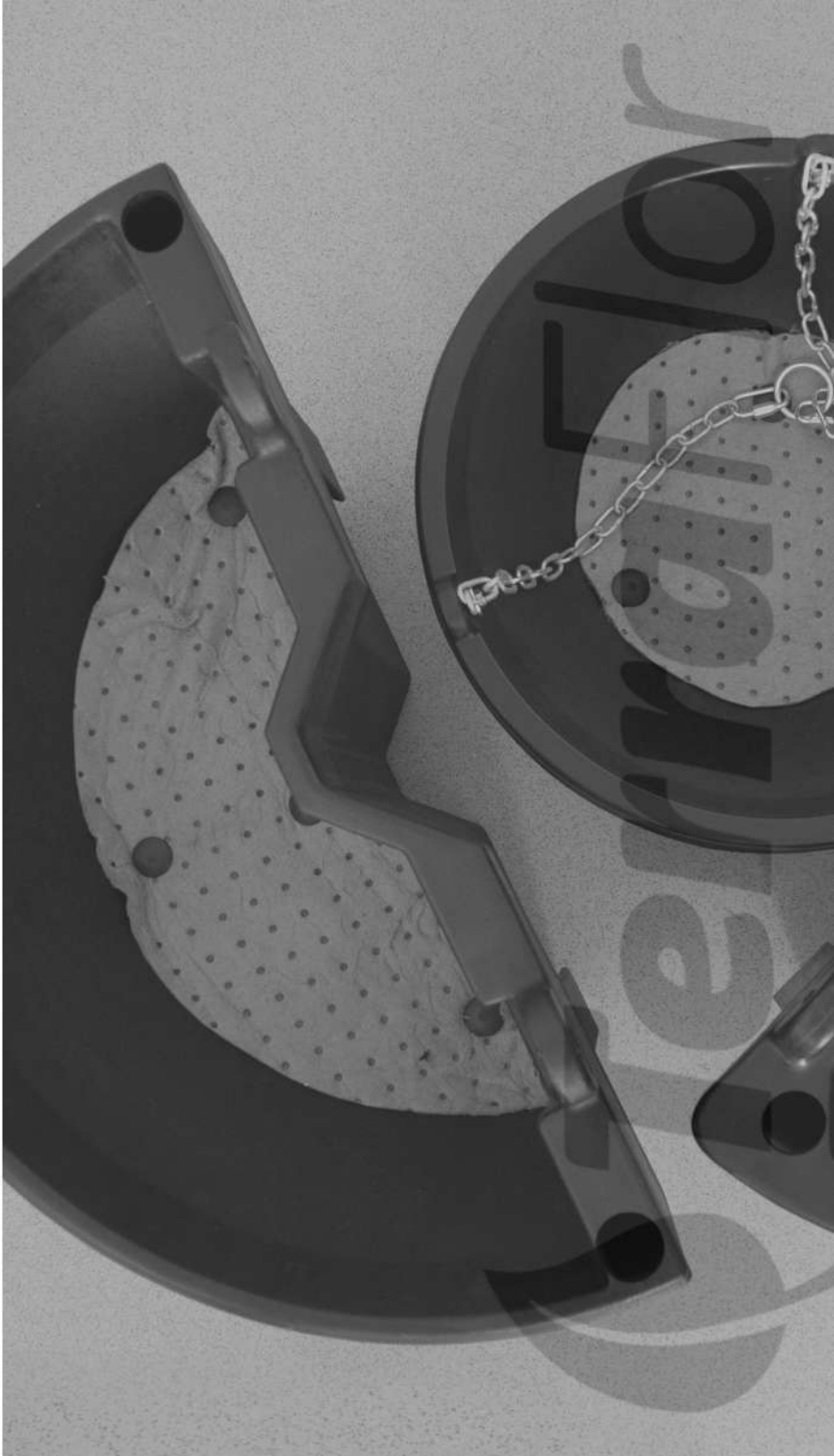



BEST



MODEL	KOD	WYMIARY [MM]	CENA
BEST komplet (2 połówki + mocowanie)	AB UTP-1P	590mm x 270mm	850 zł
wkładka x 2			350 zł
BEST komplet (2 połówki + mocowanie)	AB UTP-2P	800mm x 270mm	1100 zł
wkładka x 2			450 zł

czarny



RAL 9005

ciemna zieleń



RAL 6032

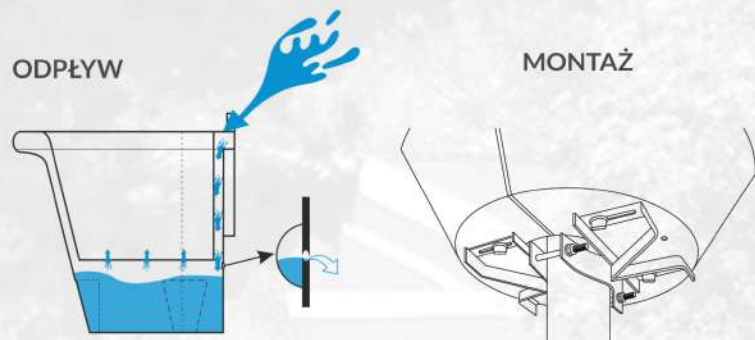

Gwarancja 10 lat

BEST**KARTA** TECHNICZNA

WIDOK Z PRZODU

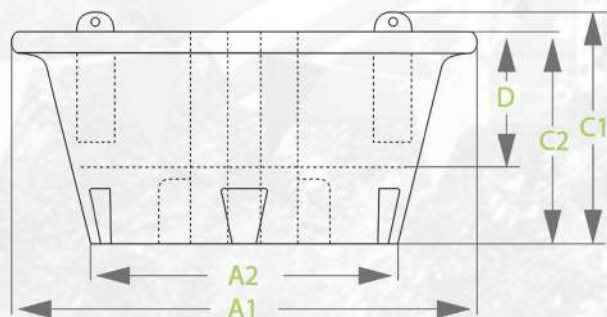

WIDOK Z BOKU

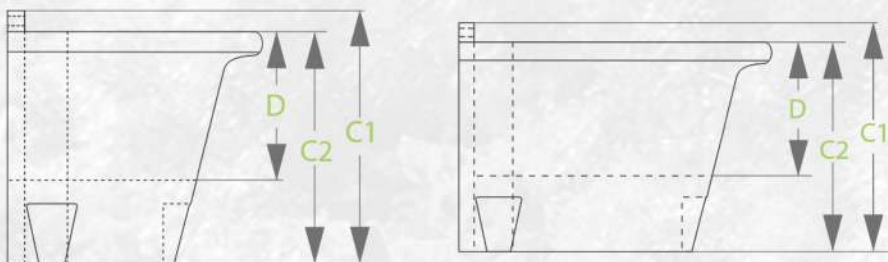
**AB UTP-1P**

A1	szerokość poziomu	590 mm		objętość substratu	▶ 12 l
A2	szerokość dolna	390 mm		zasobnik na wodę	▶ 5 l
B	głębokość poziomu	295 mm		waga przed obsadzeniem	▶ 2,2 kg
C1	wysokość całkowita	295 mm		waga po obsadzeniu	▶ 14 kg
C2	wysokość donicy	270 mm		szacunkowa ilość sadzonek	▶ 5-7 sztuk
D	głębokość wkładu	170 mm		waga uzależniona od rodzaju i wilgotności gleby.	
E	średnica spodu wkładu	410 mm			

AB UTP-2P

A1	szerokość poziomu	800 mm		objętość substratu	▶ 25 l
A2	szerokość dolna	600 mm		zasobnik na wodę	▶ 14 l
B	głębokość poziomu	400 mm		waga przed obsadzeniem	▶ 3,7 kg
C1	wysokość całkowita	295 mm		waga po obsadzeniu	▶ 31 kg
C2	wysokość donicy	270 mm		szacunkowa ilość sadzonek	▶ 10-12
D	głębokość wkładu	170 mm		waga uzależniona od rodzaju i wilgotności gleby.	
E	średnica spodu wkładu	630 mm			

**Gwarancja na 10 lat**



BEST CUP

MODEL	KOD	WYMIARY [MM]	CENA
BEST CUP komplet (2 połówki + mocowanie)	AB CNS-1P	650mm x 300mm	900 zł
wkładka x 2			400 zł

czarny



RAL 9005

ciemna zieleń



RAL 6032



Gwarancja 10 lat



BEST
CUP

KARTA TECHNICZNA

AB CNS-1P

WIDOK Z PRZODU

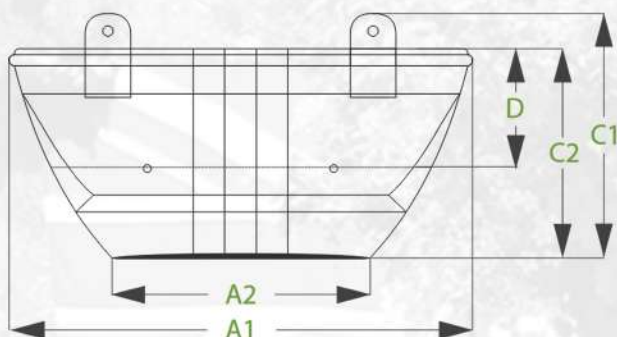

WIDOK Z GÓRY
POŁÓWKA

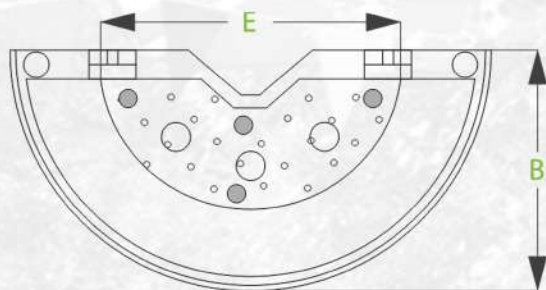

WIDOK Z BOKU

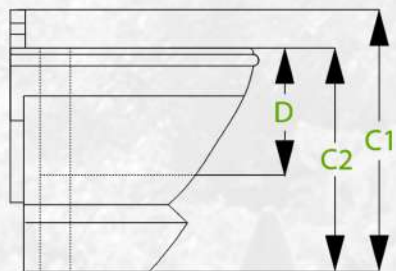

WIDOK Z GÓRY

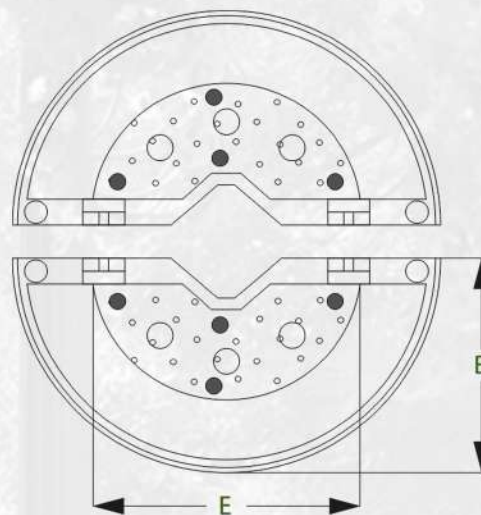

MONTAŻ

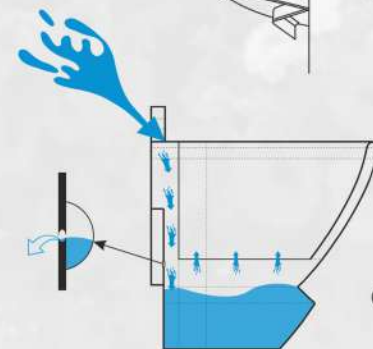
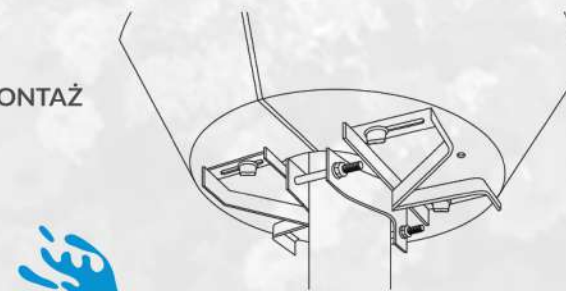

ODPŁYW

A1	szerokość poziomu	650 mm		objętość substratu	▶ 12 litrów
A2	szerokość dolna	370 mm		zasobnik na wodę	▶ 9 litry
B	głębokość poziomu	325 mm		waga przed obsadzeniem	▶ 2,7 kg
C1	wysokość całkowita	350 mm		waga po obsadzeniu	▶ 18 kg
C2	wysokość donicy	300 mm		szacunkowa ilość sadzonek	▶ 5-7 sztuk
D	głębokość wkładu	170 mm		waga uzależniona od rodzaju i wilgotności gleby.	
E	średnica spodu wkładu	430 mm			

Gwarancja na 10 lat



BARIST



MODEL	KOD	WYMIARY [MM]	CENA
BARIST z łańcuchem	AB CHB-1P	470mm x 270mm	430 zł

czarny



RAL 9005

ciemna zieleń



RAL 6032



Gwarancja 10 lat

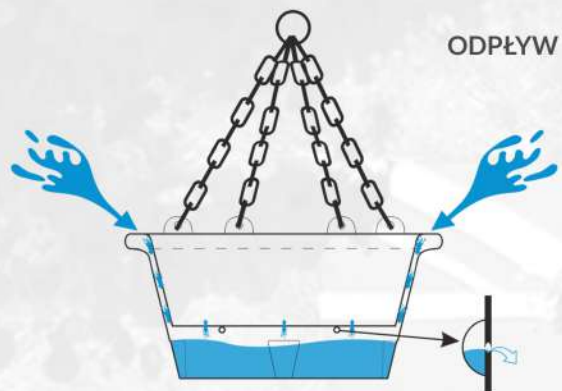





BARIST**KARTA** TECHNICZNA**AB CHB 1P**

ODPŁYW

WIDOK Z PRZODU



- A średnica poziomu **470 mm**
- B średnica dolna **285 mm**
- C wysokość całkowita **270 mm**
- D głębokość wkładu **190 mm**
- E średnica spodu wkładu **290 mm**

-  objętość substratu ► **24 litrów**
-  zasobnik na wodę ► **13 litry**
-  waga przed obsadzeniem ► **3,7 kg**
-  waga po obsadzeniu ► **27 kg** 
-  szacunkowa ilość sadzonek ► **12-15 sztuk**
-  waga uzależniona od rodzaju i wilgotności gleby.

WIDOK Z GÓRY

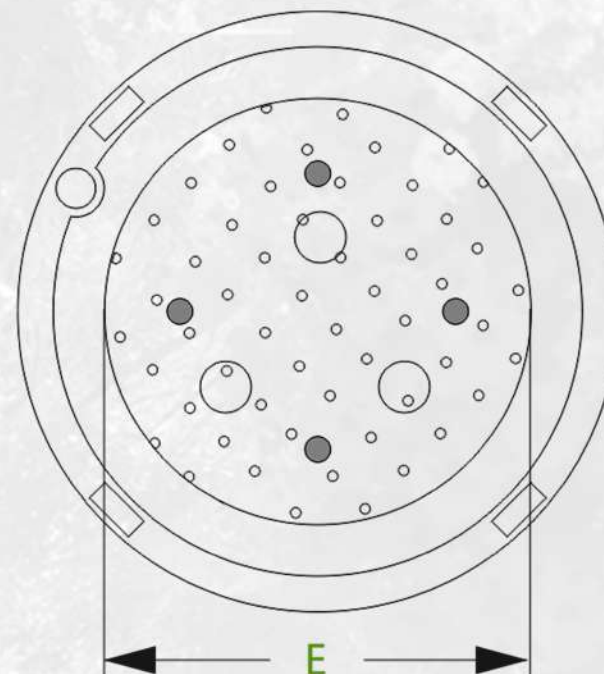
**Gwarancja na 10 lat**



BARIST
BASE



MODEL	KOD	WYMIARY [MM]	CENA
BARIST BASE z łańcuchem	AB CAS-0P	420mm x 240mm	350 zł
BARIST BASE z łańcuchem	AB CAS-1P	530mm x 265mm	630 zł

czarny



RAL 9005

ciemna zieleń



RAL 6032



Gwarancja 10 lat

BARIST BASE

KARTA TECHNICZNA

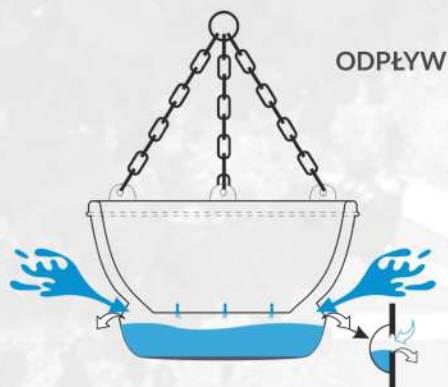

WIDOK Z PRZODU



WIDOK Z GÓRY

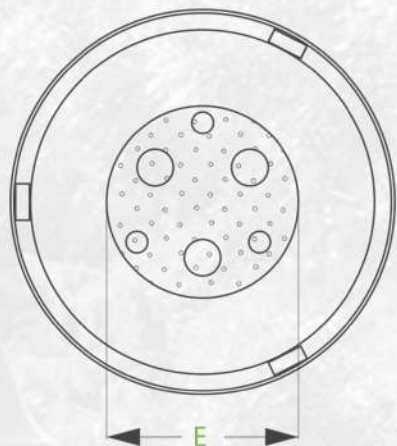

AB CAS-OP

- A średnica poziomu **420 mm**
- B średnica dolna **290 mm**
- C wysokość całkowita **240 mm**
- D głębokość wkładu **150 mm**
- E średnica spodu wkładu **210 mm**

- objętość substratu **▶ 11 litrów**
- zasobnik na wodę **▶ 7 litry**
- waga przed obsadzeniem **▶ 2,3 kg**
- waga po obsadzeniu **▶ 15 kg** ?
- szacunkowa ilość sadzonek **▶ 8-10 sztuk**
- ? waga uzależniona od rodzaju i wilgotności gleby.

AB CAS-1P

- A średnica poziomu **530 mm**
- B średnica dolna **320 mm**
- C wysokość całkowita **265 mm**
- D głębokość wkładu **190 mm**
- E średnica spodu wkładu **290 mm**

- objętość substratu **▶ 24 litrów**
- zasobnik na wodę **▶ 13 litry**
- waga przed obsadzeniem **▶ 3,7 kg**
- waga po obsadzeniu **▶ 27 kg** ?
- szacunkowa ilość sadzonek **▶ 12-15 sztuk**
- ? waga uzależniona od rodzaju i wilgotności gleby.



Gwarancja 10 lat



CESAR



MODEL	KOD	WYMIARY [MM]	CENA
CESAR z łańcuchem	AB IMP-0P	500mm x 320mm	600 zł

czarny

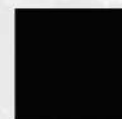

RAL 9005

ciemna zieleń



RAL 6032



piaskowiec



Gwarancja 10 lat

T: +48 68 455 62 69 | E: INFO@TERRA-PL.EU | TERRA-PL.EU



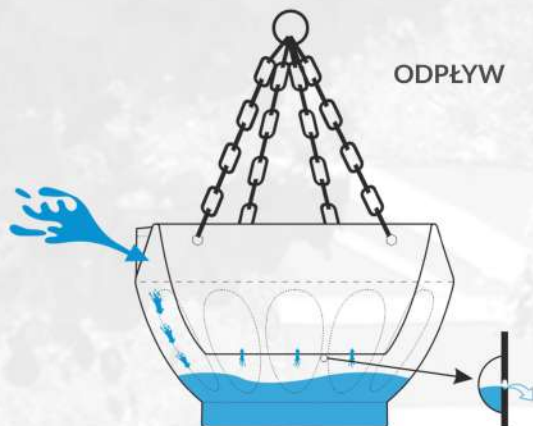

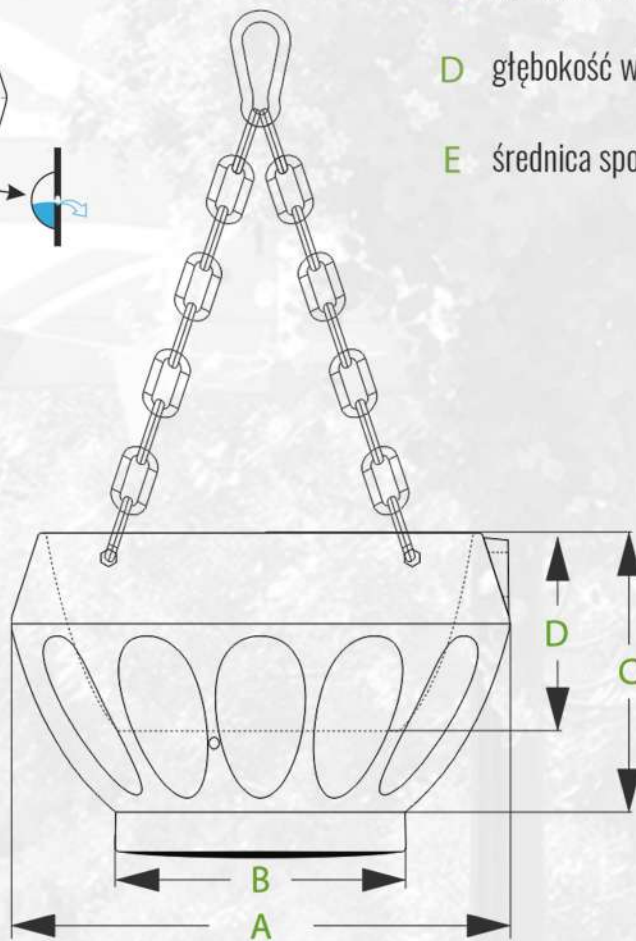

 **TerraFlor**



WIDOK Z PRZODU



- A średnica poziomu **500 mm**
- B średnica dolna **290 mm**
- C wysokość całkowita **320 mm**
- D głębokość wkładu **195 mm**
- E średnica spodu wkładu **290 mm**

-  objętość substratu ► **20 litrów**
-  zasobnik na wodę ► **8 litry**
-  waga przed obsadzeniem ► **4,8 kg**
-  waga po obsadzeniu ► **22 kg** 
-  szacunkowa ilość sadzonek ► **10-12 sztuk**
-  waga uzależniona od rodzaju i wilgotności gleby.

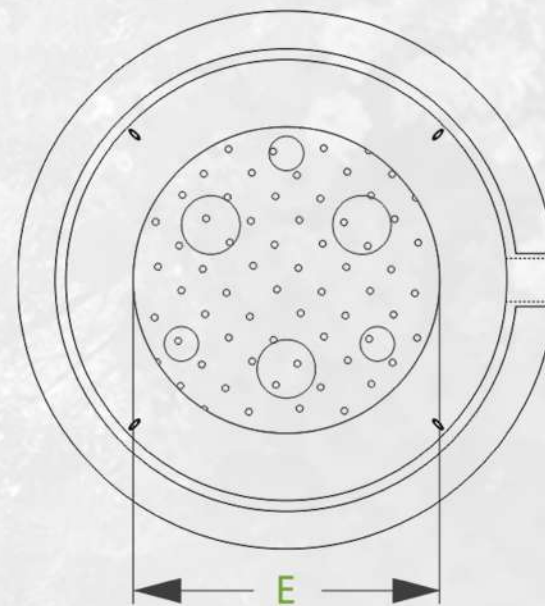

WIDOK Z GÓRY



WOVEN

MODEL

KOD

WYMIARY [MM]

CENA

WOVEN
z łańcuchem

AB WKR-0P

440mm x 280mm

360 zł



Gwarancja 10 lat

czarny

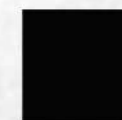

RAL 9005

ciemna zieleń



RAL 6032





Terra Group

Razem stworzymy
piękniejsze jutro!

ul. Gen. Józefa Sowińskiego 42a T: +48 68 455 62 69
65-419 Zielona Góra F.: +48 68 414 54 25

E: info@terra-pl.eu
www.terra-pl.eu