

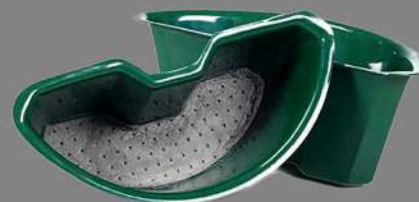

Wiszące Donice i kosze

samonawadniająca!

 **TerraFlor**
piękno czystej formy





BEST	2
BEST CUP	4
BARIST	6
BARIST BASE	8
CESAR	10
WOVEN	12

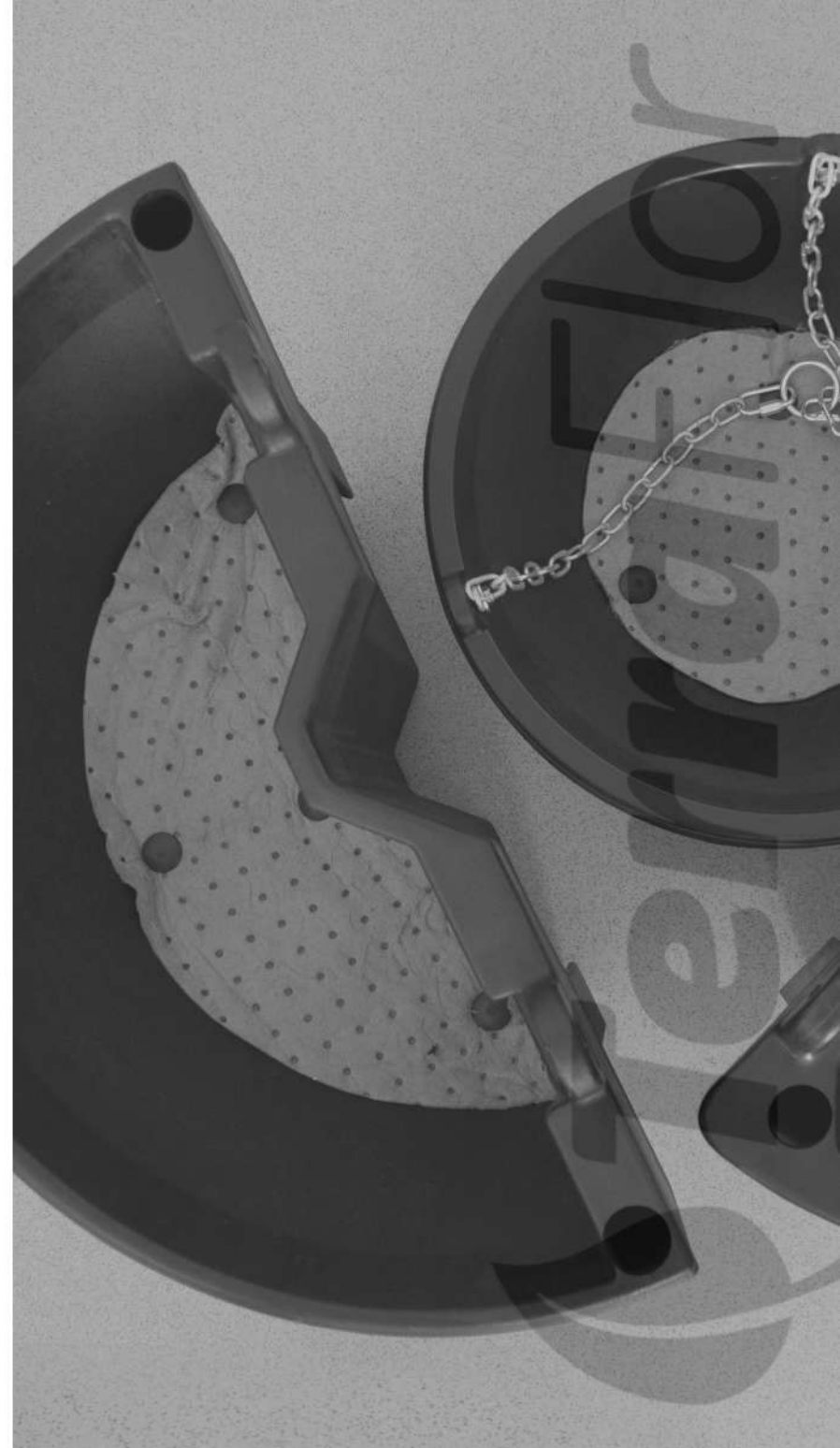

**BEST
590
800**



MODEL	KOD	WYMIARY [MM]	CENA
BEST 590 komplet (2 połówki + mocowanie)	AB UTP-1P	590mm x 270mm	720 zł
wkładka x 2			400 zł
BEST 800 komplet (2 połówki + mocowanie)	AB UTP-2P	800mm x 270mm	1100 zł
wkładka x 2			450 zł

czarny



RAL 9005

ciemna zieleń



RAL 6032



Gwarancja 10 lat

**BEST
590
800**

KARTA TECHNICZNA

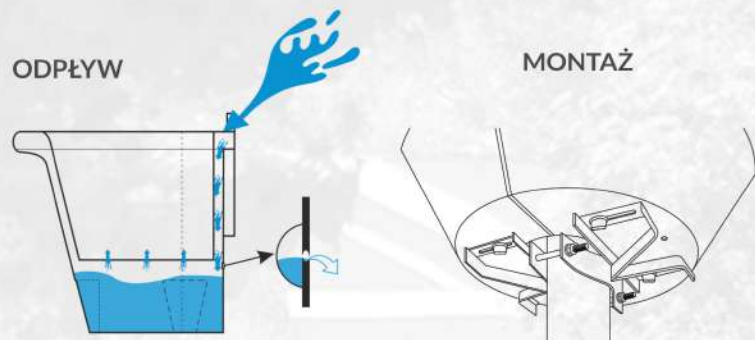

WIDOK Z PRZODU

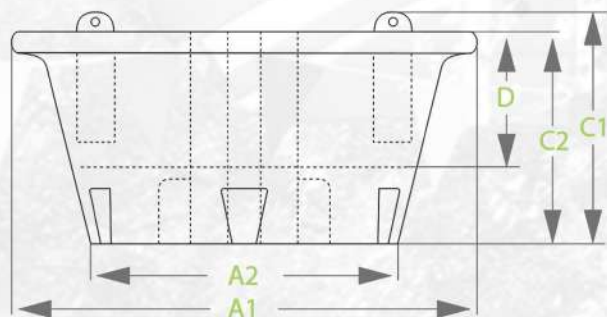

WIDOK Z BOKU

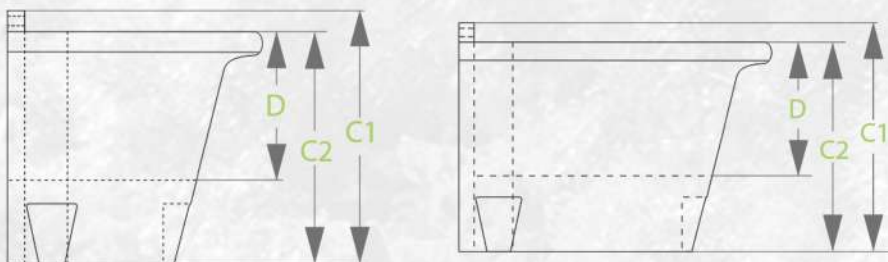

BEST 590

AB UTP-1P

A1	szerokość poziomu	590 mm		objętość substratu	▶ 12 l
A2	szerokość dolna	390 mm		zasobnik na wodę	▶ 5 l
B	głębokość poziomu	295 mm		waga przed obsadzeniem	▶ 2,2 kg
C1	wysokość całkowita	295 mm		waga po obsadzeniu	▶ 14 kg
C2	wysokość donicy	270 mm		szacunkowa ilość sadzonek	▶ 5-7 sztuk
D	głębokość wkładu	170 mm		waga uzależniona od rodzaju i wilgotności gleby.	
E	średnica spodu wkładu	410 mm			

BEST 800

AB UTP-2P

A1	szerokość poziomu	800 mm		objętość substratu	▶ 25 l
A2	szerokość dolna	600 mm		zasobnik na wodę	▶ 14 l
B	głębokość poziomu	400 mm		waga przed obsadzeniem	▶ 3,7 kg
C1	wysokość całkowita	295 mm		waga po obsadzeniu	▶ 31 kg
C2	wysokość donicy	270 mm		szacunkowa ilość sadzonek	▶ 10-12
D	głębokość wkładu	170 mm		waga uzależniona od rodzaju i wilgotności gleby.	
E	średnica spodu wkładu	630 mm			



Gwarancja na 10 lat

**BEST
CUP
650**



MODEL	KOD	WYMIARY [MM]	CENA
BEST CUP 650 komplet (2 połówki + mocowanie)	AB CNS-1P	650mm x 300mm	850 zł
wkładka x 2			400 zł

czarny



RAL 9005

ciemna zieleń



RAL 6032



Gwarancja 10 lat

**BEST
CUP
650**

KARTA TECHNICZNA

WIDOK Z PRZODU

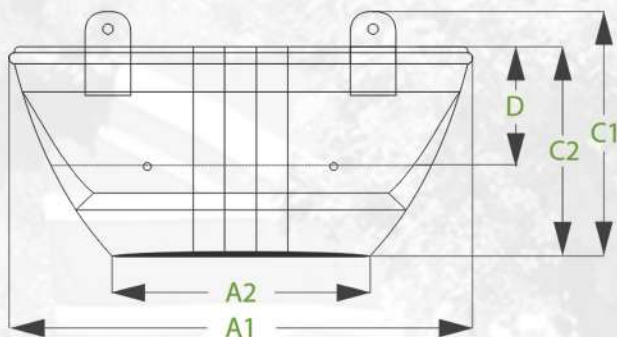

WIDOK Z GÓRY
POŁÓWKA

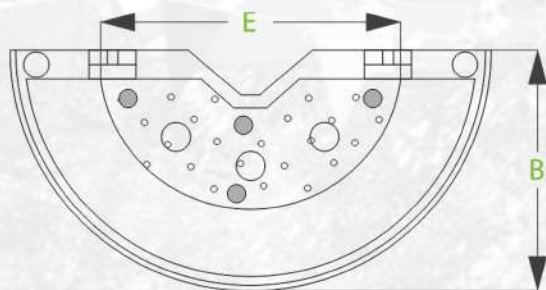

WIDOK Z BOKU

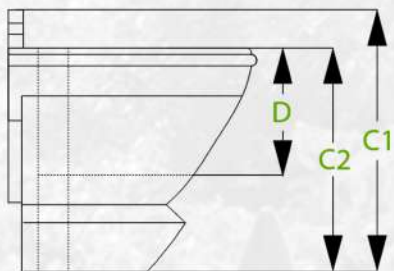

WIDOK Z GÓRY

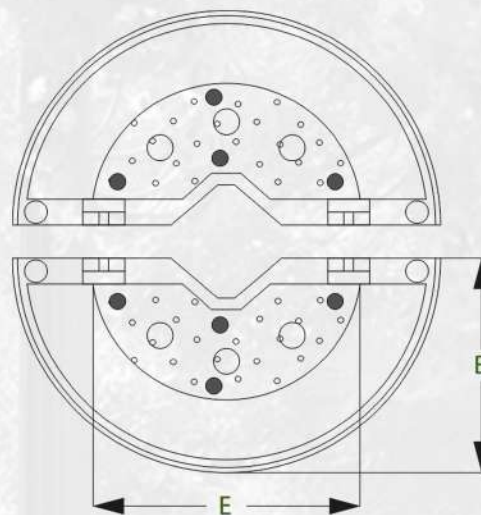

BEST CUP 650

AB CNS-1P

- | | | | | | |
|----|-----------------------|---------------|---|--|--|
| A1 | szerokość poziomu | 650 mm |  | objętość substratu | ▶ 12 litrów |
| A2 | szerokość dolna | 370 mm |  | zasobnik na wodę | ▶ 9 litry |
| B | głębokość poziomu | 325 mm |  | waga przed obsadzeniem | ▶ 2,7 kg |
| C1 | wysokość całkowita | 350 mm |  | waga po obsadzeniu | ▶ 18 kg  |
| C2 | wysokość donicy | 300 mm |  | szacunkowa ilość sadzonek | ▶ 5-7 sztuk |
| D | głębokość wkładu | 170 mm |  | waga uzależniona od rodzaju i wilgotności gleby. | |
| E | średnica spodu wkładu | 430 mm | | | |

MONTAŻ

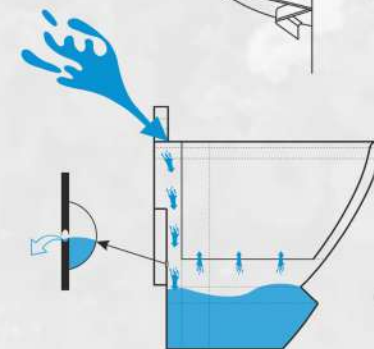
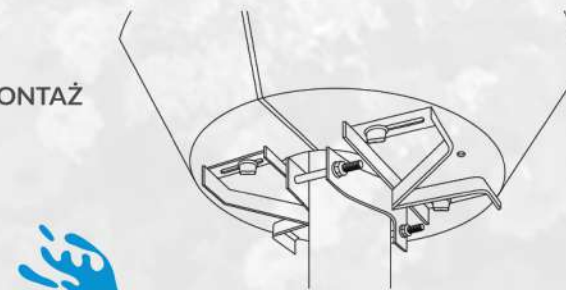

ODPŁYW

 Gwarancja na 10 lat



**BARIST
470**



MODEL	KOD	WYMIARY [MM]	CENA
BARIST 470 z łańcuchem	AB CHB-1P	470mm x 270mm	430 zł

czarny



RAL 9005

ciemna zieleń



RAL 6032



Gwarancja 10 lat

**BARIST
470**

KARTA TECHNICZNA

BARIST 470

AB CHB 1P

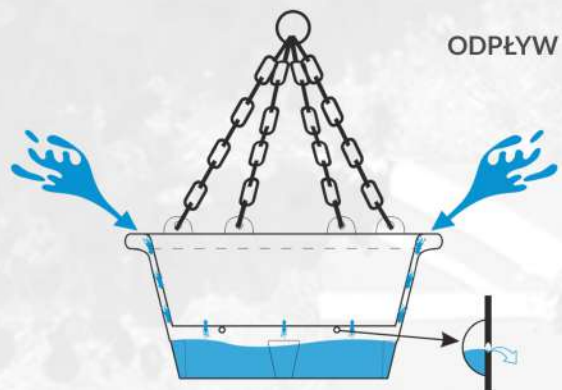



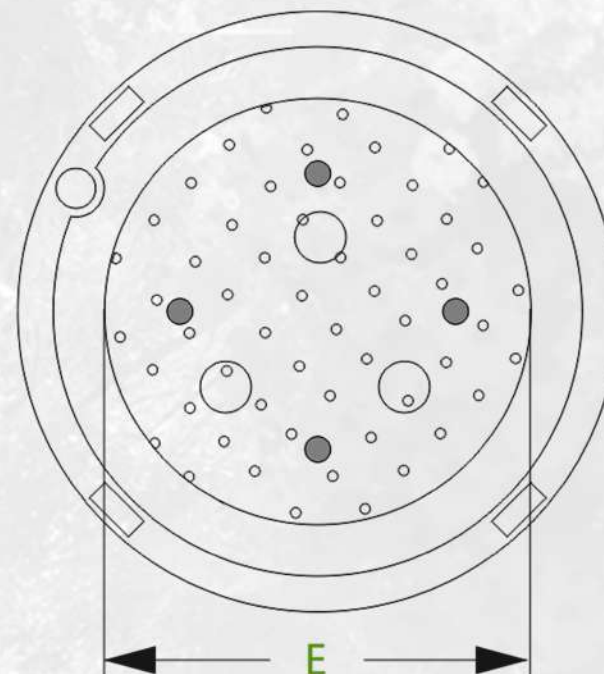



WIDOK Z PRZODU



WIDOK Z GÓRY

- A średnica poziomu **470 mm**
- B średnica dolna **285 mm**
- C wysokość całkowita **270 mm**
- D głębokość wkładu **190 mm**
- E średnica spodu wkładu **290 mm**

-  objętość substratu ► **24 litrów**
-  zasobnik na wodę ► **13 litry**
-  waga przed obsadzeniem ► **3,7 kg**
-  waga po obsadzeniu ► **27 kg** 
-  szacunkowa ilość sadzonek ► **12-15 sztuk**
-  waga uzależniona od rodzaju i wilgotności gleby.



BARIST

BASE

420

530



MODEL	KOD	WYMIARY [MM]	CENA
BARIST BASE 420 z łańcuchem	AB CAS-0P	420mm x 240mm	350 zł
BARIST BASE 530 z łańcuchem	AB CAS-1P	530mm x 265mm	630 zł

czarny



RAL 9005

ciemna zieleń



RAL 6032



Gwarancja 10 lat

BARIST BASE 420 530

KARTA TECHNICZNA

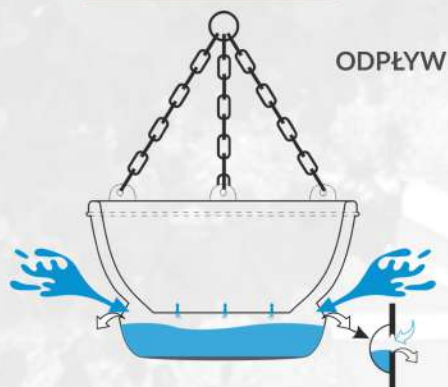

WIDOK Z PRZODU



WIDOK Z GÓRY

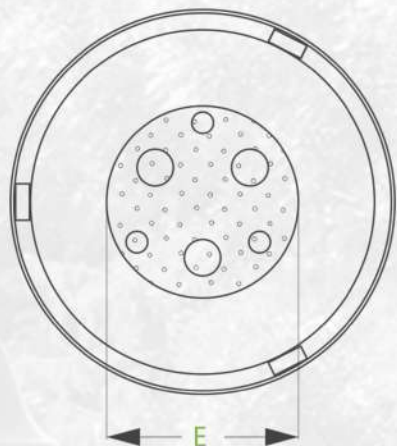

BARIST BASE 420

AB CAS-0P

- A średnica poziomu **420 mm**
- B średnica dolna **290 mm**
- C wysokość całkowita **240 mm**
- D głębokość wkładu **150 mm**
- E średnica spodu wkładu **210 mm**

- objętość substratu ► **11 litrów**
- zasobnik na wodę ► **7 litry**
- waga przed obsadzeniem ► **2,3 kg**
- waga po obsadzeniu ► **15 kg**
- szacunkowa ilość sadzonek ► **8-10 sztuk**
- waga uzależniona od rodzaju i wilgotności gleby.

BARIST BASE 530

AB CAS-1P

- A średnica poziomu **530 mm**
- B średnica dolna **320 mm**
- C wysokość całkowita **265 mm**
- D głębokość wkładu **190 mm**
- E średnica spodu wkładu **290 mm**

- objętość substratu ► **24 litrów**
- zasobnik na wodę ► **13 litry**
- waga przed obsadzeniem ► **3,7 kg**
- waga po obsadzeniu ► **27 kg**
- szacunkowa ilość sadzonek ► **12-15 sztuk**
- waga uzależniona od rodzaju i wilgotności gleby.



Gwarancja 10 lat

CESAR 500



MODEL	KOD	WYMIARY [MM]	CENA
CESAR 500 z łańcuchem	AB IMP-0P	500mm x 320mm	600 zł

czarny



RAL 9005

ciemna zieleń



RAL 6032



piaskowiec



Gwarancja 10 lat

T: +48 68 455 62 69 | E: INFO@TERRA-PL.EU | TERRA-PL.EU

TerraFlor

**CESAR
500**

KARTA TECHNICZNA

WOVEN 500



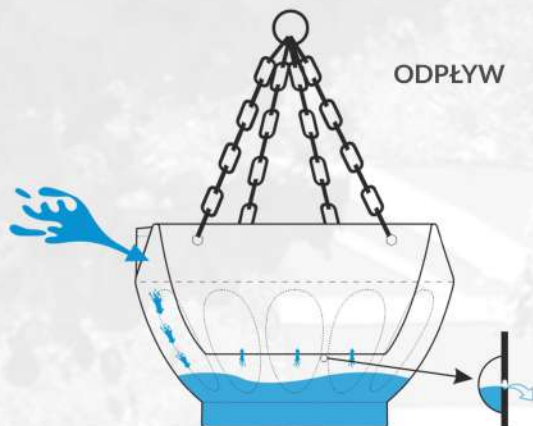

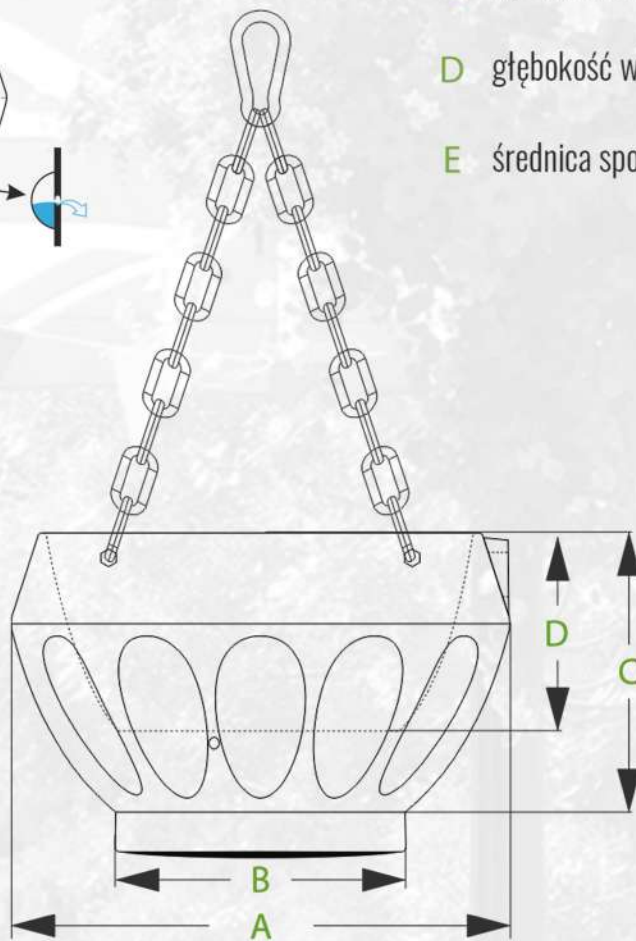

AB IMP-0P



WIDOK Z PRZODU



- A średnica poziomu **500 mm**
- B średnica dolna **290 mm**
- C wysokość całkowita **320 mm**
- D głębokość wkładu **195 mm**
- E średnica spodu wkładu **290 mm**

-  objętość substratu ▶ **20 litrów**
-  zasobnik na wodę ▶ **8 litry**
-  waga przed obsadzeniem ▶ **4,8 kg**
-  waga po obsadzeniu ▶ **22 kg** 
-  szacunkowa ilość sadzonek ▶ **10-12 sztuk**
-  waga uzależniona od rodzaju i wilgotności gleby.

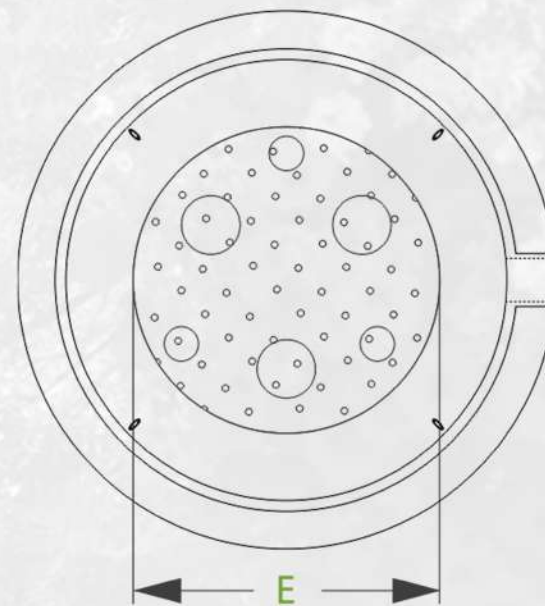

WIDOK Z GÓRY



**WOVEN
440**

MODEL	KOD	WYMIARY [MM]	CENA
WOVEN 440 z łańcuchem	AB WKR-0P	440mm x 280mm	360 zł



Gwarancja 10 lat

czarny

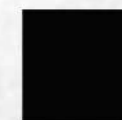

RAL 9005

ciemna zieleń



RAL 6032



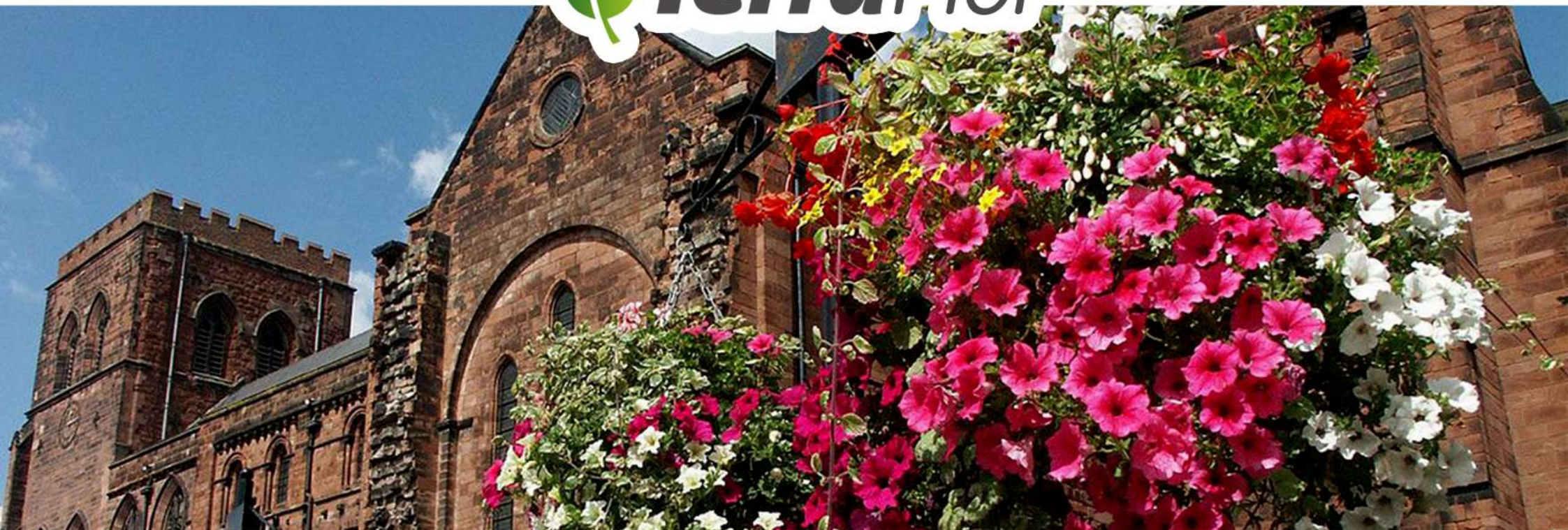

Terra Group

Razem stworzymy
piękniejsze jutro!

ul. Gen. Józefa Sowińskiego 42a T: +48 68 455 62 69
65-419 Zielona Góra F.: +48 68 414 54 25

E: info@terra-pl.eu
www.terra-pl.eu