



MADE IN ITALY

TeraPlast™

2 0 1 8



indice **PRODOTTI**
Index
Index
Verzeichnis



Linea Re

- 26 Re-Pots Hoop
- 30 Re-Pebbles

Intro Self Watering

- 34 Intro Self Watering

Linea Groove

- 40 Arena
- 46 Indy
- 50 Pixel
- 56 Ring
- 58 Urban

Linea Elements

- 64 Stem
- 66 Stalk
- 70 Stem luce/Stalk luce
- 72 Air
- 74 Hydral
- 82 Still
- 84 Aqua
- 86 Basilio
- 90 Kit balcone Hydral

Linea Clear

- 94 Orchidea
- 95 Plato Quadro
- 96 Porto/Plato
- 97 Madeira
- 98 Coimbra
- 99 Algarve

Linea Pastel

- 102 Madeira pastel
- 104 Estoril pastel
- 106 Santiago pastel

Linea Colour

- 110 Trio
- 112 Sunrise

- 114 Orchidea
- 116 Plato Quadro
- 118 Plato
- 120 Santiago
- 122 Estoril water reserve
- 124 Porto
- 128 Algarve
- 132 Madeira Luxy
- 134 Madeira
- 136 Coimbra

Linea Basic

- 140 Cilindro colour
- 143 Cilindro classic
- 144 Campana colour
- 145 Campana classic
- 146 Ciotola coste/Vaso coste
- 147 Ciotola con sottovaso
- 148 Sottovaso colour
- 149 Sottovaso classic
- 150 Quadro colour
- 151 Quadro classic
- 152 Cassettone colour
- 153 Cassettone classic
- 154 Sottovaso Quadro color/Sottovaso Quadro
- 155 Sottocassettone colour/Sottocassettone
- 156 Cassetta mare colour
- 159 Cassetta mare classic
- 160 Cassetta Cortina colour
- 161 Cassetta Cortina classic
- 162 Cassetta Tirol
- 163 Cassetta Portofino colour
- 164 Cassetta Portofino classic
- 166 Cassetta coste
- 167 kit balcone Coste/supporto Coste/supporto Mare
- 168 Sottocassetta colour
- 169 Sottocassetta classic

Display

- 170 Espositore Hydral
- 171 Espositore cilindri e sottovasi
- 172 Espositore cassette e sottocassette
- 173 Espositore cilindri/Espositore sottovasi
- 174 Marketingsupport

Balconiere

- 180 display kit balcone Mare 1 pz
- 181 display kit balcone Mare 2 pz

T-basket

- 184 T-Basket
- 186 T-Basket big

Linea Flortec

- 190 vaso Norma
- 192 vaso Container/vaso Crisa
- 193 vaso Basso/Gabbia verde

Linea Essential

- 196 Divio indoor/Corner indoor
- 200 Schio cassa
- 201 Schio sottocassa
- 202 Schio cubo
- 203 Schio sottocubo
- 204 Schio cubo basso
- 205 Schio cubo alto
- 208 Avila
- 210 Ribeira
- 212 Zamora
- 214 Leon
- 216 Standard One
- 218 quadro Veneto
- 219 cassa Veneto
- 220 jardinera Veneto
- 221 tondo Veneto
- 222 Schio cassa alta
- 223 Schio cono
- 224 Pasubio quadro
- 225 Pasubio cassa
- 226 Pasubio alto
- 228 Schio ciotola
- 229 Valentino/Bassano

Self Watering

- 233 Divio self watering
- 234 Schio cubo self watering
- 235 Schio cassa self watering

Linea Classic

- 238 Flora
- 239 cilindro Vicenza
- 240 cassetta liscia
- 241 quadro liscio
- 242 Africa/Tulipano
- 243 vaso festonato/vaso doppio bordo
- 244 campana Chiampo/cassetta Leonardo
- 245 cassetta millerighe/quadro millerighe
- 246 ciotola Castello/conca Classica
- 247 vaso Muro righe/vaso Muro liscio
- 248 sottovaso Muro/sottovaso Tondo
- 249 sottovaso Quadro/Sottocassetta

Linea City

- 252 New York
- 253 Venezia
- 254 Roma
- 255 A-Malo

Linea Luce

- 258 Standard one outdoor
- 259 Spritz
- 260 Africa outdoor
- 261 Tulipano outdoor
- 262 Valentino outdoor
- 263 Pasubio alto outdoor
- 264 Bassano outdoor
- 265 Schio cassa alta outdoor
- 266 Schio cubo alto outdoor
- 267 Schio cono outdoor
- 268 A-malo luce outdoor

Accessori

- 270 Mover
- 272 Fix ground round/Fix ground square
- 273 Fix Wall

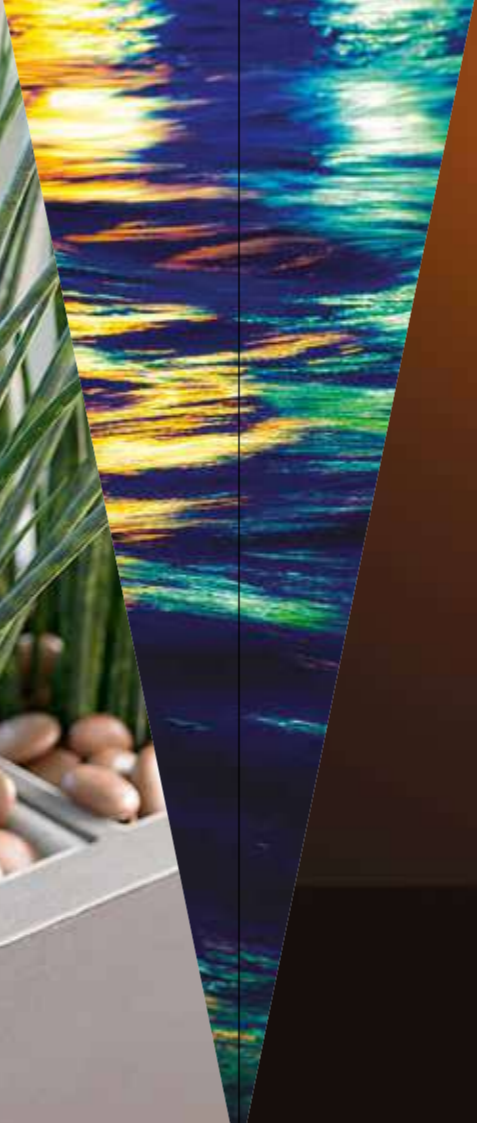

SELF WATERING



Divio



Schio Cubo



Schio Cassa

Essential Self Watering



Riserva d'acqua

La riserva d'acqua permette di alimentare le vostre piante senza bisogno di irrigarle spesso. I fori di drenaggio per il "troppo pieno" permettono di scaricare eventuali eccessi di acqua così sarà la pianta stessa ad attingere alla riserva d'acqua quando ne avrà bisogno.

Water reserve

The water reservoir allows to feed your plants without having to water it often. The drainage holes for the "overflow" allow you to download any excess water so the plant itself will be to draw on the reserve of water when it needs them. Some of the pots equipped with this system also have a coating membrane that, once removed, it allows excess water to leak from the pots.

Avec reserve de l'eau

Le réservoir d'eau permet de nourrir vos plantes sans avoir à les arroser souvent. Les trous de drainage pour le «débordement» vous permettent de télécharger tout excès d'eau de sorte que sera elle-même à puiser dans la réserve d'eau quand il en aura besoin. Certains des pots équipés de ce système ont également une membrane d'enrobage qui, une fois enlevé, permet à l'eau en excès de sortir.

Wasser reservoir

Das Wasser-Reservoir ermöglicht, Ihre Pflanzen zu versorgen, ohne ständig Wasser zuzuführen. Die Entwässerungslöcher lassen das Wasser überlaufen, damit die Pflanze das nach Bedarf schöpfen kann. Einige Pflanzgefäße mit Wasserspeicher besitzen eine Abdeckung-Membrane, die das Wasser, bei Wegnahme, überlaufen lässt.

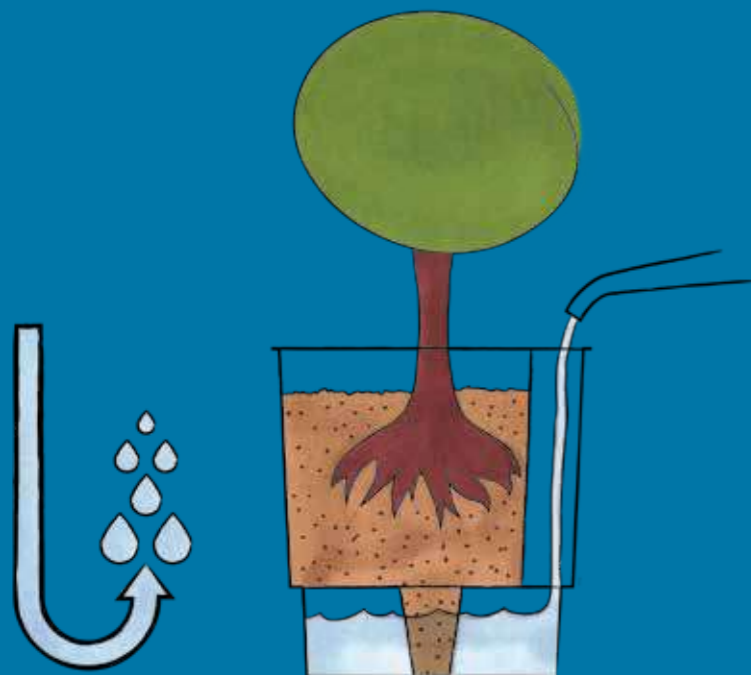

Evita l'annidamento di zanzare e altri insetti

It stops mosquitoes and other insects from laying eggs

Évite la nidation des moustiques et autres insectes

Das Einnisten von Mücken und anderen Insekten wird verhindert

Divio self watering



043
bianco/white
blanc/weiß



201
cappuccino/cappuccino
cappuccino/cappuccino



210
grafite/graphite
graphite/graphit



232
kiwi/kiwi
kiwi/Kiwi

colour on demand 030 050 211 202 068 203 208 230 233 234 204 049 204 039

codice senza colore code without colour	Cm	dimensioni esterne external dimensions	Confezione minima Minimum package	pezzi pallet pcs pallet
16 466 080	80	a90 b27 c77	1 91x28x79h	0,2 8 80x120x201h 1,93

diffusione dell'acqua per osmosi
water diffusion through osmosis's effect
diffusion de l'eau par osmose
Wasserdiffusion durch Osmose

riserva d'acqua
water reserve
réserve d'eau
Wasser-Reservoir

beccuccio per inserimento dell'acqua
spout for water insertion
bec pour l'introduction de l'eau
Füllschacht zur Wasserversorgung

griglia di drenaggio
drainage grid
gril pour le drainage
Bewässerungseinsatz



Schio cubo self watering



043 bianco/white
blanc/weiß

201 cappuccino/cappuccino
cappuccino/cappuccino

032 antracite/anthracite
anthracite/anthrazitgrau

050 rosso cardinale/cardinal red
rouge cardinal/scharlachrot

039 bronzino/bronze
bronze/bronze

codice senza colore code without colour	Cm	dimensioni esterne external dimensions	Confezione minima Minimum package	m ³	pezzi pallet pcs pallet	m ³
16 425 030	30	a:30 b:30 c:28	1 30x30x30h	0,02	24	80x120x115h 1,10

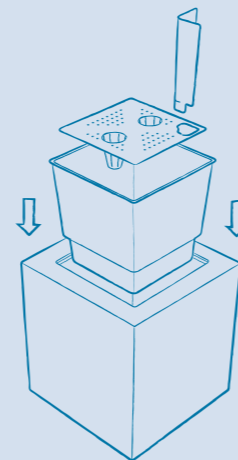
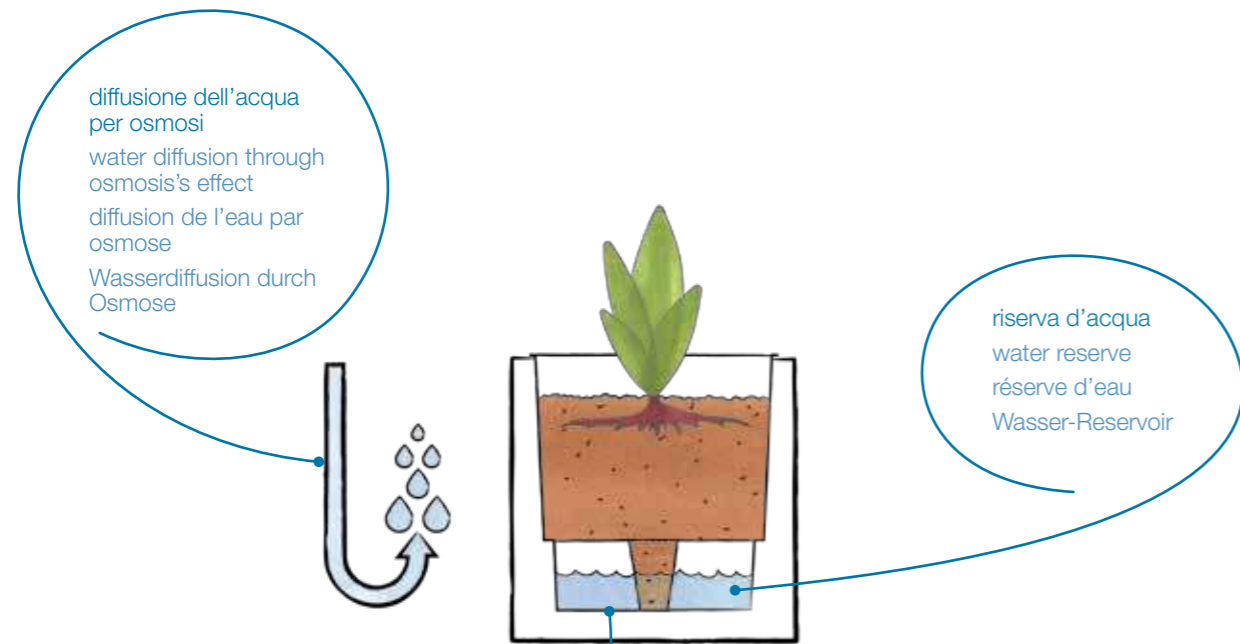

Schio cassa self watering



043 bianco/white
blanc/weiß

201 cappuccino/cappuccino
cappuccino/cappuccino

032 antracite/anthracite
anthracite/anthrazitgrau

050 rosso cardinale/cardinal red
rouge cardinal/scharlachrot

039 bronzino/bronze
bronze/bronze

codice senza colore code without colour	Cm	dimensioni esterne external dimensions	Confezione minima Minimum package	m ³	pezzi pallet pcs pallet	m ³
16 427 080	80	a:80 b:30 c:30	2 80x30x30h	0,07	28	80x120x222h 2,13

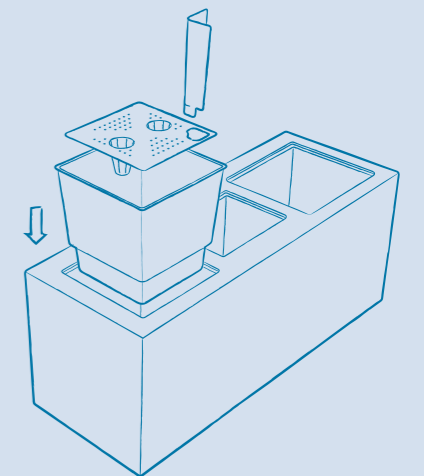
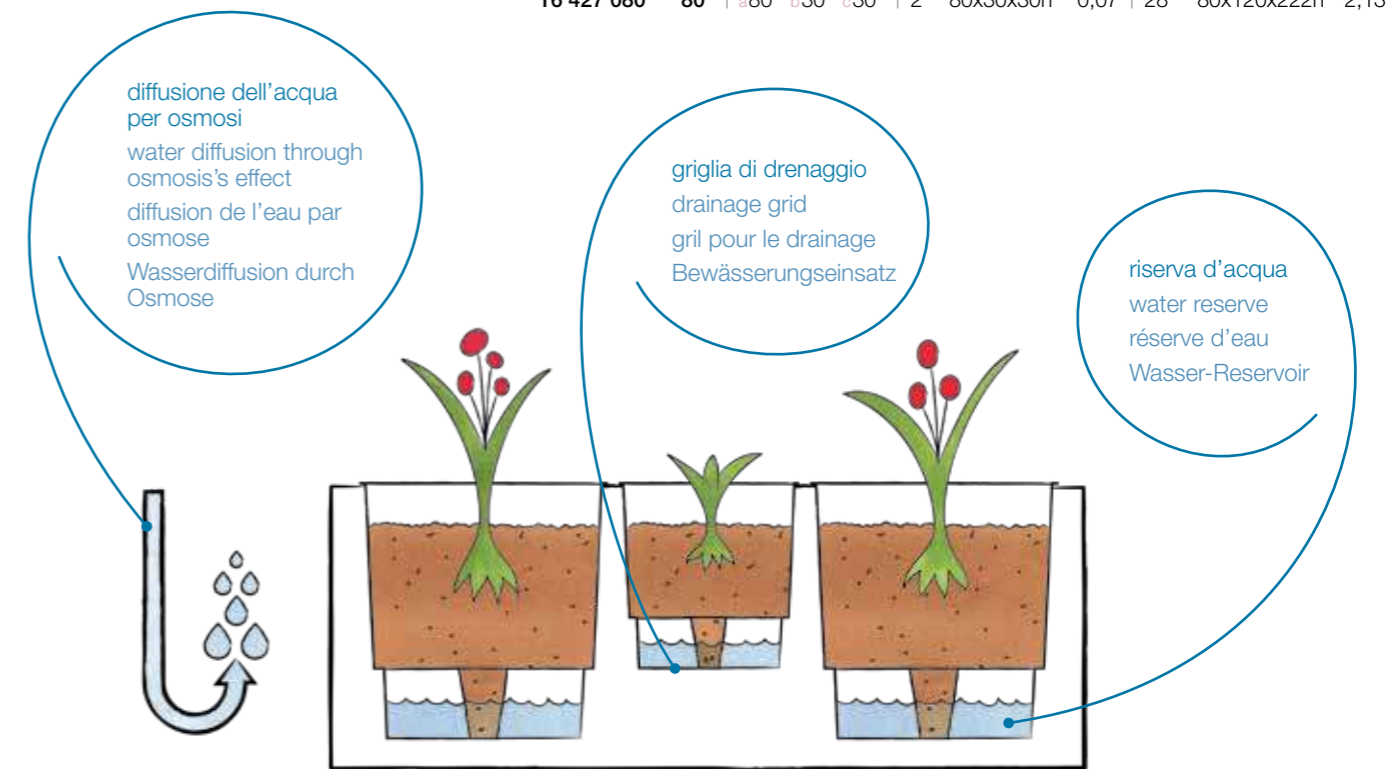

Legenda

Legenda

Légende

Legende



Superficie lucida
Glossy surface
Surface brillante
Glänzende Oberfläche

I vasi con la superficie lucida sono allegri e colorati. Si adattano facilmente al contesto creando un ambiente fresco e vivace.

Pots with glossy surface are jolly and bright. They be easily fit to the context, making the background fresh and vivid.

Les vases avec la surface brillante sont gais et colorés. Ils s'adaptent au contexte aisément en créant un milieu frais et vif.

Pflanzgefäße mit glänzender Oberfläche sind heiter und farbig. Sie richten sich nach dem Kontext und machen die Atmosphäre frisch und lebhaft.



Superficie opaca
Matt finished
Surface opaque
Matt-Oberfläche

I vasi con la superficie opaca sono eleganti e raffinati. Si prestano ad arredare i tuoi spazi con gusto e armonia.

Pots with matt surface are elegant and refined. They are fit to furnish your space with taste and harmony.

Les vases avec la surface opaque sont élégants et raffinés. Ils se prêtent à meubler vos espaces avec goût et harmonie.

Pflanzgefäße mit matter Oberfläche sind elegant und verfeinert. Ideal um Ihren Raum durch Geschmack und Harmonie auszustatten.

 sottovaso / saucer
soucoupes / untersetzer

 sacchetto / bag
sachets /beutel

 sfuso / loose pieces
en vrac / lose Stk

 display pallet

 pallet di scatole
pallet of carton boxes

 scatola / box
carton / karton

 pallet

 fix ground

 fix wall

 supporto Cassetta Coste
Iron support for Cassetta Coste
Support pour jardinière Coste
Träger für die Cassetta Coste

 supporto Cassetta Mare
Iron support for Cassetta Mare
Support pour Cassetta Mare
Träger für die Cassetta Mare

 Self Watering
SELF WATERING

La riserva d'acqua permette di alimentare le vostre piante senza bisogno di irrigarle spesso.
Water system allows to feed plants without needing to irrigate it often.
La réserve d'eau permet d'alimenter vos plantes sans besoin de leur irriguer souvent.
Das Wasser-Reservoir ermöglicht es, die Pflanzen zu versorgen, ohne oft zu begießen.

 Evita l'annidamento di zanzare e altri insetti.
It stops mosquitoes and other insects from laying eggs.
Évite la nidation des moustiques et autres insectes.
Das Einnisten von Mücken und anderen Insekten wird verhindert.

 Leggerissimo
Very light
Très léger
Sehr Leicht

 Inalterabile nel colore
Colourfast dyes
Inalterabilité des couleurs
Farbbeständig
U.V. RESISTANT

 Resistente al caldo e al freddo
Warm and cold resistant
Résistant à la chaleur et au froid
Wetterfest
-30 +60

 Sottovaso incluso
Saucer included
Soucoupe intégrée
Integrierter unterstzer

 Resistente agli urti
Shock resistant
Résistant aux chocs
Stoß und Bruchfest

 Ecologico: atossico e riciclabile
Ecological: non-toxic and recyclable
Ecologique: recyclable et not toxique
Umweltfreundlich: nicht toxisch und recyclingfähig
RECYCLABLE

Siamo molto orgogliosi del nostro impianto fotovoltaico da 1,17 MW, posizionato sui tetti dei reparti produttivi e del magazzino, con il quale produciamo energia pulita per poter produrre i nostri vasi. Questa scelta, insieme all'utilizzo di materie prime riciclate di alta qualità e a politiche atte ad evitare sprechi in fase di imballaggio, rende Teraplast uno dei produttori di vasi più sostenibile.

We are very proud of our photovoltaic installation of 1,17 MW, placed on the roof of our production and warehouse, wherewith we produce clean energy to produce our pots. This choice, together with the use of high quality recycled raw material and strict policies to avoid wastes in the packaging process, emphasizes Teraplast as one of the most environmental friendly company.

Nous sommes très fiers de notre installation photovoltaïque de 1,17 MW, positionné sur les toits des rayons productifs et du magasin avec laquelle nous produisons énergie propre pour pouvoir produire nos vases. Avec le choix d'utiliser des matières premières recyclées de haute qualité en contribuant à la politique d'antigaspiages en phase d'emballage, Teraplast devient un des producteurs de vases les plus respectables.

Wir sind sehr stolz auf unsere Photovoltaikanlage mit 1,17 MW, auf dem Werk- und Lagerdach, womit wir saubere Energie erzeugen, um unsere Töpfe herzustellen. Diese Entscheidung, zusammen mit der Verwendung von recycelt hochwertigen Rohstoffe und ohne Verschwendungen in der Verpackungsphase, macht TeraPlast einer der am nachhaltigsten Hersteller von Pflanzgefäße.

 Con lampadina
Illuminated
Lumineux
Mit licht

 Facilente lavabile senza detersivi
Easy to wash without detergents
Très facile à entretenir
Einfach ohne Reinigungsmittel waschbar

 Impilabile
Stackable
Impilables
Stapelbar

Per agevolare il trasporto e la vendita a scaffale molti dei nostri vasi sono impilabili.
A wide range of our pots are stockable in order to ensure easy transportation and friendly merchandising.
Pour faciliter le transport et la vente en étagères beaucoup de nos vases sont impilables.
Unsere Pflanzgefäße sind stapelbar, um den Transport und den Verkauf auf Regale zu erleichtern.

 Foro predisposto
Can be drilled to drainage
Trous de drainage prévus
Loch Vorsatz

I vasi con il foro predisposto possono essere facilmente forabili per permettere il drenaggio dell'acqua. Una volta effettuata questa operazione si consiglia l'abbinamento con il sottovaso adeguato.
Pre drilled pots can be easily drilled to allow the drain of the water. Once done this operation we recommend to combine them with the suitable saucer.

Les vases qui ont le trou prépercé peuvent favoriser le drainage de l'eau. Une fois cette opération effectuée veuillez demander conseil au distributeur afin de trouvé le dessous de pot correspondant.

Pflanzgefäße mit vorgesehenem Loch sind einfach durchzulöchern für den Wasserdränage. Nach dem Durchlöchern ist die Benutzung des anpassenden Untersetzers zu empfehlen.

Colori on Demand

Colours on Demand

Farben auf Anfrage

Couleurs sur Demande



237	bianco / white blanc / weiß
238	nero / black noir / schwarz
239	verde / green vert / grün
240	mairone / brown marron / braun
241	grigio / grey grise / grauer
024	trasparente / transparent transparent / transparent
022	bianco / white blanc / weiß
012	argento / silver argenté / silbrig
008	sabbia / sand colour sable / sand
013	giallo / yellow jaune / gelb
419	giallo / yellow jaune / gelb
011	oro / gold dore / gold
010	rosso / red rouge / rot
014	rosso intenso / intense red rouge intense / starkes rot
416	marsala / marsala marsala / marsala
020	bronzo / bronze bronce / bronze
018	ciclaminio / cyclamen cyclamen / zyklamienfarbe
401	peonia / peony pivoine / pfingstrose
019	lilla / lilac lilas / lilas
402	lilyum / lilyum lilyum / lilyum
009	viola / violet violet / veilchenblau
405	bambù / bamboo bambou / bambus
404	cedro / cedar cedre / zeder
007	verde / green vert / grün
407	salvia / sage sauge / salbei
002	verde / green vert / grün
028	turchese / turquoise turquoise / türkis
015	azzurro / light blue azur / hellblau
017	blu / blue bleu / dunkelblau
403	corda / cord corde / seil
417	aluminium / aluminium aluminium / aluminium
406	bruno / brown brun / braun
415	terra di Siena / terra di siena terra di siena / terra di siena
408	cacao / cocoa cacao / kakao
001	terraccotta / terracotta colour couleur terre / farbe terrakotta

414	fog grey / fog grey brouillard gris / Nebel grau
005	antracite / anthracite anthracite / anthrazitgrau
006	nero / black noir / schwarz
003	nero / black noir / schwarz
412	acqua marina / aquamarine ague-marine / aquamarin
410	ghiaccio / ice glace / eis
409	malva / mauve mauve / mauve
411	porcellana / porcelain porcelaine / porzellan
043	bianco / white blanc / weiß
033	bianco neutro / neutral white blanc neutre / neutrales weiß
071	bianco lucido / gloss white blanc brillant / weiß glänzend
034	arancio / orange orange / orange
030	anticato / light brown marron clair / hellbraun
048	rosso / red rouge / rot
050	rosso cardinale / cardinal red rouge cardinal / scharlachrot
070	rosso lucido / gloss red rouge brillant / leuchtendrot
042	fucsia / fuchsia fuchsia / fuchsiafarbig
231	fucsia / fuchsia fuchsia / fuchsiafarbig
068	fucsia / fuchsia fuchsia / fuchsiafarbig
211	melanzana / aubergine aubergine / aubergine
234	malva / mauve mauve / mauve
202	lavanda / lavender lavande / lavendel
203	lime / lime citron vert / limonelle
232	kiwi / kiwi kiwi / kiwi
208	menta / mint menthe / Minze
041	verde mela / green apple vert pomme / apfelgrün
230	cielo / sky blue ciel bleu / blauer Himmel
204	grigio seta / silk grey grise soie / grauer Seide
201	capuccino / cappuccino cappuccino / cappuccino
233	toffee / toffee caramel / toffee
049	grigio fumo / smoke grey gris fumé / rauchgrau
039	bronzo / bronze bronce / bronze
210	grafite / graphite graphite / graphit
235	beton / beton beton / beton
032	antracite / anthracite anthracite / anthrazitgrau
037	nero / black noir / schwarz
072	nero lucido / gloss black noir brillant / glänzend schwarz

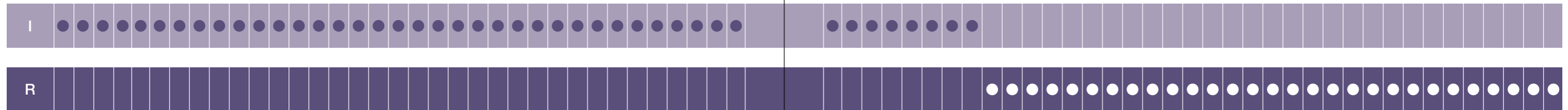

INIEZIONE

- Linea Re
- Linea Elements
- Linea Clear
- Linea Pastel
- Linea Colour
- Linea Basic
- T-basket
- Linea Flortec

ROTAZIONALE

- Linea Groove
- Linea Essential
- Self Watering
- Linea Classic
- Linea City
- Linea Luce

Colori on Demand
da concordare con la rete vendita
minimi d'ordine e quantità.

Colours on Demand to be agreed
with the Sales network, minimum
order quantity and prices.

Farben auf Anfrage. Mindestbe-
stellmenge und Preise müssen mit
den Vertretern vereinbart werden.

Couleurs sur demande à définir
avec le réseau commercial, mini-
mum commande et prix.

Progetto grafico ed impaginazione:

Verde Pistacchio - info@verdepistacchio.net

Le ambientazioni:

Alexis visual arts - Via Giovanni Dolfin, 8 - 36016 Thiene (VI) - www.alexisvisual.com per pag. 41.

Verde Architettura - via Fumagalli, 7 - 20143 (MI) - www.verdearchitettura.it per pag. 218.

Anymotion - Corso Garibaldi, 81 - 29017 Fiorenzuola D'Arda (PC) pag. 214, 215, 216, 219.

Foto:

Photopiù - Via Rivarotta, 165 - 36061 Bassano del Grappa (VI) - www.photopiu.it

BitCreativo di Mazzaro Elia - Via Col di Lana, 10 - 36034 Malo (VI) - www.bitcreativo.it

Designer:

favarettoandpartner di pag. 40.

Irina Alekseeva di pag. 206, 207, 208.

Dati, foto e caratteristiche non sono impegnativi; Teraplast si riserva di apportare le modifiche che riterrà opportune per migliorare i suoi prodotti.

Tutte le parti di questo catalogo - foto comprese - sono di proprietà di Teraplast. La riproduzione, anche parziale, è vietata in ogni forma e con ogni mezzo.

Data, photos, and characteristics are not binding; Teraplast reserves the right to produce modifications considered necessary to improve its products.

Every part of this catalogue - photos included - is the property of Teraplast. All forms of copying are strictly prohibited.

TeraPlast™ S.p.a.

Via del Progresso, 65 (GPS: Località Conca)
36070 Castelgomberto (VI) - ITALY
tel. +39 0445 444 100 - fax +39 0445 444 111
www.teraplast.com - info@teraplast.com