



MADE IN ITALY

TeraPlast™

2 0 1 8



indice **PRODOTTI**
Index
Index
Verzeichnis



Linea Re

- 26 Re-Pots Hoop
- 30 Re-Pebbles

Intro Self Watering

- 34 Intro Self Watering

Linea Groove

- 40 Arena
- 46 Indy
- 50 Pixel
- 56 Ring
- 58 Urban

Linea Elements

- 64 Stem
- 66 Stalk
- 70 Stem luce/Stalk luce
- 72 Air
- 74 Hydral
- 82 Still
- 84 Aqua
- 86 Basilio
- 90 Kit balcone Hydral

Linea Clear

- 94 Orchidea
- 95 Plato Quadro
- 96 Porto/Plato
- 97 Madeira
- 98 Coimbra
- 99 Algarve

Linea Pastel

- 102 Madeira pastel
- 104 Estoril pastel
- 106 Santiago pastel

Linea Colour

- 110 Trio
- 112 Sunrise

- 114 Orchidea
- 116 Plato Quadro
- 118 Plato
- 120 Santiago
- 122 Estoril water reserve
- 124 Porto
- 128 Algarve
- 132 Madeira Luxy
- 134 Madeira
- 136 Coimbra

Linea Basic

- 140 Cilindro colour
- 143 Cilindro classic
- 144 Campana colour
- 145 Campana classic
- 146 Ciotola coste/Vaso coste
- 147 Ciotola con sottovaso
- 148 Sottovaso colour
- 149 Sottovaso classic
- 150 Quadro colour
- 151 Quadro classic
- 152 Cassettone colour
- 153 Cassettone classic
- 154 Sottovaso Quadro color/Sottovaso Quadro
- 155 Sottocassettone colour/Sottocassettone
- 156 Cassetta mare colour
- 159 Cassetta mare classic
- 160 Cassetta Cortina colour
- 161 Cassetta Cortina classic
- 162 Cassetta Tirol
- 163 Cassetta Portofino colour
- 164 Cassetta Portofino classic
- 166 Cassetta coste
- 167 kit balcone Coste/supporto Coste/supporto Mare
- 168 Sottocassetta colour
- 169 Sottocassetta classic

Display

- 170 Espositore Hydral
- 171 Espositore cilindri e sottovasi
- 172 Espositore cassette e sottocassette
- 173 Espositore cilindri/Espositore sottovasi
- 174 Marketingsupport

Balconiere

- 180 display kit balcone Mare 1 pz
- 181 display kit balcone Mare 2 pz

T-basket

- 184 T-Basket
- 186 T-Basket big

Linea Flortec

- 190 vaso Norma
- 192 vaso Container/vaso Crisa
- 193 vaso Basso/Gabbia verde

Linea Essential

- 196 Divio indoor/Corner indoor
- 200 Schio cassa
- 201 Schio sottocassa
- 202 Schio cubo
- 203 Schio sottocubo
- 204 Schio cubo basso
- 205 Schio cubo alto
- 208 Avila
- 210 Ribeira
- 212 Zamora
- 214 Leon
- 216 Standard One
- 218 quadro Veneto
- 219 cassa Veneto
- 220 jardinera Veneto
- 221 tondo Veneto
- 222 Schio cassa alta
- 223 Schio cono
- 224 Pasubio quadro
- 225 Pasubio cassa
- 226 Pasubio alto
- 228 Schio ciotola
- 229 Valentino/Bassano

Self Watering

- 233 Divio self watering
- 234 Schio cubo self watering
- 235 Schio cassa self watering

Linea Classic

- 238 Flora
- 239 cilindro Vicenza
- 240 cassetta liscia
- 241 quadro liscio
- 242 Africa/Tulipano
- 243 vaso festonato/vaso doppio bordo
- 244 campana Chiampo/cassetta Leonardo
- 245 cassetta millerighe/quadro millerighe
- 246 ciotola Castello/conca Classica
- 247 vaso Muro righe/vaso Muro liscio
- 248 sottovaso Muro/sottovaso Tondo
- 249 sottovaso Quadro/Sottocassetta

Linea City

- 252 New York
- 253 Venezia
- 254 Roma
- 255 A-Malo

Linea Luce

- 258 Standard one outdoor
- 259 Spritz
- 260 Africa outdoor
- 261 Tulipano outdoor
- 262 Valentino outdoor
- 263 Pasubio alto outdoor
- 264 Bassano outdoor
- 265 Schio cassa alta outdoor
- 266 Schio cubo alto outdoor
- 267 Schio cono outdoor
- 268 A-malo luce outdoor

Accessori

- 270 Mover
- 272 Fix ground round/Fix ground square
- 273 Fix Wall

Legenda

Legenda

Légende

Legende



Superficie lucida
Glossy surface
Surface brillante
Glänzende Oberfläche

I vasi con la superficie lucida sono allegri e colorati. Si adattano facilmente al contesto creando un ambiente fresco e vivace.

Pots with glossy surface are jolly and bright. They be easily fit to the context, making the background fresh and vivid.

Les vases avec la surface brillante sont gais et colorés. Ils s'adaptent au contexte aisément en créant un milieu frais et vif.

Pflanzgefäße mit glänzender Oberfläche sind heiter und farbig. Sie richten sich nach dem Kontext und machen die Atmosphäre frisch und lebhaft.



Superficie opaca
Matt finished
Surface opaque
Matt-Oberfläche

I vasi con la superficie opaca sono eleganti e raffinati. Si prestano ad arredare i tuoi spazi con gusto e armonia.

Pots with matt surface are elegant and refined. They are fit to furnish your space with taste and harmony.

Les vases avec la surface opaque sont élégants et raffinés. Ils se prêtent à meubler vos espaces avec goût et harmonie.

Pflanzgefäße mit matter Oberfläche sind elegant und verfeinert. Ideal um Ihren Raum durch Geschmack und Harmonie auszustatten.

 sottovaso / saucer
soucoupes / untersetzer

 sacchetto / bag
sachets /beutel

 sfuso / loose pieces
en vrac / lose Stk

 display pallet

 pallet di scatole
pallet of carton boxes

 scatola / box
carton / karton

 pallet

 fix ground

 fix wall

 supporto Cassetta Coste
Iron support for Cassetta Coste
Support pour jardinière Coste
Träger für die Cassetta Coste

 supporto Cassetta Mare
Iron support for Cassetta Mare
Support pour Cassetta Mare
Träger für die Cassetta Mare

 Self Watering
SELF WATERING

La riserva d'acqua permette di alimentare le vostre piante senza bisogno di irrigarle spesso.
Water system allows to feed plants without needing to irrigate it often.
La réserve d'eau permet d'alimenter vos plantes sans besoin de leur irriguer souvent.
Das Wasser-Reservoir ermöglicht es, die Pflanzen zu versorgen, ohne oft zu begießen.

 Evita l'annidamento di zanzare e altri insetti.
It stops mosquitoes and other insects from laying eggs.
Évite la nidation des moustiques et autres insectes.
Das Einnisten von Mücken und anderen Insekten wird verhindert.

 Leggerissimo
Very light
Très léger
Sehr Leicht

 Inalterabile nel colore
Colourfast dyes
Inalterabilité des couleurs
Farbbeständig
U.V. RESISTANT

 Resistente al caldo e al freddo
Warm and cold resistant
Résistant à la chaleur et au froid
Wetterfest
-30 +60

 Sottovaso incluso
Saucer included
Soucoupe intégrée
Integrierter unterstzer

 Resistente agli urti
Shock resistant
Résistant aux chocs
Stoß und Bruchfest

 Ecologico: atossico e riciclabile
Ecological: non-toxic and recyclable
Ecologique: recyclable et not toxique
Umweltfreundlich: nicht toxisch und recyclingfähig
RECYCLABLE

Siamo molto orgogliosi del nostro impianto fotovoltaico da 1,17 MW, posizionato sui tetti dei reparti produttivi e del magazzino, con il quale produciamo energia pulita per poter produrre i nostri vasi. Questa scelta, insieme all'utilizzo di materie prime riciclate di alta qualità e a politiche atte ad evitare sprechi in fase di imballaggio, rende Teraplast uno dei produttori di vasi più sostenibile.

We are very proud of our photovoltaic installation of 1,17 MW, placed on the roof of our production and warehouse, wherewith we produce clean energy to produce our pots. This choice, together with the use of high quality recycled raw material and strict policies to avoid wastes in the packaging process, emphasizes Teraplast as one of the most environmental friendly company.

Nous sommes très fiers de notre installation photovoltaïque de 1,17 MW, positionné sur les toits des rayons productifs et du magasin avec laquelle nous produisons énergie propre pour pouvoir produire nos vases. Avec le choix d'utiliser des matières premières recyclées de haute qualité en contribuant à la politique d'antigaspiages en phase d'emballage, Teraplast devient un des producteurs de vases les plus respectables.

Wir sind sehr stolz auf unsere Photovoltaikanlage mit 1,17 MW, auf dem Werk- und Lagerdach, womit wir saubere Energie erzeugen, um unsere Töpfe herzustellen. Diese Entscheidung, zusammen mit der Verwendung von recycelt hochwertigen Rohstoffe und ohne Verschwendungen in der Verpackungsphase, macht TeraPlast einer der am nachhaltigsten Hersteller von Pflanzgefäße.

 Con lampadina
Illuminated
Lumineux
Mit licht

 Facilente lavabile senza detersivi
Easy to wash without detergents
Très facile à entretenir
Einfach ohne Reinigungsmittel waschbar

 Impilabile
Stackable
Impilables
Stapelbar

Per agevolare il trasporto e la vendita a scaffale molti dei nostri vasi sono impilabili.

A wide range of our pots are stockable in order to ensure easy transportation and friendly merchandising.

Pour faciliter le transport et la vente en étagères beaucoup de nos vases sont impilables.

Unsere Pflanzgefäße sind stapelbar, um den Transport und den Verkauf auf Regale zu erleichtern.

 Foro predisposto
Can be drilled to drainage
Trous de drainage prévus
Loch Vorsatz

I vasi con il foro predisposto possono essere facilmente forabili per permettere il drenaggio dell'acqua. Una volta effettuata questa operazione si consiglia l'abbinamento con il sottovaso adeguato.

Pre drilled pots can be easily drilled to allow the drain of the water. Once done this operation we recommend to combine them with the suitable saucer.

Les vases qui ont le trou prépercé peuvent favoriser le drainage de l'eau. Une fois cette opération effectuée veuillez demander conseil au distributeur afin de trouvé le dessous de pot correspondant.

Pflanzgefäße mit vorgesehenem Loch sind einfach durchzulöchern für den Wasserdränage. Nach dem Durchlöchern ist die Benutzung des anpassenden Untersetzers zu empfehlen.

MADE IN ITALY

TeraPlast™



*100%
Recycled and
Recyclable
Plastic Products*



linea
RE

RESPECT
INSIDE™



NEWS
2018

LINEA *Re*

RE-POTS™ HOOP

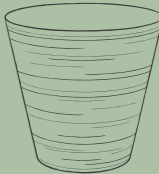

RE-PEBBLES™



PASSIONE PER LA SPERIMENTAZIONE

Teraplast è una nuova realtà nel panorama dei vasi in plastica e si distingue per flessibilità, innovazione e gamma di prodotti. Produciamo articoli con tecnologia ad iniezione e rotazionale riuscendo a soddisfare le esigenze di settori diversificati. Inoltre possiamo realizzare, a richiesta, tutti gli articoli in una ampia gamma di colori.

Siamo in grado di soddisfare le necessità della clientela più esigente fornendo servizi personalizzati come la progettazione e la realizzazione degli stampi, la lavorazione di materiali diversi, l'assemblaggio finale di più particolari e la realizzazione di imballi su misura.

Con la sua propensione all'innovazione, Teraplast è orientata alla sperimentazione e alla ricerca al di là dei limiti dei materiali, delle tecnologie e delle forme, per arrivare a creare prodotti innovativi, fonti di ispirazione e di piacere alla vista.

Grazie ai suoi prodotti Teraplast continua la tradizione di eccellenza che da sempre è associata al marchio Made in Italy, riuscendo a coniugare la funzionalità del vaso alla dimensione estetica.

L'ampliamento della gamma con l'introduzione di arredi per esterni è stata la diretta conseguenza della filosofia aziendale, ed ha portato alla creazione di sedute, tavoli e lampade, reinventati per dare ad ambienti esterni la stessa ricercatezza di quelli interni.

Che si tratti di un vaso, di un tavolo geometrico o di un oggetto di design i prodotti Teraplast catturano l'attenzione e sono concepiti per essere sia funzionali che affascinanti, attestando l'eccellente capacità di lavorazione nel campo delle plastiche e dello stampaggio rotazionale.

PASSION POUR L'EXPERIMENTATION

Teraplast est une nouvelle réalité dans le domaine des vases en plastique et se distingue par sa flexibilité, son innovation et sa gamme de produits. Nous produisons les articles avec une technologie d'injection et de rotation réussissant à satisfaire les besoins de secteurs bien diversifiés. Nous sommes également en mesure de réaliser, sur demande, tous les articles dans une large gamme de couleurs.

En mettant l'accent sur l'innovation, Teraplast est orientée vers l'expérimentation et la recherche au-delà des limites des matériaux, des technologies et des formes, pour arriver à créer des produits innovants, sources d'inspiration et de plaisir pour les yeux.

Grâce à ses produits Teraplast continue la tradition d'excellence qui a toujours été associée à la marque Made in Italy, alliant la fonctionnalité du vase à la dimension esthétique.

L'élargissement de la gamme avec l'introduction de mobiliers d'extérieur a été la conséquence directe de la philosophie d'entreprise, et a conduit à la création de sièges, tables et lampes, réinventés, pour donner aux locaux extérieurs la même finesse qu'aux locaux intérieurs.

Qu'il s'agisse d'un vase, d'une table géométrique ou d'un objet design, les produits Teraplast captent l'attention et sont conçus pour être à la fois fonctionnels et fascinants, en témoignant l'excellente capacité d'élaboration dans le domaine du plastique et du rotomoulage.



PASSION FOR INNOVATION

Teraplast is a new player in the plastic pot sector and stands out for its flexibility, innovation, range and particularly competitive prices. We produce articles with injection and rotational technology and we are able to satisfy the requirements of diversified sectors. In addition we can produce, on request, all the articles in a wide range of colours and sizes.

We are able to satisfy the needs of the most demanding customers providing customised services like design and production of moulds, process of various materials, final assembling of special components and provide suitable packaging.

With its inclination to innovation, Teraplast focuses on experimentation and the search beyond the limits of materials, of technologies and forms, in order to create innovative products which are sources of inspiration and pleasing to the eye. Thanks to its products, Teraplast continues on with the tradition of excellence that for a long time has been linked to the Made in Italy mark, succeeding in conjugating the functionality of the vase and the aesthetic dimension.

The product range expansion through the introduction of outdoor furniture has been the direct consequence of the business philosophy, and the result is the creation of seats, tables and lamps, redesigned to give the outdoor environment the same refinement of the interior one.

Whether it is a pot, a geometric table or a design object, the Teraplast products capture the attention and are conceived to be both functional and fascinating, attesting the excellent ability of workmanship in the plastic field and the rotational moulding.

LEIDENSCHAFT FÜR DAS EXPERIMENTIEREN

Teraplast ist eine neue Realität in Bereich der Plastikvasen, die sich durch Flexibilität, Innovation und ihre Produktpalette absetzt. Wir produzieren unsere Produkte durch Injektions- und Rotationstechnologie und können somit die Bedürfnisse diversifizierter Bereiche zufrieden stellen. Darüber hinaus sind wir in der Lage, bei Anfrage, alle Artikel in einer weitreichenden Farbskala zu realisieren.

Mit seiner Neigung zur Innovation orientiert sich Teraplast an das Experimentieren und an die Forschung jenseits der materialistischen, technischen und formbedingten Grenzen mit dem Ziel, innovative Produkte, Inspirationsquellen und genussvolle Anblicke zu kreieren. Dank seiner Produkte verfolgt Teraplast weiterhin die Tradition von Exzellenz, die seit jeher mit dem Siegel Made in Italy assoziiert wird. Somit gelingt es, die Funktionalität der Vase mit der ästhetischen Dimension zu vereinen.

Der Ausbau der Produktpalette mit der Einführung der Einrichtungsgegenstände für den Außenbereich war die direkte Konsequenz der Unternehmensphilosophie. So entstanden Sitzgelegenheiten, Tische und Lampen, die neu ausgedacht wurden, um den Außenbereichen die gleiche Finesse wie den Innenbereichen zu verleihen.

Ob es sich um eine Vase, einem geometrischen Tisch oder einem Designobjekt handelt, die Produkte von Teraplast ziehen die Aufmerksamkeit auf sich und sind so konzipiert, dass sie sowohl funktional als auch faszinierend sind.

Dies ist das Zeugnis der ausgezeichneten Fähigkeit in dem Kunststoff- und Rotationsverfahrensbereich zu operieren.



I prodotti Teraplast hanno un animo green. Infatti sono realizzati con plastica al 100% riciclata e riciclabile di qualità che permette la realizzazione di prodotti molto resistenti, ma allo stesso tempo leggeri e maneggevoli.

Teraplast products have a „green soul“, they are complete good quality recycled and recyclable plastic that allows to obtain very resistant and at the same time light and manageable products.

Les produits Teraplast ont une “âme verte“, en effet ils sont produits avec du plastique entièrement recyclable et de bonne qualité qui permet la réalisation de produits très durables, mais en même temps légers et maniables.

Die Teraplast Produkte haben eine “grüne Seele“, sie werden mit Kunststoffmaterial hergestellt, das vollständig wiederverwendet werden kann und dessen Qualität die Herstellung von Produkten ermöglicht die beständig aber gleichzeitig leicht und einfach zu handhaben sind.

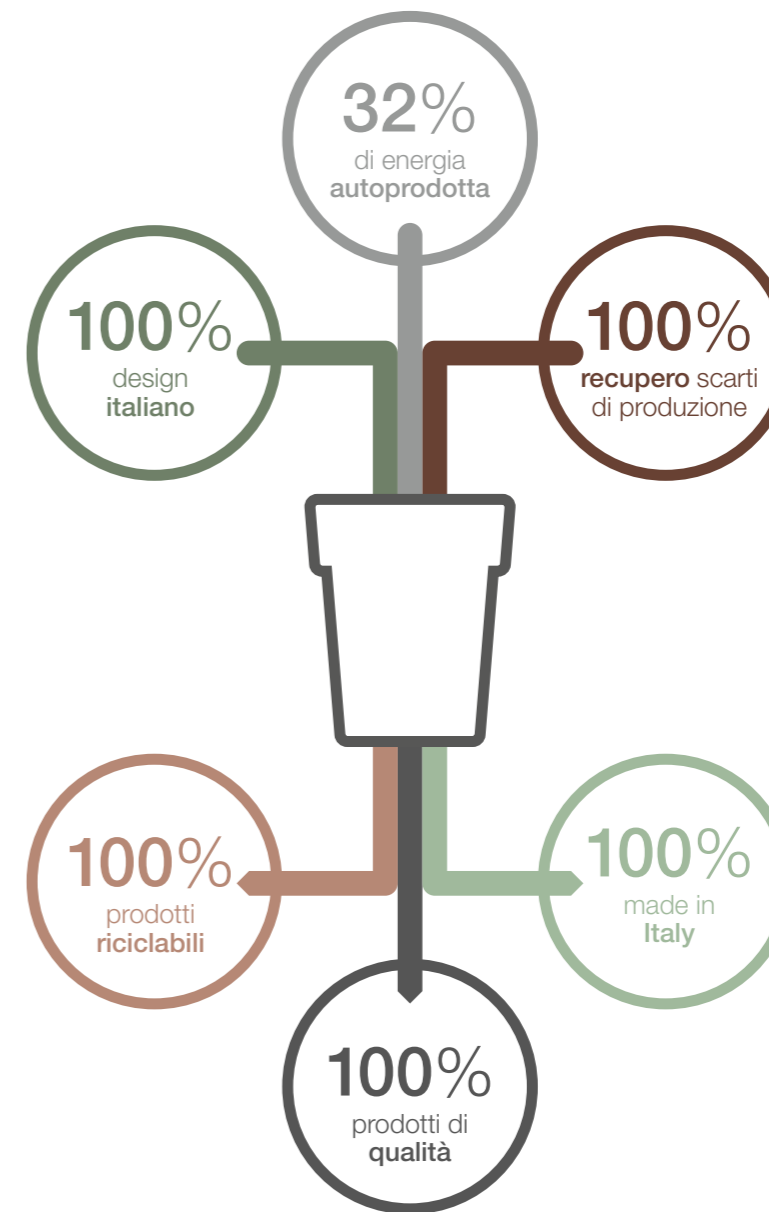

Il reparto rifinitura, il reparto di stampaggio iniezione e il nostro magazzino di 8.000 m2 sono dotati di luci led, inoltre il 19 febbraio abbiamo partecipato a #Milluminodimeno la più grande campagna radiofonica di sensibilizzazione sui consumi energetici e la mobilità sostenibile, ideata da Caterpillar.

The finishing department, injection molding department and our warehouse of 8.000 m2 are equipped with LED lights. On February 19th we participated at #Milluminodimeno the largest radio awareness campaign on energy consumption and sustainable mobility, conceived by Caterpillar.

Le département de finissage, le département de moulage injecté et notre entrepôt de 8.000 m2 sont équipés de lumières LED. Le 19 Février nous avons participé à #Milluminodimeno la plus grande campagne de sensibilisation à la radio sur la consommation d'énergie et de la mobilité durable, conçu par Caterpillar.

Die Abteilung der Endbearbeitung, die Spritzguss-Abteilung und unser Lager von 8.000 m2 sind mit LED-Beleuchtung ausgestattet. Am 19. Februar haben wir am #Milluminodimeno teilgenommen, die größte Radiosensibilisierungskampagne für den Energieverbrauch und für eine umweltgerechte Mobilität, die von Caterpillar ausgedacht wurde.

I prodotti Teraplast hanno un animo green

Teraplast products have a green soul

Les produits Teraplast ont une âme verte

Die Teraplast Produkte haben eine grüne Seele



Teraplast è dotata di un impianto fotovoltaico per l'autoproduzione di energia elettrica di potenza 1017 kW che copre una superficie di 24790 m2, che permette l'autoproduzione del 32% dell'energia che ci serve per la trasformazione della materia prima.

Teraplast is equipped with a photovoltaic system, that covers an area of 24.790 m2, for the self-production of electricity of 1017 kW. This allows the self-production of 32% of the energy we need for the transformation of the raw material.

Teraplast est équipé d'un système photovoltaïque, qui couvre une surface de 24.790 m2, pour l'autoproduction d'électricité de 1017 kW. Ça nous permet de produire 32% de l'énergie dont nous avons besoin pour la transformation de la matière première.

Teraplast ist mit einer Photovoltaik-Anlage für die Eigenproduktion von Strom von 1017 kW ausgestattet, diese umfasst eine Fläche von 24.790 m2. Dadurch wird 32% der Energie, die für die Umwandlung des Rohmaterials benötigt wird, erzeugt.

RE AS IN Recycled

TERAPLAST LANCIA
NEL MERCATO LA NUOVA
LINEA RE COMPOSTA
DA VASI E SASSI PRODOTTI AL
100% CON PLASTICA RICICLATA:

TERAPLAST IS LAUNCHING ITS NEW RE RANGE OF
POTS AND PEBBLES MADE OF **100% RECYCLED**
PLASTIC:

TERAPLAST LANCE SUR LE MARCHÉ SA
NOUVELLE GAMME RE, COMPOSÉE DE POTS
ET DE CAILLOUX FABRIQUÉS À **100% AVEC DU**
PLASTIQUE RECYCLÉ:

TERAPLAST BRINGT DIE NEUE, ZU **100% AUS**
RECYCELTEM KUNSTSTOFF HERGESTELLTE LINIE
RE MIT PFLANZGEFÄSSEN UND STEINEN AUF
DEN MARKT:

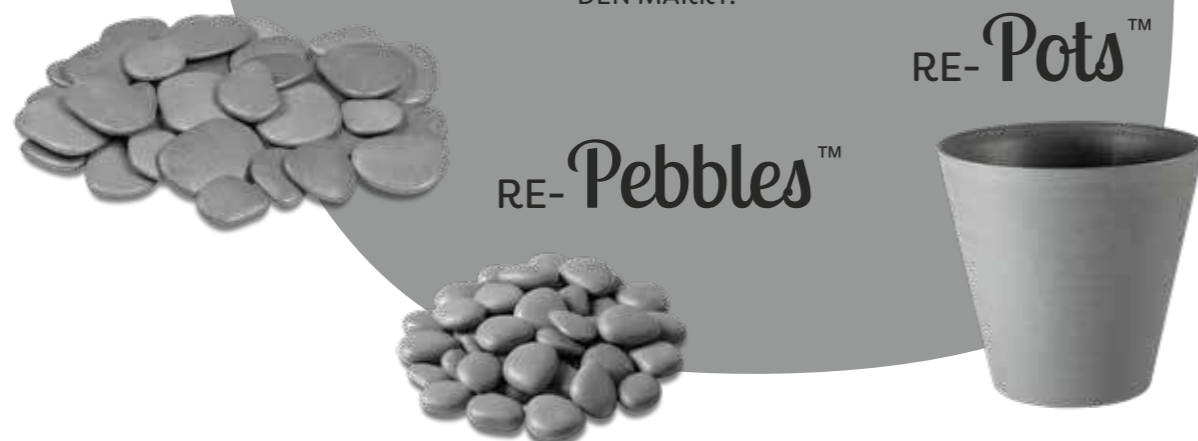

La plastica è un materiale versatile, in molti settori è stata impiegata come valido sostituto per altri tipi di materiali recando numerosi vantaggi e prestazioni addirittura migliori in termini tecnici ed economici. Se si prende in considerazione l'intero ciclo di vita, la plastica può essere considerata uno dei materiali più efficienti dal punto di vista energetico.*

Plastic is a versatile material and it has been used as a sound replacement for other types of materials in many fields. It offers many benefits, including better performance in technical and economic terms. If its entire lifecycle is taken into consideration, plastic can be considered one of the most energy-efficient materials of all.*



Le plastique est un matériau versatile. Il a été utilisé dans un grand nombre de secteurs pour remplacer parfaitement d'autres types de matériaux, offrant de nombreux avantages et de meilleurs résultats en termes de technicité et d'économies.

Si l'on prend en considération tout son cycle de vie, le plastique peut être considéré comme l'un des matériaux les plus efficaces du point de vue énergétique.*

Kunststoff ist ein vielseitiges Material, das in vielen Branchen als Ersatz für andere Materialien verwendet wird und zahlreiche Vorzüge sowie sogar bessere technische und wirtschaftliche Eigenschaften zu bieten hat. Betrachtet man den gesamten Lebenszyklus, so zählen Kunststoffe zu den energieeffizientesten Materialien.*

PERCHÉ RICICLARE LA PLASTICA?

Il riciclaggio della plastica contribuisce a:

- Ridurre i rifiuti di plastica in discarica;
- Evitare il consumo di petrolio;
- Decrescere l'uso di energia elettrica ed emissioni di CO₂;
- Fornire materiale riciclato per produrre nuovi oggetti.

WHY RECYCLE PLASTIC?

Recycling plastic helps to:

- Reduce plastic waste on landfill sites;
- Avoid oil consumption;
- Cut electricity use and CO₂ emissions;
- Provide recycled material for making new products.

POURQUOI RECYCLER LE PLASTIQUE ?

Le recyclage du plastique contribue à:

- réduire la présence des déchets plastiques dans les décharges;
- éviter la consommation de pétrole;
- diminuer l'utilisation de l'énergie électrique et les émissions de CO₂;
- fournir un matériau recyclé permettant de fabriquer de nouveaux objets.

WARUM SOLLTE KUNSTSTOFF RECYCELT WERDEN?

Kunststoffrecycling trägt dazu bei:

- Die Kunststoffabfälle auf Deponien zu reduzieren;
- Erdölverbrauch zu vermeiden;
- Den Stromverbrauch und die CO₂-Emissionen zu senken;
- Recyceltes Material für die Herstellung neuer Artikel bereitzustellen.

Cosa significa RESPECT INSIDE?

I nostri prodotti sono:

- Sostenibili: sono prodotti al 100% in materiale riciclato.
- Eco-friendly: sono 100% riciclabili.
- Rispettosi delle future generazioni: utilizzando materiale riciclato per la produzione di nuovi beni si riducono impatto ambientale del processo produttivo e sprechi.

What does RESPECT INSIDE mean?

Our products are:

- Sustainable: they are made of 100% recycled materials.
- Eco-friendly: they are 100% recyclable.
- Made in the interest of future generations: using recycled materials to make new goods reduces waste and the environmental impact of the production process.

Que signifie RESPECT INSIDE?

Nos produits sont:

- durables: ils sont produits à 100 % en matériau recyclé.
- respectueux de l'environnement: ils sont 100 % recyclables.
- respectueux des générations futures: en utilisant un matériau recyclé pour fabriquer de nouveaux biens, on réduit l'impact environnemental lié au procédé de fabrication et aux gaspillages.

Was bedeutet RESPECT INSIDE?

Unsere Produkte sind:

- Nachhaltig: Sie sind zu 100% aus recyceltem Material hergestellt.
- Umweltfreundlich: Sie sind zu 100% recycelbar.
- Ethisch vertretbar in Hinblick auf die zukünftigen Generationen: Die Verwendung von recyceltem Material zur Herstellung neuer Produkte reduziert die Umweltbelastung durch den Produktionsprozess und den Abfall.

* Fonte: Denkstatt GmbH, L'impatto delle materie plastiche sul consumo energetico e sulle emissioni di gas serra lungo il loro ciclo di vita in Europa, Relazione sintetica Giugno 2010. Source: Denkstatt GmbH, The impact of plastics on life cycle energy consumption and greenhouse gas emissions in Europe, Concise Report, June 2010. Source: Denkstatt GmbH, L'impact des matières plastiques sur la consommation d'énergie et sur les émissions de gaz à effet de serre pendant leur cycle de vie en Europe, Rapport de synthèse, Juin 2010. Quelle: Denkstatt GmbH, Die Auswirkungen von Kunststoffen auf Energieverbrauch und Treibhausgasemissionen in Europa, Zusammenfassender Bericht Juni 2010.

RE AS IN Recycling

FAI LA RACCOLTA DIFFERENZIATA!

Un rifiuto può diventare una preziosa risorsa, per la creazione di nuovi prodotti o per generare energia.



SORT YOUR WASTE!

Waste can become a precious resource, either for making new products or for generating energy.

OPTEZ POUR LE TRI SÉLECTIF!

Un déchet peut devenir une ressource précieuse, afin de créer de nouveaux produits ou de générer de l'énergie.

MACHEN SIE MIT BEI DER ABFALLTRENNUNG!

Ein Abfall kann zu einer wertvollen Ressource werden, sei es für die Herstellung neuer Produkte oder für die Energiegewinnung.

4
Riduzione in granuli.
Breaking down into granules.
Réduction en granules.
Verarbeitung zu Granulat.

5
Nuovi prodotti.
New products.
Nouveaux produits.
Neue Produkte.

5
Produzione di energia, calore ed elettricità.
Production of energy, heat and electricity.
Production d'énergie, de chaleur et d'électricité.
Energie-, Wärme- und Stromerzeugung.

4
L'energia prodotta sostituisce i combustibili fossili nei processi industriali.
The energy produced replaces fossil fuels in industrial processes.
L'énergie produite remplace les combustibles fossiles dans les processus industriels.
Die erzeugte Energie ersetzt fossile Brennstoffe in industriellen Prozessen.

3
Lavaggio e separazione dei fiocchi.
Washing and separating flakes.
Lavage et séparation des flocons.
Waschen und Trennen der Flocken.

3
Le emissioni sono sempre controllate.
The emissions are always monitored.
Les émissions sont toujours contrôlées.
Die Emissionen werden ständig überwacht.

2
Sminuzzamento.
Shredding.
Broyage.
Zerkleinerung.

1
Raccolta differenziata.
Waste sorting.
Tri sélectif.
Abfalltrennung.

1
Raccolta differenziata.
Waste sorting.
Tri sélectif.
Abfalltrennung.

2
Alcuni tipi di plastica non riciclabile sono trattati con impianti specializzati in grado di convertire i rifiuti in energia. | Some types of non-recyclable plastic are processed in plants that can convert waste into energy. | Certains types de plastique non recyclable sont traités dans des installations capables de convertir les déchets en énergie. | Einige nicht recycelbare Kunststoffe werden in Anlagen behandelt, die Abfälle in Energie umwandeln.

LA PLASTICA È UN MATERIALE SOSTENIBILE PER L'AMBIENTE IN QUANTO È RICICLABILE AL 100%.

Un oggetto in plastica anche quando è gettato nel cestino come rifiuto si rivela **una risorsa utile** che può essere sfruttata nuovamente grazie alla raccolta differenziata. Sarebbe uno spreco gettare la plastica nel rifiuto indifferenziato destinato alla discarica e non reinserirla nel processo di riciclaggio.

Infatti un prodotto in plastica che ha raggiunto la fine del suo ciclo di vita può essere riciclato e reinserito nel sistema produttivo per creare un prodotto con la **qualità equivalente al prodotto originario** da cui si è partiti.

Inoltre si possono utilizzare i rifiuti in plastica **anche per produrre energia** che può essere impiegata per alimentare i processi produttivi di un'impresa al posto del combustibile fossile.

La plastica è un materiale nuovo, il cui uso si è diffuso solo nel XXI secolo. Per questo motivo essa alimenta continui studi e ricerche finalizzati a rintracciare procedimenti di lavorazione delle materie plastiche sempre più efficienti dal punto di vista ambientale ed economico.

PLASTIC IS AN ENVIRONMENTALLY SUSTAINABLE MATERIAL BECAUSE IT IS 100% RECYCLABLE.

Even after plastic items have been thrown away, they can be **useful resources** that can be used once again thanks to waste sorting. It would be a real waste to throw plastic away with the normal rubbish that is sent to landfill sites instead of putting it through the recycling process.

After all, plastic items at the end of their lifecycles can be recycled and put back into the production system to create products of **the same quality as the original items**.

In addition, plastic waste can be used **to generate energy** that can be used in production processes instead of fossil fuels.

Plastic is a new material that only came into really widespread use in the 21st century. Therefore, it is constantly the subject of studies and research that aim to find plastic material processing procedures that are more and more efficient from an environmental and economic point of view.

LE PLASTIQUE EST UN MATÉRIAU DURABLE POUR L'ENVIRONNEMENT PUISQU'IL EST RECYCLABLE À 100%.

Même jeté dans la poubelle comme déchet, un objet en plastique est une **ressource utile** pouvant être à nouveau exploitée grâce au tri sélectif. Ce serait gaspillé que de jeter le plastique dans le tri non sélectif destiné à la décharge et de ne pas le réintégrer dans le processus de recyclage.

En effet, un produit en plastique qui a atteint la fin de son cycle de vie peut être recyclé et réintégré dans le système de production, afin de concevoir un produit **de qualité équivalente au produit d'origine**, qui sert de base.

Par ailleurs, il est possible d'utiliser également les déchets en plastique pour **générer de l'énergie** pouvant simplement être utilisée pour alimenter les processus de production d'une entreprise à la place du combustible fossile.

Le plastique est un matériau nouveau, dont l'utilisation a seulement commencé à se répandre au XXIe siècle. Voilà pourquoi il est l'objet d'études et de recherches continues visant à identifier des processus d'élaboration des matières plastiques de plus en plus efficaces du point de vue environnemental et économique.

KUNSTSTOFFE SIND UMWELTFREUNDLICH, DA SIE ZU 100% RECYCELBAR SIND.

Auch wenn ein Kunststoffgegenstand als Abfall in den Müll-eimer geworfen wird, erweist er sich als **nützliche Ressource**, die durch die Abfalltrennung wiederverwertet werden kann. Es wäre Verschwendung, Kunststoff in den unsortierten Abfall zu werfen, der deponiert und nicht dem Recyclingprozess zurückgeführt wird.

Denn ein Kunststoffprodukt, welches das Ende seines Lebenszyklus erreicht hat, kann recycelt und dem Produktionssystem wieder zurückgeführt werden, um ein Produkt **in der gleichen Qualität wie das Ursprungsprodukt** herzustellen.

Darüber hinaus können Kunststoffabfälle anstelle von fossilen Brennstoffen auch **zur Erzeugung von Energie** für die Produktionsprozesse eines Unternehmens genutzt werden.

Kunststoff ist ein neues Material, das erst im 21. Jahrhundert Verbreitung fand. Deshalb werden kontinuierlich Studien und Forschungen betrieben, die darauf abzielen, immer umweltfreundlichere und wirtschaftlichere Kunststoffverarbeitungsprozesse zu entwickeln.

COME SONO fatti? ♻️

HOW ARE THEY MADE?
COMMENT SONT-ILS FAITS?
WIE WERDEN SIE HERGESTELLT?

AL 100% IN PLASTICA RICICLATA

La plastica ha un'economia circolare:

FROM 100% RECYCLED PLASTIC

Plastic has a circular economy:

À 100% EN PLASTIQUE RECYCLÉ

L'économie du plastique est circulaire:

ZU 100% AUS RECYCELTEM KUNSTSTOFF

Kunststoffe in der Kreislaufwirtschaft:

La plastica viene divisa per colore e ridotta in granuli adatti allo stampaggio di nuovi prodotti.
Plastic is sorted by colour and broken down into granules that can be moulded into new products.
Le plastique est divisé par couleur et réduit en granules adaptés au moulage de nouveaux produits.
Die Kunststoffe werden nach Farbe getrennt und zu Granulaten für die Herstellung neuer Produkte verarbeitet.

Al centro di raccolta i diversi tipi di plastica vengono separati e lavati per essere riutilizzati nel modo più efficace.
In collection centres, the different types of plastic are separated and washed so that they can be reused as effectively as possible.
Au centre de collecte, les différents types de plastique sont séparés et traités pour être réutilisés de manière plus efficace.
In der Sammelstelle werden die verschiedenen Kunststoffe getrennt und gewaschen, um eine möglichst effiziente Wiederverwertung zu ermöglichen.

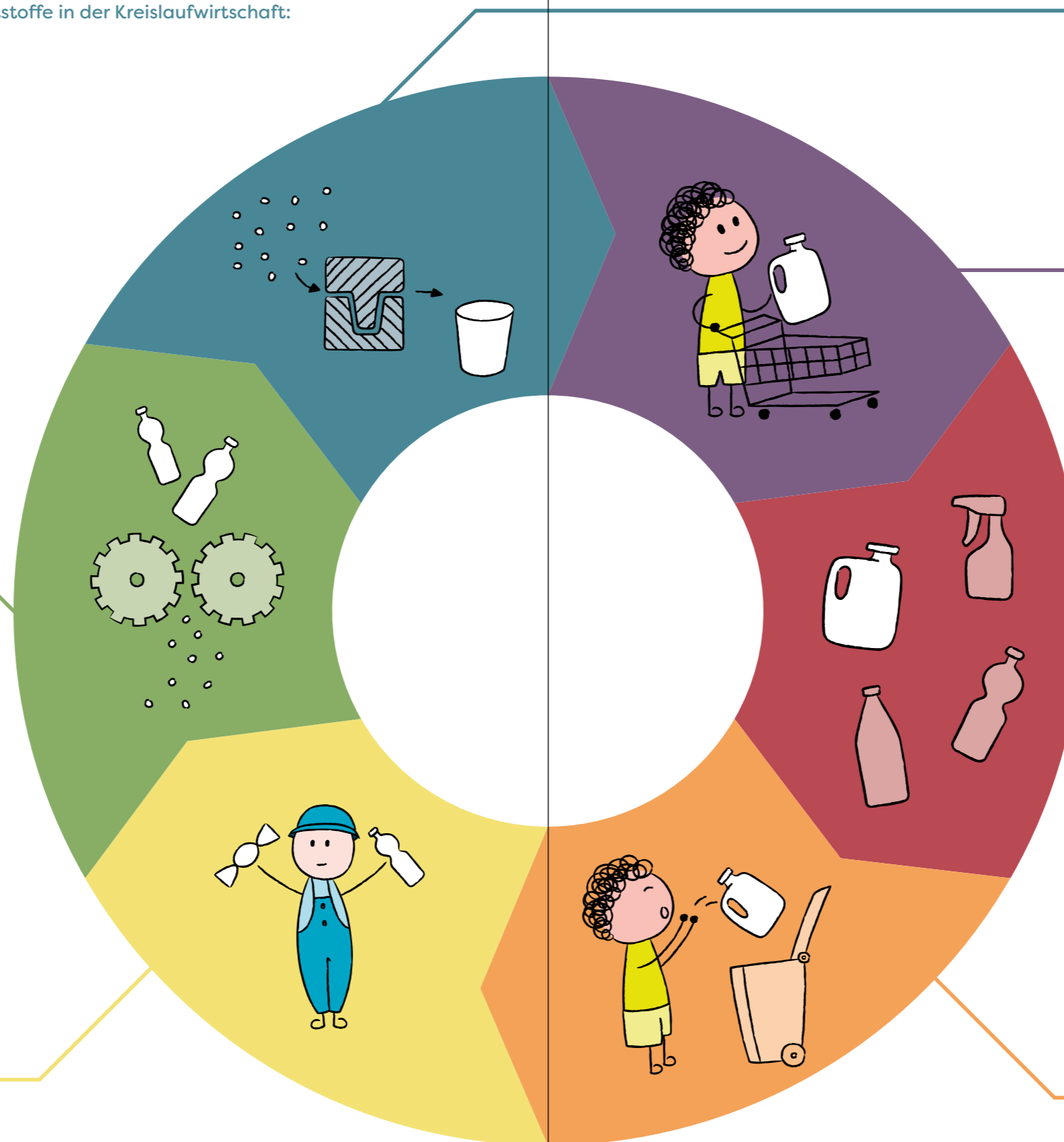

Teraplast utilizza i granuli 100% riciclati per creare i prodotti della linea RE, senza aggiungere altre sostanze o coloranti.

Teraplast uses 100% recycled granules to make the products in the RE range, without adding other substances or colourings.

Teraplast utilise des granules 100% recyclés pour créer les produits de sa gamme RE, sans ajouter d'autres substances ou colorants.

Teraplast verwendet zur Herstellung der Produktlinie RE zu 100% recyceltes Granulat, ohne Zugabe von anderen Stoffe oder Farbstoffen.

Molti dei prodotti che acquistiamo sono fatti di plastica.

Many of the products that we buy are made of plastic.

Une majorité des produits que nous achetons est en plastique.

Viele der von uns gekauften Produkte sind aus Kunststoff.

E gran parte di questa plastica è riciclabile.

The majority of this plastic is recyclable.

Et une grande partie de ce plastique est recyclable.

Und ein Großteil dieser Kunststoffe ist recycelbar.

Per questo è importante separare la plastica facendo la raccolta differenziata.

Therefore, it is important to sort your waste and pick out the plastic for recycling.

Il est donc important de séparer le plastique en procédant au tri sélectif.

Aus diesem Grund ist es wichtig, den Kunststoff durch Abfalltrennung auszusortieren.

RE AS IN Revolutionary

I PRODOTTI DELLA LINEA **Re**
SONO RICICLATI E RICICLABILI
AL 100%

THE PRODUCTS IN THE **Re**
RANGE ARE **100% RECYCLED AND**
RECYCLABLE

LES PRODUITS DE LA GAMME **Re**
SONT RECYCLÉS ET RECYCLABLES À
100%

DIE PRODUKTE DER LINIE **Re**
SIND RECYCLET UND RECYCELBAR:
ZU 100%

- HANNO COLORI UNICI, DERIVATI DAL RICICLAGGIO DELLA PLASTICA
- HANNO COLORI NEUTRI FACILI DA ABBINARE A QUALSIASI TIPO DI ARREDAMENTO
- DESIGN E PRODUZIONE SONO MADE IN ITALY
- LEURS COULEURS SONT UNIQUES, ISSUES DU RECYCLAGE DU PLASTIQUE
- LEURS COULEURS NEUTRES SONT FACILES À ASSORTIR À TOUT TYPE DE DÉCOR
- CONCEPTION ET PRODUCTION "MADE IN ITALY"
- THEY COME IN UNIQUE COLOURS THAT ARE A PRODUCT OF THE PLASTIC RECYCLING PROCESS
- THEIR NEUTRAL HUES ARE EASY TO MATCH WITH ALL KINDS OF FURNITURE
- THEY ARE DESIGNED AND MADE IN ITALY
- IHRE EINZIGARTIGEN FARBEN GEHEN AUF DAS KUNSTSTOFFRECYCLING ZURÜCK
- SIE HABEN NEUTRALE FARBEN, DIE ZU JEDEM EINRICHTUNGSSTIL PASSEN
- SIE WERDEN IN ITALIEN DESIGNT UND HERGESTELLT



Ecologico: atossico e riciclabile
Ecological: non-toxic and recyclable
Ecologique: recyclable et non toxique
Umweltfreundlich: nicht toxisch und recyclingsfähig

Siamo molto orgogliosi del nostro impianto fotovoltaico da 1,17 MW, posizionato sui tetti dei reparti produttivi e del magazzino, con il quale produciamo energia pulita per poter produrre i nostri vasi. Questa scelta, insieme all'utilizzo di materie prime riciclate di alta qualità e a politiche atte ad evitare sprechi in fase di imballaggio, rende Teraplast uno dei produttori di vasi più sostenibile.

We are very proud of our photovoltaic installation of 1,17 MW, placed on the roof of our production and warehouse, wherewith we produce clean energy to produce our pots. This choice, together with the use of high quality recycled raw material and strict policies to avoid wastes in the packaging process, emphasizes Teraplast as one of the most environmental friendly company.

Nous sommes très fiers de notre installation photovoltaïque de 1,17 MW, positionné sur les toits des rayons productifs et du magasin avec laquelle nous produisons énergie propre pour pouvoir produire nos vases. Avec le choix d'utiliser des matières premières recyclées de haute qualité en contribuant à la politique d'antigaspiages en phase d'emballage, Teraplast devient un des producteurs de vases les plus respectables.

Wir sind sehr stolz auf unsere Photovoltaikanlage mit 1,17 MW, auf dem Werk- und Lagerdach, womit wir saubere Energie erzeugen, um unsere Töpfe herzustellen. Diese Entscheidung, zusammen mit der Verwendung von recycelt hochwertigen Rohstoffe und ohne Verschwendungen in der Verpackungsphase, macht TeraPlast einer der am nachhaltigsten Hersteller von Pflanzgefäße.



Inalterabile nel colore
Colourfast dyes
Inalterabilité des couleurs
Farbbeständig



Resistente al caldo e al freddo
Warm and cold resistant
Résistant à la chaleur et au froid
Wetterfest



Prodotto al 100% con plastica riciclata
They are made of 100% recycled plastic
Fabriqué à 100 % en plastique recyclé
Zu 100% aus recyceltem Kunststoff hergestellt

Sono prodotti puliti e igienici.
They are clean, hygienic products.
Ces produits sont propres et hygiéniques.
Die Produkte sind sauber und hygienisch.



Self Watering
SELF WATERING

La riserva d'acqua permette di alimentare le vostre piante senza bisogno di irrigarle spesso.

Water system allows to feed plants without needing to irrigate it often.

La réserve d'eau permet d'alimenter vos plantes sans besoin de leur irriguer souvent.
Das Wasser-Reservoir ermöglicht es, die Pflanzen zu versorgen, ohne oft zu gießen.



Impilabile
Stackable
Impilables
Stapelbar

Per agevolare il trasporto e la vendita a scaffale molti dei nostri vasi sono impilabili.
A wide range of our pots are stackable in order to ensure easy transportation and friendly merchandising.

Pour faciliter le transport et la vente en étagères beaucoup de nos vases sont impilables.

Unsere Pflanzgefäße sind stapelbar, um den Transport und den Verkauf auf Regale zu erleichtern.



Facilmente lavabile senza detersivi
Easy to wash without detergents
Très facile à entretenir
Einfach ohne Reinigungsmittel waschbar



Impedisce la formazione di muffe
They prevent mould from growing
Prévient la formation de moisissures
Verhindert Schimmelbildung



Evita l'annidamento di zanzare e altri insetti.
It stops mosquitoes and other insects from laying eggs.
Évite la nidation des moustiques et autres insectes.
Das Einnisten von Mücken und anderen Insekten wird verhindert.



Resistente agli urti
Shock resistant
Résistant aux chocs
Stoß und Bruchfest



Leggerissimo
Very light
Très léger
Sehr Leicht



Foro predisposto
Can be drilled to drainage
Trous de drainage prévus
Loch Vorsatz

I vasi con il foro predisposto possono essere facilmente forabili per permettere il drenaggio dell'acqua. Una volta effettuata questa operazione si consiglia l'abbinamento con il sottovaso adeguato.

Pre drilled pots can be easily drilled to allow the drain of the water. Once done this operation we recommend to combine them with the suitable saucer.

Les vases qui ont le trou prépercé peuvent favoriser le drainage de l'eau. Une fois cette opération effectuée veuillez demander conseil au distributeur afin de trouver le dessous de pot correspondant.

Pflanzgefäße mit vorgesehenem Loch sind einfach durchzulöchern für den Wasserdrenage. Nach dem Durchlöchern ist die Benutzung des passenden Untersetzers zu empfehlen.

RE AS IN Redecorate your living areas

RE-Pebbles™ possono risultare accessori decorativi molto versatili, che mantengono la forma e il colore nel tempo.

RE-Pebbles™ are highly versatile decorative accessories that keep their shape and colour over time.

Les RE-Pebbles™ sont des accessoires très polyvalents qui conservent leur forme et leur couleur au fil du temps.

RE-Pebbles™ sind sehr vielseitig einsetzbare Dekoelemente, die ihre Form und Farbe im Laufe der Zeit beibehalten.



GARDEN

Puoi decorare il giardino e gli spazi vuoti in casa, o creare giardini zen.

You can decorate your garden or empty spaces around the home, or make Zen gardens.

Vous pouvez décorer votre jardin et vos espaces vides chez vous, ou encore créer un jardin zen.

Sie können den Garten und leere Bereiche im Haus dekorieren oder Zen-Gärten anlegen.



POT

Puoi usarli come decorazione per il vaso.

They can be used as decorations in pots.

Vous pouvez les utiliser comme décoration de pot.

Sie können sie als Dekoration für Pflanzgefäße verwendet werden.



PET

Materiali atossici idonei per essere utilizzati per Acquari e Terrari.

The materials are non-toxic, so they are suitable for use in aquariums and terrariums.

Matériaux non toxiques adaptés à une utilisation pour les aquariums et les terrariums.

Für Aquarien und Terrarien geeignete ungiftige Materialien



Per creare soprammobili con i fiori recisi o per creare uno strato drenante.

You can use them to create ornaments with cut flowers or to make a drainage layer.

Pour créer des objets de décoration, comme des fleurs coupées, ou pour créer une couche drainante.

Für die Gestaltung von Dekorationen mit Schnittblumen oder für Drainageschichten



LANDSCAPE DESIGN & ARCHITECTURE

Puoi usarli come accessori o per realizzare progetti di arredo urbano, giardini, terrazzi, paesaggi e allestimenti.

You can use them as accessories in urban design projects, gardens, terraces, landscapes and decorative displays.

Vous pouvez les utiliser comme accessoire pour réaliser des projets de décoration urbaine, des jardins, des terrasses, des paysages et des aménagements.

Sie können sie für Stadtgestaltungs-, Garten-, Terrassen-, Landschafts- und Einrichtungsprojekte verwenden.



RE-POTS™ Hoop Water Reserve

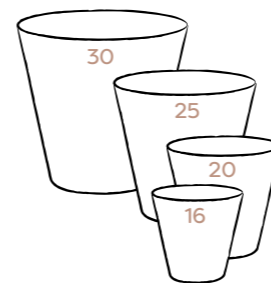
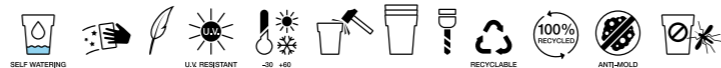

news
2018



Ogni pezzo ha un colore unico, non ne troverai un altro uguale

La diversa colorazione dipende dalla varietà di plastica riciclata utilizzata.

Every piece has its unique colour, you won't find an equal one.

The colour depends on the variety of plastic inside.

Chaque pièce a une couleur unique, vous n'en trouvez pas des égal.

La couleur dépend de la variété de plastique recyclé.

Jedes Stück hat eine einzigartige Farbe, keines sieht gleich aus.

Der Farbton hängt vom recycelten Kunststoffmix ab.



237
Bianco
White
Blanc
Weiß



239
Verde
Green
Vert
Grün

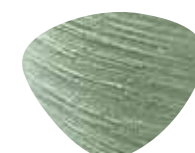

241
Grigio
Grey
Grisé
Grauer



240
Marrone
Brown
Marron
Braun



238
Nero
Black
Noir
Schwarz

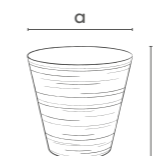
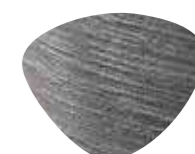

codice senza colore code without colour	Cm	dimensioni dimensions	litri liters	Confezione minima Minimum package	m ³	pezzi pallet pcs pallet	m ³		
33 703 016	16	a16 b15	1,6	12	17x33x31h	0,01	1176	80x120x230h	2,2
33 703 020	20	a20 b19	3,2	8	21x21x40h	0,01	800	80x120x215h	2,1
33 703 025	25	a25 b23,5	6,2	6	26x26x40,5	0,03	360	80x120x235h	2,2
33 703 030	30	a30 b28	11,8	6	31x31x45,5	0,04	192	80x120x193h	1,9

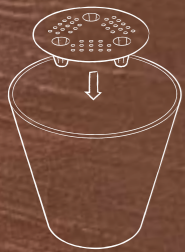

RISERVA D'ACQUA

La riserva d'acqua permette di alimentare le vostre piante senza bisogno di irrigarle spesso. I fori di drenaggio per il "troppo pieno" permettono di scaricare eventuali eccessi di acqua così sarà la pianta stessa ad attingere alla riserva d'acqua quando ne avrà bisogno.

Alcuni dei vasi dotati di questo sistema presentano anche una membrana di rivestimento che, una volta rimossa, permette all'acqua in eccesso di fuoriuscire dal vaso.

WATER RESERVE

The water reservoir allows to feed your plants without having to water it often.

The drainage holes for the "overflow" allow you to download any excess water so the plant itself will be to draw on the reserve of water when it needs them.

Some of the pots equipped with this system also have a coating membrane that, once removed, it allows excess water to leak from the pots.

RÉSERVE D'EAU

Le réservoir d'eau permet de nourrir vos plantes sans avoir à les arroser souvent. Les trous de drainage pour le «débordement» vous permettent de télécharger tout excès d'eau de sorte que sera elle-même à puiser dans la réserve d'eau quand il en aura besoin.

Certains des pots équipés de ce système ont également une membrane d'enrobage qui, une fois enlevé, permet à l'eau en excès de sortir

WASSER-RESERVOIR

Das Wasser-Reservoir ermöglicht, Ihre Pflanzen zu versorgen, ohne ständig Wasser zuzuführen.

Die Entwässerungslöcher lassen das Wasser überlaufen, damit die Pflanze das nach Bedarf schöpfen kann. Einige Pflanzgefäße mit Wasserspeicher besitzen eine Abdeckung-Membrane, die das Wasser, bei Wegnahme, überlaufen lässt.



diffusione dell'acqua per osmosi
water diffusion through osmosis's effect
diffusion de l'eau par osmose
Wasserdiffusion durch Osmose

riserva d'acqua
water reserve
réserve d'eau
Wasser-Reservoir

foro di drenaggio per l'acqua in eccesso
drainage bore for water's excess
trou de drainage pour l'eau en excès
Entwässerungsloch

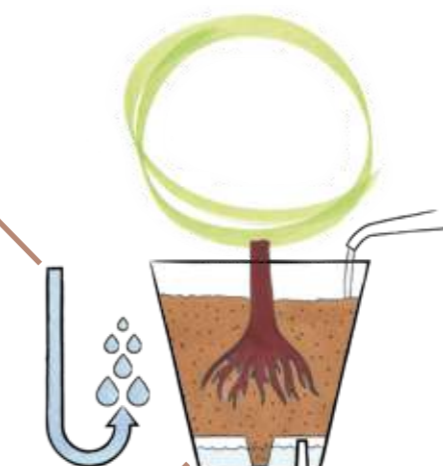

Addio zanzare, questa è una no-fly zone!

La riserva d'acqua impedisce alle zanzare di raggiungere l'acqua ferma sul fondo del vaso per depositare le uova.

Farewell mosquitoes, this is a no-fly zone.

The water reservoir prevents mosquitoes from reaching the water at the bottom of the pot to lay their eggs.

Moustiques adieu, Zone interdite au vol!

La réserve d'eau empêche les moustiques d'atteindre l'eau stagnante au fond du pot pour y déposer leurs œufs.

Flugverbotszone für Stechmücken!

Der Wasserspeicher verhindert, dass Mücken das stehende Wasser auf dem Boden des Pflanzgefäßes erreichen, um Eier zu legen.

RE-Pebbles™



news
2018

PERCHÉ ACQUISTARLI?

- PIÙ LEGGERI DEI SASSI COMUNI;
- PULITI, IGIENICI E ATOSSICI;
- INODORE;
- IMPEDISCONO LA FORMAZIONE DI MUFFE;
- FACILMENTE LAVABILI;
- RESISTENTI (PER USO INDOOR E OUTDOOR);
- COLORATI;
- ACCESSORI DECORATIVI DI DESIGN.

POURQUOI LES ACHETER?

- PLUS LÉGERS QUE LES CAILLOUX COMMUNS
- PROPRES, HYGIÉNIQUES ET NON TOXIQUES
- INODORES
- PRÉVIENNENT LA FORMATION DE MOISSURES
- FACILEMENT LAVABLES
- RÉSISTANTS (UTILISATION INTÉRIEURE ET EXTÉRIEURE)
- COLORÉS
- ACCESSOIRES DE DÉCORATION DESIGN.

WHY BUY THEM?

- THEY ARE LIGHTER THAN NORMAL PEBBLES.
- THEY ARE CLEAN, HYGIENIC AND NON-TOXIC.
- THEY ARE ODOURLESS.
- THEY PREVENT MOULD FROM GROWING.
- THEY ARE EASY TO WASH.
- THEY ARE DURABLE (FOR INDOOR AND OUTDOOR USE).
- THEY ARE COLOURFUL.
- THEY ARE DECORATIVE DESIGNER ACCESSORIES.

WARUM SOLLTE MAN SIE KAUFEN?

- LEICHTER ALS GEWÖHNLICHE STEINE;
- SAUBER, HYGIENISCH UND UNGIFTIG;
- GERUCHLOS;
- VERHINDERN SCHIMMELBILDUNG;
- LEICHT WASCHBAR;
- WIDERSTANDSFÄHIG (FÜR DEN INNEN-UND AUßENBEREICH);
- FARBIG;
- DEKORATIVE DESIGNELEMENTE.

Ogni pezzo ha un colore colore unico, non ne troverai un altro uguale

La diversa colorazione dipende dalla varietà di plastica riciclata utilizzata.

Every piece has its unique colour, you won't find an equal one.

The colour depends on the variety of plastic inside.

Chaque pièce a une couleur unique, vous n'en trouvez pas des égal.

La couleur dépend de la variété de plastique recyclé.

Jedes Stück hat eine einzigartige Farbe, keines sieht gleich aus.

Der Farbton hängt vom recycelten Kunststoffmix ab.

small



237 Bianco
White
Blanc
Weiß



239 Verde
Green
Vert
Grün



241 Grigio
Grey
Grise
Grauer



240 Marrone
Brown
Marron
Braun



238 Nero
Black
Noir
Schwarz

large



RE-Pebbles™ Confezioni

PACKS
EMBALLAGES
PACKUNGEN



Display
Carton
box



Clear Pot

small

superficie coperta cm
surface covered cm

33 700 004

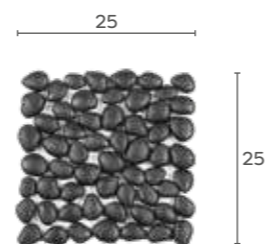

33 701 004

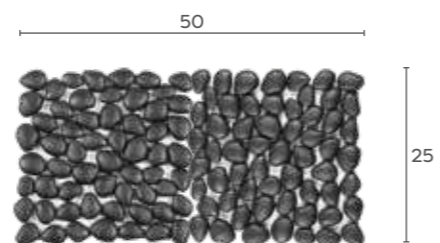

33 702 004

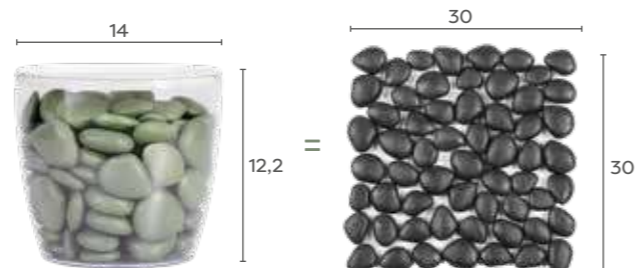

Riutilizza il vaso clear come vuoi!
You can reuse the clear pot as you want!
Vous pouvez réutiliser le pot transparent comme vous préférez.
Der durchsichtige Topf kann nach Belieben verwendet werden.

codice senza colore code without colour	Cm	misura size	superficie coperta cm surface covered cm	m ²	Confezione minima Minimum package	m ³	pezzi pallet pcs pallet	m ³
33 700 004	25x25	S	25x25	0,06	24 26x30x32,5h	0,03	648 80x120x112,5h	1,08
33 701 004	50x25	S	50x25	0,13	12 26x30x32,5h	0,03	324 80x120x112,5h	1,08
33 702 004	in clear pot	S	30x30	0,09	12 30x30,5x41,5h	0,04	192 80x120x98h	0,94

large

superficie coperta cm
surface covered cm

33 701 008

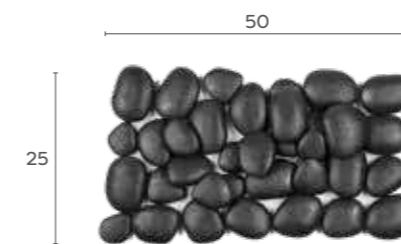

33 704 008

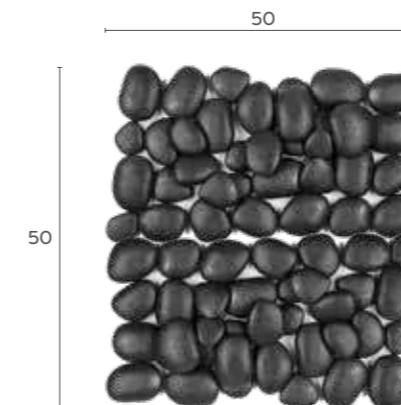

Display
Carton
box



codice senza colore code without colour	Cm	misura size	superficie coperta cm surface covered cm	m ²	Confezione minima Minimum package	m ³	pezzi pallet pcs pallet	m ³
33 701 008	50x25	L	50x25	0,13	12 26x30x32,5h	0,03	324 80x120x112,5h	1,08
33 704 008	50x50	L	50x50	0,25	6 26x36x31,5h	0,03	162 80x120x109,5h	1,05

news
2018

Intro Self Watering



Riserva d'acqua

La riserva d'acqua permette di alimentare le vostre piante senza bisogno di irrigarle spesso.

I fori di drenaggio per il "troppo pieno" permettono di scaricare eventuali eccessi di acqua così sarà la pianta stessa ad attingere alla riserva d'acqua quando ne avrà bisogno.

Alcuni dei vasi dotati di questo sistema presentano anche una membrana di rivestimento che, una volta rimossa, permette all'acqua in eccesso di fuoriuscire dal vaso.

Water reserve

The water reservoir allows to feed your plants without having to water it often.

The drainage holes for the "overflow" allow you to download any excess water so the plant itself will be to draw on the reserve of water when it needs them.

Some of the pots equipped with this system also have a coating membrane that, once removed, it allows excess water to leak from the pots.

Réserve d'eau

Le réservoir d'eau permet de nourrir vos plantes sans avoir à les arroser souvent. Les trous de drainage pour le «débordement» vous permettent de télécharger tout excès d'eau de sorte que sera elle-même à puiser dans la réserve d'eau quand il en aura besoin.

Certains des pots équipés de ce système ont également une membrane d'enrobage qui, une fois enlevé, permet à l'eau en excès de sortir

Wasser-Reservoir

Das Wasser-Reservoir ermöglicht, Ihre Pflanzen zu versorgen, ohne ständig Wasser zuzuführen.

Die Entwässerungslöcher lassen das Wasser überlaufen, damit die Pflanze das nach Bedarf schöpfen kann.

Einige Pflanzgefäße mit Wasserspeicher besitzen eine Abdeckung-Membrane, die das Wasser, bei Wegnahme, überlaufen lässt.

diffusione dell'acqua
per osmosi
water diffusion through
osmosis's effect
diffusion de l'eau par
osmose
Wasserdiffusion durch
Osmose

beccuccio per
inserimento dell'acqua
spout for water
insertion
bec pour l'introduction
de l'eau
Füllschacht zur
Wasserversorgung

griglia di drenaggio
drainage grid
gril pour le drainage
Bewässerungseinsatz

riserva d'acqua
water reserve
réserve d'eau
Wasser-Reservoir

Interessante? Gira
pagina e scopri
tutti!

Interesting, isn't it?
Go and find more!

Intéressant?
Blättern Sie weiter
und entdecken Sie
mehr!

Intéressant?
Tournez la page
pour en savoir plus!



Re-Pots™ Hoop
pagina 26



Stem
pagina 64



Stalk
pagina 66



Air
pagina 72



Hydral
pagina 74



Still
pagina 82



Aqua
pagina 84

Intro Self Watering



Molti dei nostri vasi sono dotati di **riserva d'acqua**. Scopri i dettagli nelle pagine dedicate.

Most of our pots are provided with **water reserve** system. Find more details on the related pages.

Plusieurs de nos pots sont équipés de **réserve d'eau**. Découvrez les détails dans les pages dédiées.

Wir bieten viele Blumenkästen mit **Bewässerungssystem** an. Entdecken Sie die Details auf die entsprechenden Seiten.



Estoril
pagina 122



Algarve
pagina 128



Cassetta Portofino
pagina 163



Cassetta Coste
pagina 166



Divio
pagina 233



Schio Cassa
pagina 235



Schio Cubo
pagina 234

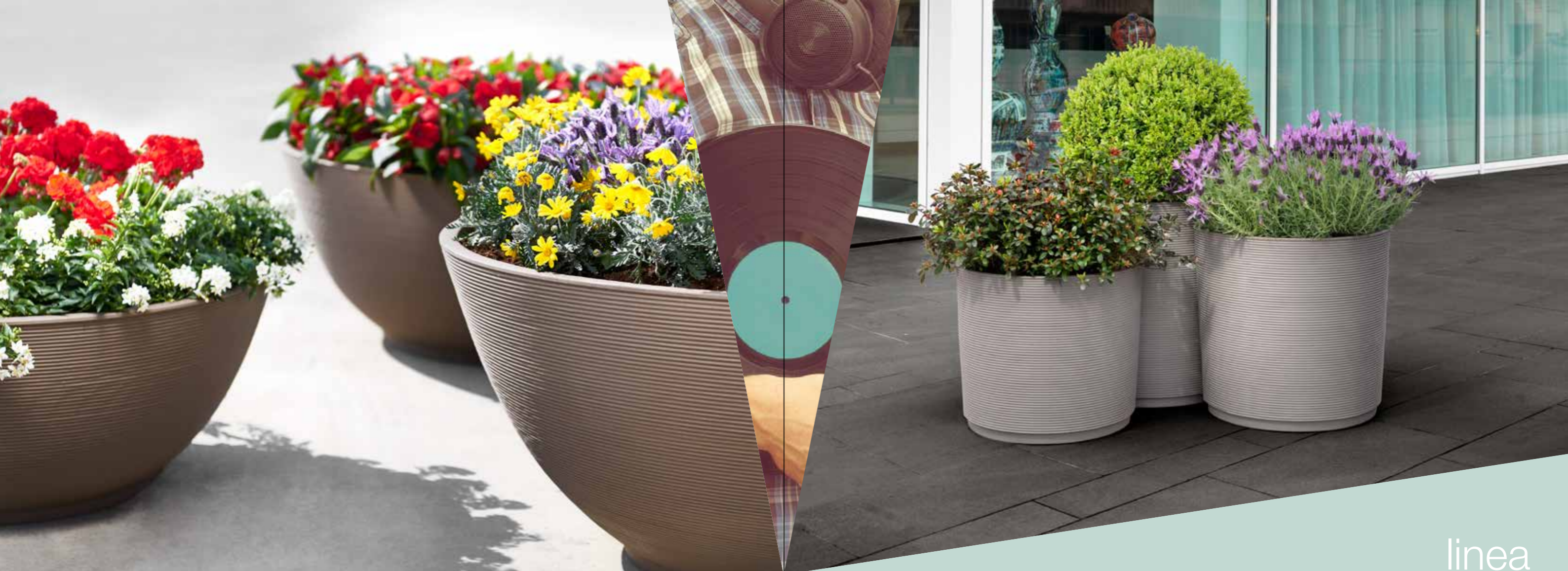

linea
GROOVE



Arena



Indy



Pixel



Ring



Urban

news
2018

Arena, Indy, Pixel, Ring e Urban sono accomunati da una splendida finitura.

Arena, Indy, Pixel, Ring and Urban have a stunning finish in common.

Arena, Indy, Pixel, Ring et Urban ont une superbe finition en commun.

Arena, Indy, Pixel, Ring und Urban haben alle eine ganz besondere Oberfläche



043

bianco/white
blanc/weiß



201

cappuccino/cappuccino
cappuccino/cappuccino



235

beton/beton
beton/beton

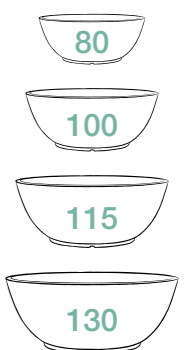
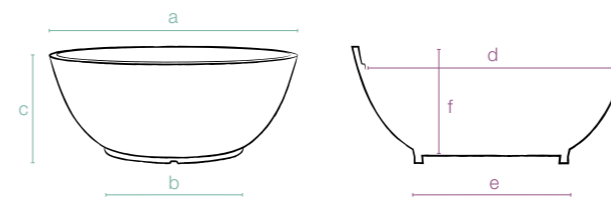

codice senza colore code without colour	Cm	dimensioni esterne external dimensions			dimensioni interne internal dimensions			litri liters	Confezione minima Minimum package	m ³	pezzi pallet pcs pallet	m ³
29 476 080	80	a80	b44	c32	d68,5	e43,5	f32	95	1 80x80x32h	0,20	8	80x80x113h 0,72
29 476 100	100	a100	b55	c40	d89	e54	f39	210	1 100x100x40h	0,40	7	100x100x116h 1,16
29 476 115	115	a115	b65	c46	d104	e63	f45	320	1 115x115x46h	0,61	6	115x115x116h 1,53
29 476 130	130	a130	b73	c52	d118	e71	f50	460	1 130x130x52h	0,88	5	130x130x118h 1,99



Arena



032

antracite/anthracite
anthracite/anthrazitgrau



039

bronzo/bronze
bronze/bronze



030

antico/light brown
marron clair/hellbraun

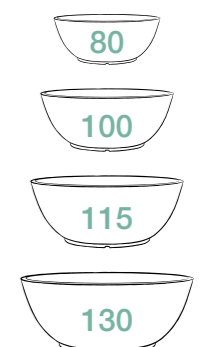
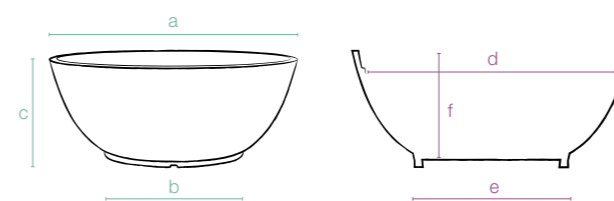

codice senza colore code without colour	Cm	dimensioni esterne external dimensions			dimensioni interne internal dimensions			litri liters	Confezione minima Minimum package	m³	pezzi pallet pcs pallet	m³
29 476 080	80	a80	b44	c32	d68,5	e43,5	f32	95	1 80x80x32h	0,20	8	80x80x113h 0,72
29 476 100	100	a100	b55	c40	d89	e54	f39	210	1 100x100x40h	0,40	7	100x100x116h 1,16
29 476 115	115	a115	b65	c46	d104	e63	f45	320	1 115x115x46h	0,61	6	115x115x116h 1,53
29 476 130	130	a130	b73	c52	d118	e71	f50	460	1 130x130x52h	0,88	5	130x130x118h 1,99

Creare una riserva d'acqua in pochi semplici passaggi:

How to create a water reserve in a few simple steps:

Comment créer une réserve d'eau en quelques étapes simples :

In wenigen einfachen Schritten einen Wasserspeicher anlegen:

1.

Con il trapano fai un foro in un punto qualsiasi nella parte bassa del vaso.

Use a drill to make a hole wherever you like towards the bottom of the pot.

Faites un trou avec une perceuse dans un point quelconque de la partie basse du pot.

Mit der Bohrmaschine eine Bohrung an einem beliebigen Punkt des unteren Bereichs des Pflanztrogs ausführen.



2.

Inserisci uno strato di argilla sul fondo

Add a layer of clay pebbles on the bottom

Ajouter une couche d'argile sur le fond

Eine Schicht Tongranulat am Boden einschichten



3.

Poi stendi il tessuto non tessuto

Then spread out the nonwoven fabric

Étirer le tissu non tissé

Dann das Vlies auslegen



4.

Riempi il vaso di terra

Fill the pot with topsoil

Remplissez le pot avec de la terre

Den Pflanztrog mit Erde auffüllen

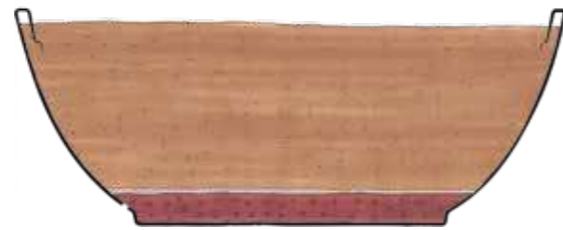

5.

Infine interra la pianta.

Eventually, place your plant in soil.

Enfin, enterrez la plante.

Nun die Pflanze einsetzen.

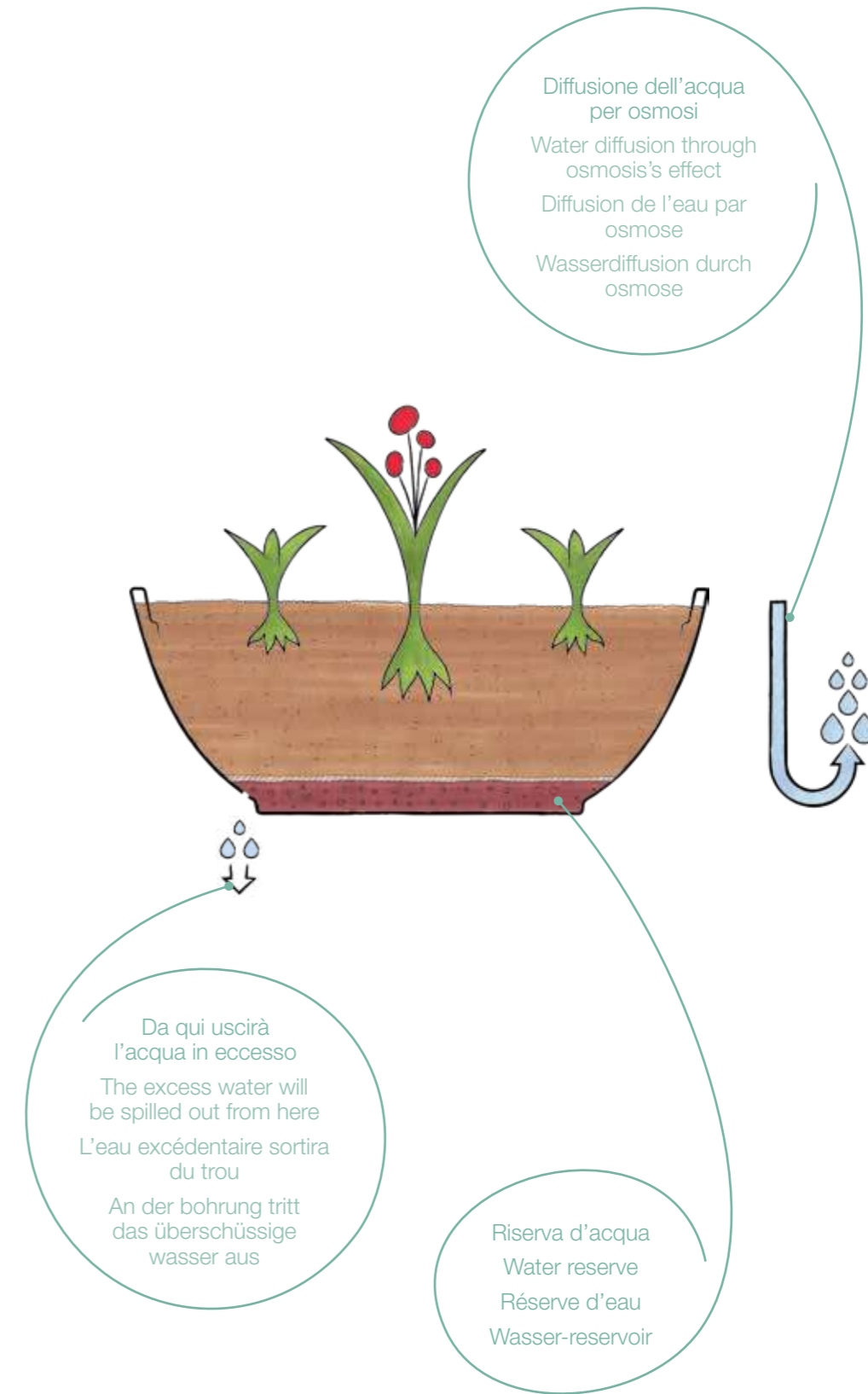

news
2018



043
bianco/white
blanc/weiß



201
cappuccino/cappuccino
cappuccino/cappuccino



235
beton/beton
beton/beton



032
antracite/anthracite
anthracite/anthrazitgrau



039
bronz/bronz
bronz/bronz

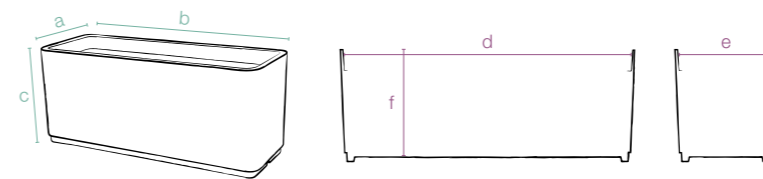

codice senza colore code without colour	Cm	dimensioni esterne external dimensions			dimensioni interne internal dimensions			litri liters	Confezione minima Minimum package	m ³	pezzi pallet pcs pallet	m ³
29 474 098	98	a38,2	b98,2	c39,8	d89	e29,5	f38,5	131	2 76x38,5x99h	0,29	10 80x120x210h	2,0



Indy

Vorresti arredare uno spazio senza l'utilizzo di piante? Con Indy Kit ti proponiamo un'ottima soluzione!

Would you like to decorate an area without using plants? With Indy Kit we suggest an excellent solution!

Souhaitez vous aménager un espace sans utiliser de plantes? Avec Indy Kit nous vous proposons une excellente solution!

Möchten Sie einen Bereich ohne Pflanzen arrangieren? Indy Kit ist die optimale Lösung!



Indy

Cod. 29 474 098



Griglia e Re-Pebbles™ =

Grid and Re-Pebbles™
Grille et Re-Pebbles™
Gitter und Re-Pebbles™

Cod. 10 923 098 000



Indy kit

Solo RE-PEBBLES™ Bianche
Only white RE-PEBBLES™
RE-PEBBLES™ Blanc seulement
Nur weiße RE-PEBBLES™

I rinforzi sono inclusi e vengono fissati ad incastro.

The brackets are included and are fitted into.

Die Distanzhalter sind eingeschlossen und mit Clip-Funktion zusammenbefestigt

Les espaceurs sont inclus et emboîtés



Creare una riserva d'acqua in pochi semplici passaggi:

How to create a water reserve in a few simple steps:

Comment créer une réserve d'eau en quelques étapes simples :

In wenigen einfachen Schritten einen Wasserspeicher anlegen:



1.

Con il trapano fai un foro sull'apposito rialzo
Use a drill to place a hole in the specific raised part of the pot

Utilisez une perceuse pour faire un trou sur l'augmentation appropriée

Mit der Bohrmaschine eine Bohrung an der entsprechenden Erhöhung ausführen



2.

Inserisci uno strato di argilla sul fondo

Add a layer of clay pebbles on the bottom

Ajouter une couche d'argile sur le fond

Eine Schicht Tongranulat am Boden einschichten



3.

Poi stendi il tessuto non tessuto

Then spread out the nonwoven fabric

Étirer le tissu non tissé

Dann das Vlies auslegen



4.

Riempi il vaso di terra

Fill the pot with topsoil

Remplissez le pot avec de la terre

Den Pflanztrog mit Erde auffüllen



5.

Infine interra la

Eventually, place

Enfin, enterrez

Nun die Pflanze



your plant in soil.

la plante.

einsetzen.



Da qui uscirà l'acqua in eccesso
The excess water will be spilled out from here
L'eau excédentaire sortira du trou

An der Bohrung tritt das überschüssige Wasser aus

news
2018



043
bianco/white
blanc/weiß



201
cappuccino/cappuccino
cappuccino/cappuccino



032
antracite/anthracite
anthracite/anthrazitgrau



039
bronzo/bronze
bronze/bronze



235
beton/beton
beton/beton

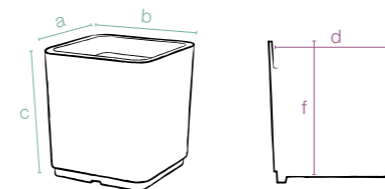

codice senza colore code without colour	Cm	dimensioni esterne external dimensions			dimensioni interne internal dimensions			litri liters	Confezione minima Minimum package	m ³	pezzi pallet pcs pallet	m ³
29 473 038	38	a38,2	b38,2	c39,8	d29,5	e29,5	f38,5	47	2 77x38,5x38,5h	0,11	12 80x120x95h	1,0

Creare una riserva d'acqua
in pochi semplici passaggi:
pagina 49

How to create a water reserve
in a few simple steps: page 49

Comment créer une réserve
d'eau en quelques étapes
simples: page 49

In wenigen einfachen Schritten
einen Wasserspeicher anlegen:
Seite 49



Pixel



Pixel

Cod. 29 473 038



Solo
RE-PEBBLES™
Bianche
Only white
RE-PEBBLES™
RE-PEBBLES™
Blanc seulement
Nur weiße RE-
PEBBLES™

Griglia e Re-Pebbles™ =

Grid and Re-Pebbles™
Grille et Re-Pebbles™
Gitter und Re-Pebbles™

Cod. 10 923 038 000



Pixel kit



Vorresti arredare uno spazio senza l'utilizzo di piante? Con Pixel Kit ti proponiamo un'ottima soluzione!

Would you like to decorate an area without using plants? With Pixel Kit we suggest an excellent solution!

Souhaitez vous aménager un espace sans utiliser de plantes? Avec Pixel Kit nous vous proposons une excellente solution!

Möchten Sie einen Bereich ohne Pflanzen arrangieren? Pixel Kit ist die optimale Lösung!

Groove family
componibile
modular
modulable
zusammensetzbar



Indy e Pixel si prestano molto bene per organizzare gli spazi

Indy and Pixel lend very well to organize spaces

Indy et Pixel se prêtent très bien pour l'organisation des espaces

Indy und Pixel sind ideal für die Organization der Räume

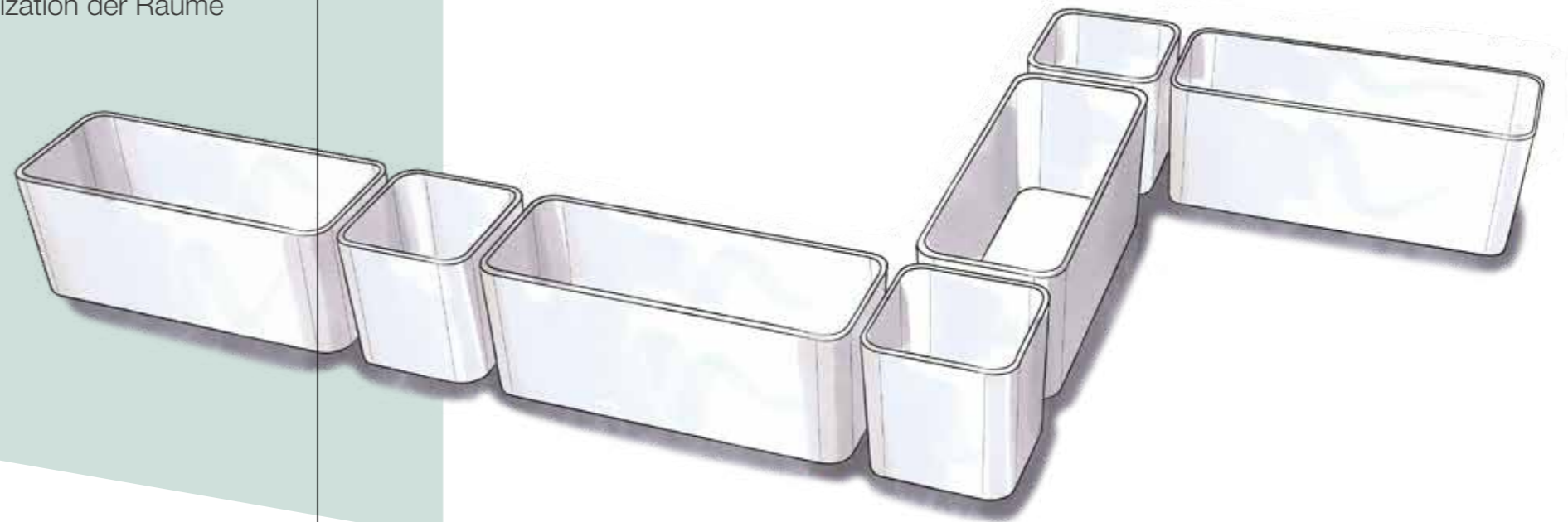
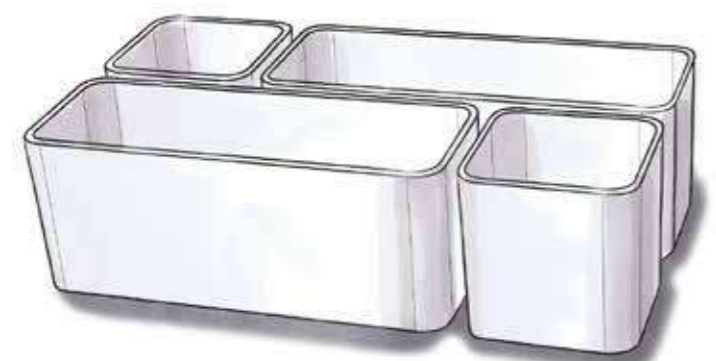

news
2018



043
bianco/white
blanc/weiß



201
cappuccino/cappuccino
cappuccino/cappuccino



235
beton/beton
beton/beton



032
antracite/anthracite
anthracite/anthrazitgrau



039
bronzo/bronze
bronze/bronze

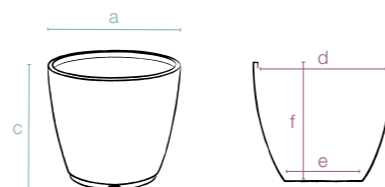

codice senza colore code without colour	Cm	dimensioni esterne external dimensions			dimensioni interne internal dimensions			litri liters	Confezione minima Minimum package	m ³	pezzi pallet pcs pallet	m ³
29 475 038	38	a38	b38	c32	d36	e24,5	f31,5	25	2 38x38x51h	0,074	42 80x120x115h	1,104
29 475 048	48	a48	b48	c40,5	d45,6	e31	f40	54	2 48x48x62h	0,143	45 80x120x230h	2,208
29 475 057	57	a57	b57	c48	d55,5	e37,5	f47,5	92	2 58x58x74h	0,249	24 80x120x230h	2,208



Ring



043
bianco/white
blanc/weiß



201
cappuccino/cappuccino
cappuccino/cappuccino



235
beton/beton
beton/beton



032
antracite/anthracite
anthracite/anthrazitgrau



039
bronzo/bronze
bronze/bronze

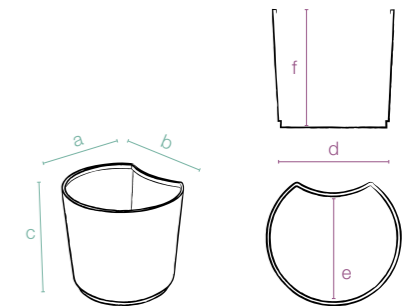

codice senza colore code without colour	Cm	dimensioni esterne external dimensions			dimensioni interne internal dimensions			litri liters	Confezione minima Minimum package	m ³	pezzi pallet pcs pallet	m ³
29 472 040	40	a41	b46,6	c39,8	d44,5	e35	f38,5	52	2 41x46,6x63h	0,11	44 80x120x230h	2,2
29 472 047	47	a46,3	b51,5	e47,2	d49	e41	f46	77	2 46,3x51,5x67h	0,16	40 100x115x224h	2,5
29 472 054	54	a51,4	b56,1	e54	d54	e45	f53	106	2 51,4x56,1x72,5h	0,2	36 100x115x218h	2,5

Urban SET 3 P.

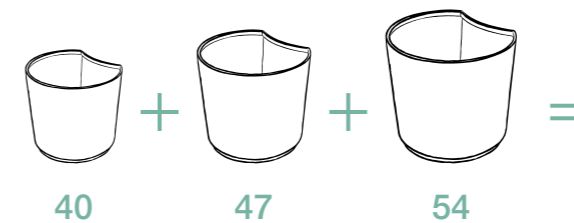

codice senza colore code without colour	Cm	dimensioni dimensions			Confezione minima Minimum package	m ³	pezzi pallet pcs pallet	m ³
14 999 002	40	a51,4	b56,1	e54	1 51,4x56,1x54h	0,15	16 100x120x204h	2,4



Urban

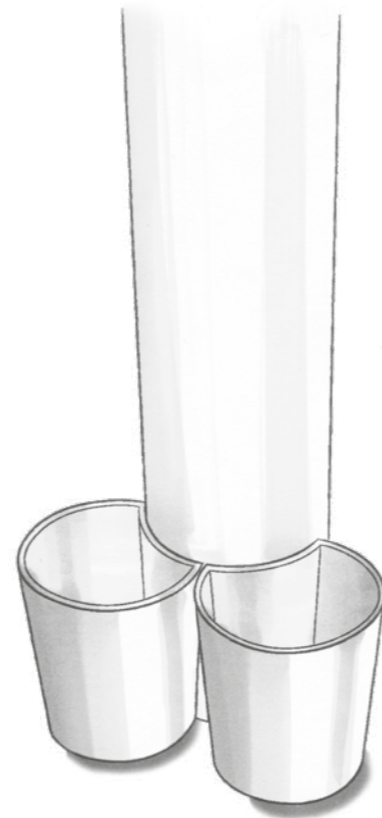

Urban family
componibile
modular
modulable
zusammensetzbar



Grazie ai diversi formati disponibili, Urban permette di creare tantissime composizioni e di modificarle con grande facilità.

With the different sizes of Urban you can create many compositions and modify them easily.

Les différentes mesures de l' Urban vous permettent de créer de nombreuses compositions et de les modifier facilement.

Mit den verschiedenen Größen des Urbans sind viele Zusammensetzungen möglich, die sich auch leicht ändern lassen.

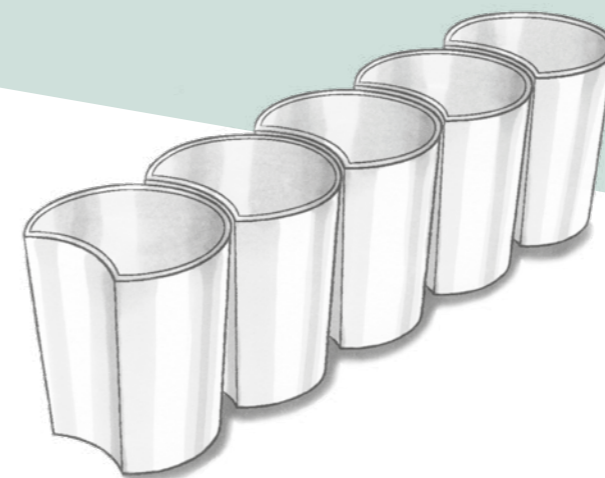



linea
ELEMENTS



Stem



Stalk

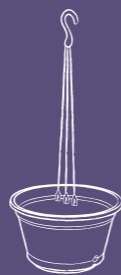

Air



Hydral



kit balcone
Hydral



Still

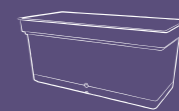

Aqua



Basilio

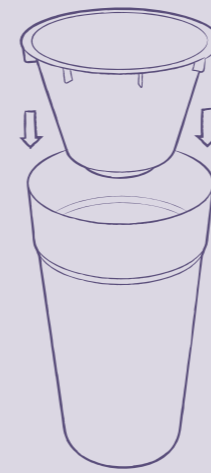

Riserva d'acqua
Water reserve
Réserve d'eau
Wasser-Reservoir

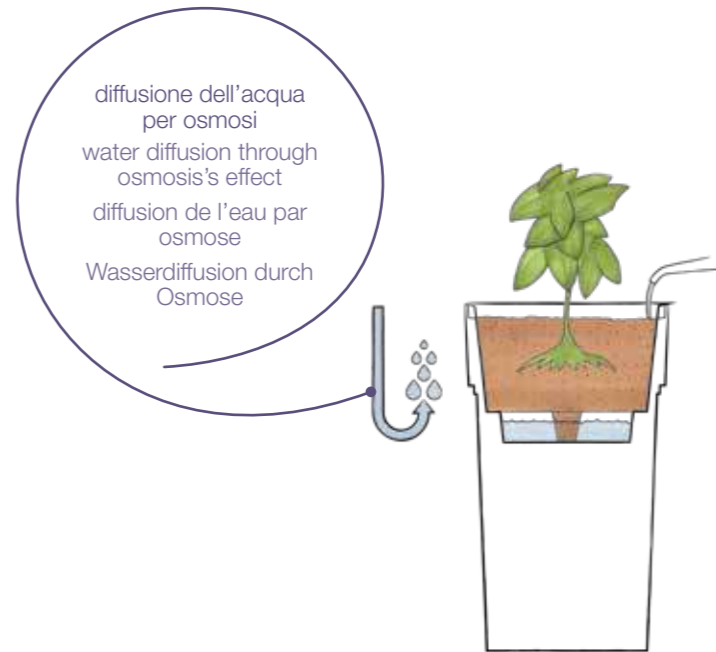

022
bianco/white
blanc/weiß



414
fog grey/ fog grey
brouillard gris/Nebel grau



406
bruno/brown
brun/braun



404
cedro/cedar
cèdre/zeder



005
antracite/anthracite
anthracite/anthrazitgrau



codice senza colore code without colour	Cm	dimensioni dimensions	litri liters	Confezione minima Minimum package	m ³	pezzi pallet pcs pallet	m ³
28 124 065	65	a38 b65	14	5 40x40x106h	0,17	60 80x120x229h	2,1
28 124 080	80	a38 b80	14	4 40x40x112h	0,18	48 80x120x240h	2,3



Stem

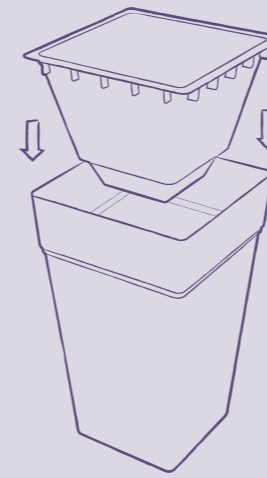

Riserva d'acqua
Water reserve
Réserve d'eau
Wasser-Reservoir

diffusione dell'acqua per osmosi
water diffusion through osmosis's effect
diffusion de l'eau par osmose
Wasserdiffusion durch Osmose

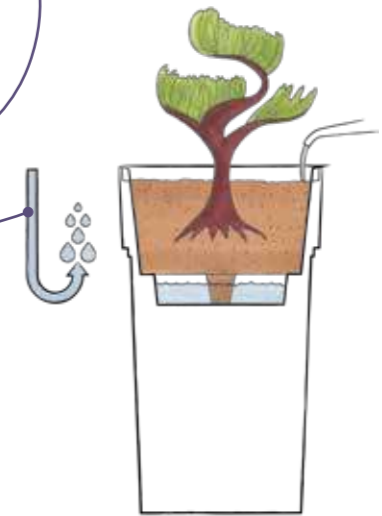

022
bianco/white
blanc/weiß



414
fog grey/ fog grey
brouillard gris/Nebel grau



406
bruno/brown
brun/braun

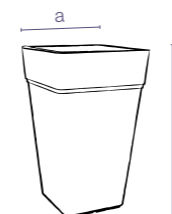

codice senza colore code without colour	Cm	dimensioni dimensions	litri liters	Confezione minima Minimum package	pezzi pallet pcs pallet	m ³
28 123 065	022 414 406	65	a38 b65 21	5 40x40x106h	0,17	60 80x120x229h 2,1
28 123 080	022 414 406	80	a38 b80 21	4 40x40x112h	0,18	48 80x120x240h 2,3



Stalk



404
cedro/cedar
cèdre/zeder



005
antracite/anthracite
anthracite/anthrazitgrau

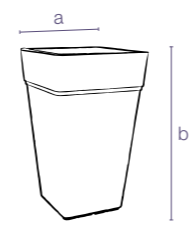

codice senza colore code without colour	Cm	litri liters	dimensioni dimensions	Confezione minima Minimum package	m ³	pezzi pallet pcs pallet	m ²
28 123 065	404 005 65	21	a38 b65	5 40x40x106h	0,17	60 80x120x229h	2,1
28 123 080	404 005 80	21	a38 b80	4 40x40x112h	0,18	48 80x120x240h	2,3



caratteristiche lampada: attacco E27, tensione max 220, potenza max 11 W, tipo risp. energ. standard

lamp characteristics: electrical coupling E27, max voltage 220, max electrical power 11 W, standard energy saving type lamp

caractéristiques de l'ampoule: culot E27, tension max 220, puissance max 11W, type économie d'énergie standard

charakteristik der Lampe E27 Fassung, max. 220 Volt max. 11 W. Energiesparlampe Typ Standard



codice senza colore code without colour	Cm	dimensioni dimensions	litri liters	Confezione minima Minimum package	m ³	pezzi pallet pcs pallet	m ³
32 124 065	65	a38 b65	14	2 40x40x106h	0,17	24 80x120x229h	2,1
32 124 080	80	a38 b80	14	2 40x40x112h	0,18	24 80x120x240h	2,3



codice senza colore code without colour	Cm	dimensioni dimensions	litri liters	Confezione minima Minimum package	m ³	pezzi pallet pcs pallet	m ³
32 123 065	65	a38 b65	21	2 40x40x106h	0,17	24 80x120x229h	2,1
32 123 080	80	a38 b80	21	2 40x40x112h	0,18	24 80x120x240h	2,3

Stem e Stalk luce





Gancio incluso
Hook included
Crochet Inclus
Einschließlich Haken

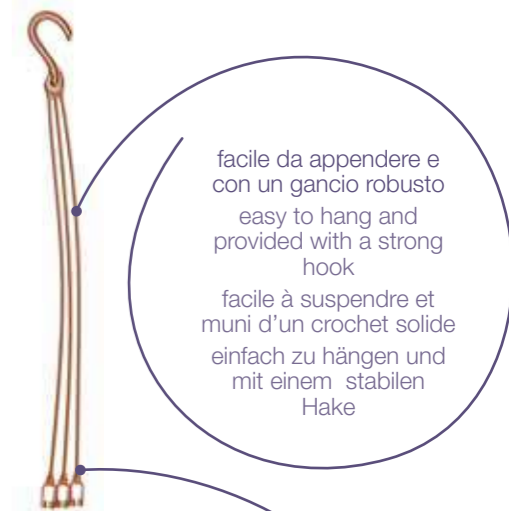

facile da appendere e con un gancio robusto
easy to hang and provided with a strong hook
facile à suspendre et muni d'un crochet solide
einfach zu hängen und mit einem stabilen Hake

codice: 03 308 050
I ganci sono disponibili anche sfusi in mazzetti da 12
Hooks are also available in packs with 12 pcs
Les crochets sont aussi disponibles dans emballages de 12 pièces
Die Haken sind los in VE von 12 Stk verfügbar



022
bianco/white
blanc/weiß



404
cedro/cedar
cèdre/zeder



406
bruno/brown
brun/braun



001
terracotta/terracotta colour
couleur terre/farbe terrakotta



005
antracite/anthracite
anthracite/anthrazitgrau



codice senza colore code without colour	Cm	dimensioni dimensions	litri liters	Confezione minima Minimum package	m ³	pezzi pallet pcs pallet	m ³
28 125 029 022 404 406 001 005	65	a28,8 b16,3	6,3	12 31x31x42h	0,04	264 80x115x115h	1,058



Air

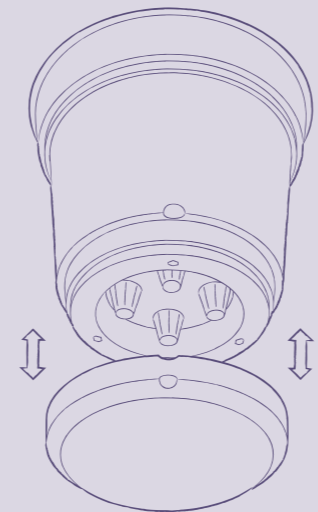

Il sottovaso è incluso e viene fissato ad incastro.
 The saucer is included and is fitted into.
 La soucoupe est inclus et est emboîtée dans.
 Der Untersetzer ist eingeschlossen und mit Clip-Funktion zusammengesteckt.

diffusione dell'acqua per osmosi
 water diffusion through osmosis's effect
 diffusion de l'eau par osmose
 Wasserdiffusion durch Osmose

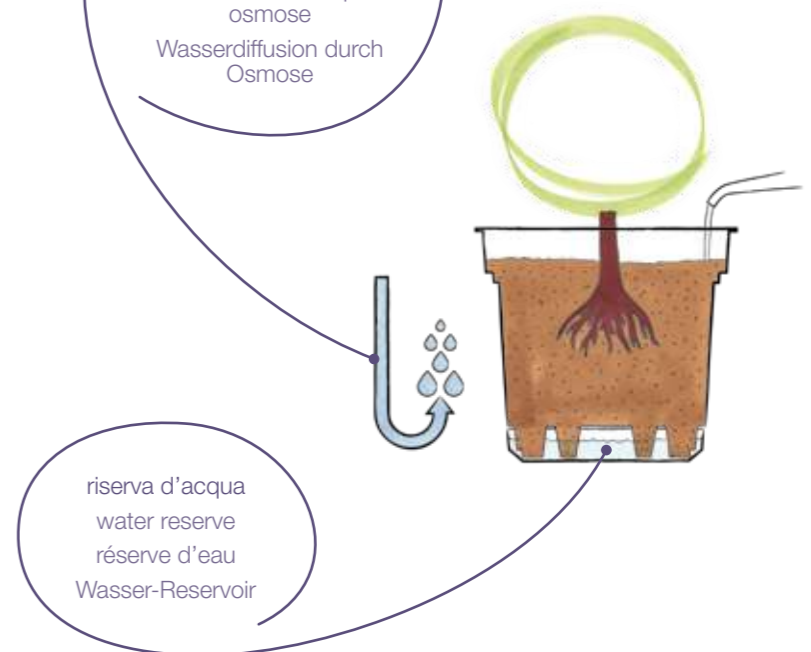

riserva d'acqua
 water reserve
 réserve d'eau
 Wasser-Reservoir



005
 antracite/anthracite
 anthracite/anthrazitgrau

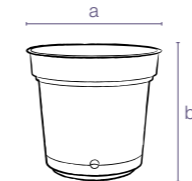

codice senza colore code without colour	Cm	dimensioni dimensions	litri liters	Confezione minima Minimum package	pezzi pallet pcs pallet	m ³
28 107 018	18	a18 b16	2,5	20 18x18x33h	960	0,008
28 107 023	23	a23 b21	5	10 23x23x43h	540	0,030
28 107 028	28	a28 b25	9,3	10 28x28x48h	330	0,030
28 107 033	33	a33 b30	15,3	10 33x33x43h	140	0,037
28 107 038	38	a38 b34	23	8 38x38x68h	96	0,077
28 107 048	48	a48 b43	46,5	4 48x48x58h	144	0,105
28 107 058	58	a58 b48	77	4 58x58x68h	96	0,180
28 107 068	68	a68 b55	120	2 68x68x60h	26	0,218
28 107 078	78	a78 b61	175,5	2 78x78x65h	22	0,310

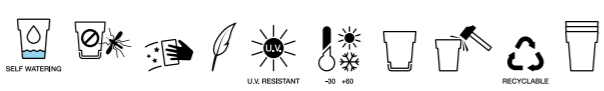

Hydral

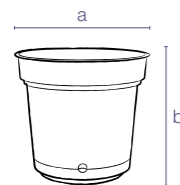

codice senza colore code without colour	Cm	dimensioni dimensions	litri liters	Confezione minima Minimum package	m ³	pezzi pallet pcs pallet	m ³
28 107 018	18	a18 b16	2,5	20 18x18x33h	0,008	960 80x115x115h	1,06
28 107 023	23	a23 b21	5	10 23x23x43h	0,030	540 80x115x115h	1,06
28 107 028	28	a28 b25	9,3	10 28x28x48h	0,030	330 80x115x115h	1,06
28 107 033	33	a33 b30	15,3	10 33x33x43h	0,037	140 80x120x120h	1,32
28 107 038	38	a38 b34	23	8 38x38x68h	0,077	96 80x115x115h	1,06
28 107 048	48	a48 b43	46,5	4 48x48x58h	0,105	144 100x115x230h	2,65
28 107 058	58	a58 b48	77	4 58x58x68h	0,180	96 100x115x220h	2,12
28 107 068	68	a68 b55	120	2 68x68x60h	0,218	26 78x78x230h	1,40
28 107 078	78	a78 b61	175,5	2 78x78x65h	0,310	22 78x78x230h	1,40



404
cedro/cedar
cèdre/zeder



022
bianco/white
blanc/weiß

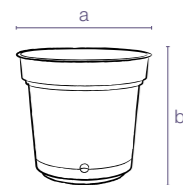

codice senza colore code without colour	Cm	dimensioni dimensions	litri liters	Confezione minima Minimum package	m³	pezzi pallet pcs pallet	m³
28 107 018	18	a18 b16	2,5	20 18x18x33h	0,008	960	80x115x115h 1,06
28 107 023	23	a23 b21	5	10 23x23x43h	0,030	540	80x115x115h 1,06
28 107 028	28	a28 b25	9,3	10 28x28x48h	0,030	330	80x115x115h 1,06
28 107 033	33	a33 b30	15,3	10 33x33x43h	0,037	140	80x120x120h 1,32
28 107 038	38	a38 b34	23	8 38x38x68h	0,077	96	80x115x115h 1,06
28 107 048	48	a48 b43	46,5	4 48x48x58h	0,105	144	100x115x230h 2,65
28 107 058	58	a58 b48	77	4 58x58x68h	0,180	96	100x115x220h 2,12
28 107 068	68	a68 b55	120	2 68x68x60h	0,218	26	78x78x230h 1,40
28 107 078	78	a78 b61	175,5	2 78x78x65h	0,310	22	78x78x230h 1,40



416
marsala/marsala
marsala /marsala



415
terra di Siena/terra di siena
terra di siena/terra di siena



“Cercavo un vaso di buone dimensioni dove trapiantare i pomodori. Il materiale è resistente ed è comodo il sottovaso integrato. Consiglio di mettere dell'argilla espansa sul fondo per migliorare il drenaggio dell'acqua in eccesso.”

“I was looking for a pot with good dimensions to transplant the tomatoes. The material is resistant and the integrated saucer is smart. My advice is to fill the pot with some clay pebbles to improve the drainage of the excess water.”

“Ich suchte einen großen Topf um Tomaten zu pflanzen. Das Material ist hier beständig und der integrierte Untersetzer ist praktisch. Für eine gute Drainage empfehle ich den Topfboden mit einer Blähton-schicht zu füllen.”

“Je cherchais un grand pot pour planter des tomates. Là le matériel est durable et la soucoupe intégrée est pratique. Pour le drainage de l'eau en excès je conseille de mettre de l'argile expansée sur le fond du pot.”

Sara



414
fog grey/ fog grey
brouillard gris/Nebel grau



406
bruno/brown
brun/braun

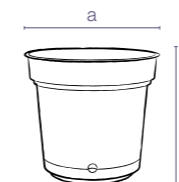

codice senza colore code without colour	Cm	dimensioni dimensions	litri liters	Confezione minima Minimum package	m ³	pezzi pallet pcs pallet	m ³
28 107 018	18	a18 b16	2,5	20 18x18x33h	0,008	960 80x115x115h	1,06
28 107 023	23	a23 b21	5	10 23x23x43h	0,030	540 80x115x115h	1,06
28 107 028	28	a28 b25	9,3	10 28x28x48h	0,030	330 80x115x115h	1,06
28 107 033	33	a33 b30	15,3	10 33x33x43h	0,037	140 80x120x120h	1,32
28 107 038	38	a38 b34	23	8 38x38x68h	0,077	96 80x115x115h	1,06
28 107 048	48	a48 b43	46,5	4 48x48x58h	0,105	144 100x115x230h	2,65
28 107 058	58	a58 b48	77	4 58x58x68h	0,180	96 100x115x220h	2,12
28 107 068	68	a68 b55	120	2 68x68x60h	0,218	26 78x78x230h	1,40
28 107 078	78	a78 b61	175,5	2 78x78x65h	0,310	22 78x78x230h	1,40

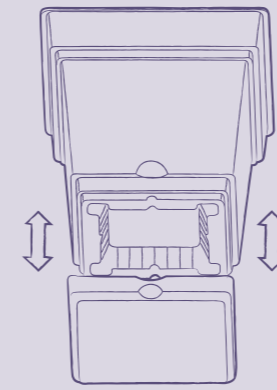

Il sottovaso è incluso e viene fissato ad incastro.
The saucer is included and is fitted into.
La soucoupe est inclus et est emboîtée dans.
Der Untersetzer ist eingeschlossen und mit Clip-Funktion zusammengesteckt.

diffusione dell'acqua per osmosi
water diffusion through osmosis's effect
diffusion de l'eau par osmose
Wasserdiffusion durch Osmose

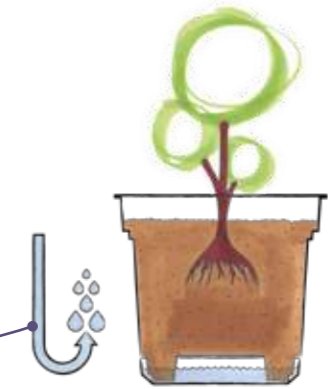

022
bianco/white
blanc/weiß



414
fog grey/ fog grey
brouillard gris/Nebel grau



415
terra di Siena/terra di siena
terra di siena/terra di siena



406
bruno/brown
brun/braun



416
marsala/marsala
marsala /marsala



404
cedro/cedar
cèdre/zeder



005
antracite/anthracite
anthracite/anthrazitgrau

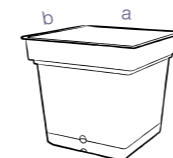

codice senza colore code without colour		Cm	dimensioni dimensions	litri liters	Confezione minima Minimum package	pezzi pallet pcs pallet	pezzi pallet pcs pallet	m³
28 111 038	022 414 415 406 416 404 005	38	a38 b38 c38	29	4 38x38x47h	0,068	96 80x115x115h	1,06
28 111 047	022 414 415 406 416 404 005	47	a47 b47 c43	55	4 47x47x59h	0,130	128 100x115x230h	2,65



Still

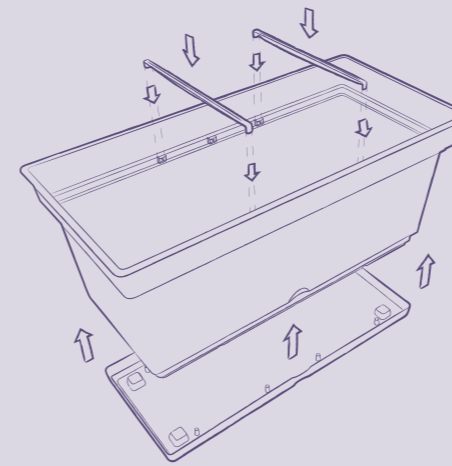

Il sottovaso e i distanziali sono inclusi e vengono fissati ad incastro.

The saucer and the brackets are included and are fitted into.

Der Untersetzer und die Distanzhalter sind eingeschlossen und mit Clip-Funktion zusammenbefestigt

La soucoupe et les espaceurs sont inclus et emboîtés

diffusione dell'acqua per osmosi
 water diffusion through osmosis's effect
 diffusion de l'eau par osmose
 Wasserdiffusion durch Osmose

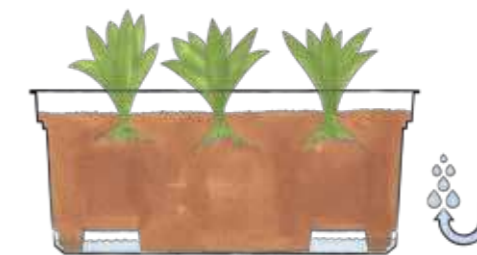

022
 bianco/white
 blanc/weiß



414
 fog grey/ fog grey
 brouillard gris/Nebel grau



415
 terra di Siena/terra di siena
 terra di siena/terra di siena



406
 bruno/brown
 brun/braun



416
 marsala/marsala
 marsala /marsala



404
 cedro/cedar
 cèdre/zeder



005
 antracite/anthracite
 anthracite/anthrazitgrau

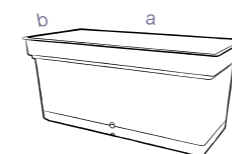

codice senza colore
 code without colour

28 109 078 022 414 415 406 416 404 005

28 109 098 022 414 415 406 416 404 005

Cm

dimensioni

a78 b38 c38 66

a99 b47 c47 130

litri

66

130

Confezione minima

Minimum package

4 78x38x47h

4 98x47x59h

m³

0,139

0,272

pezzi pallet

pcs pallet

120 80x115x230h

64 100x115x230

m³

2,12

2,65



Aqua



grow
your own
veggies
at home!

Crea il tuo orto urbano abbinando il supporto Basilio ai vasi Aqua e Still

Create your urban garden combining the support Basilio with the pots Aqua and Still
Créez votre potager en hauteur avec le support Basilio et les pot Aqua et Still
Bau dein Hochbeet mit der Halterung Basilio und den Töpfen Aqua und Still

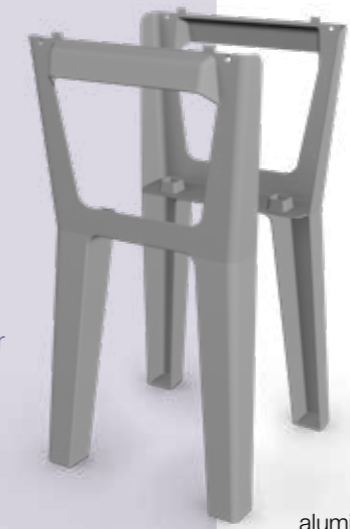

Design by:
favaretto/partners

417
aluminium/aluminium
aluminium/aluminium

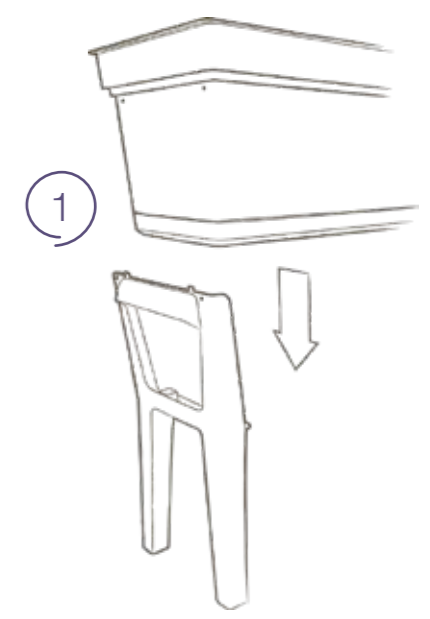

Still cm 38
pagina 82



Aqua cm 78
pagina 84

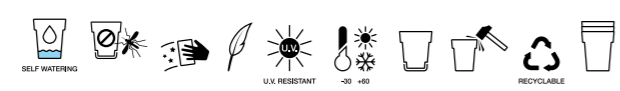
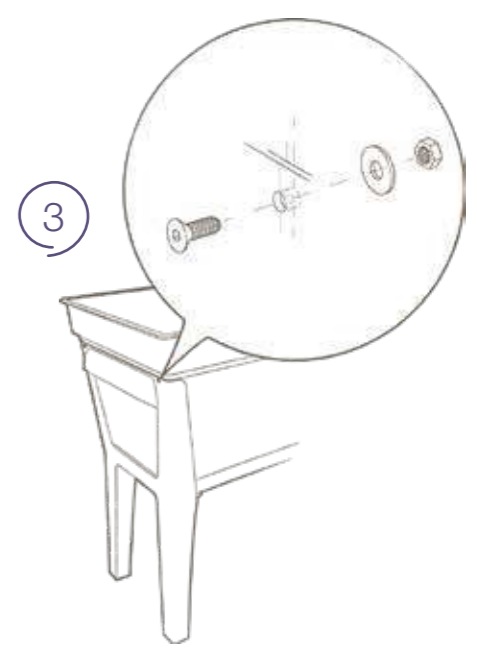
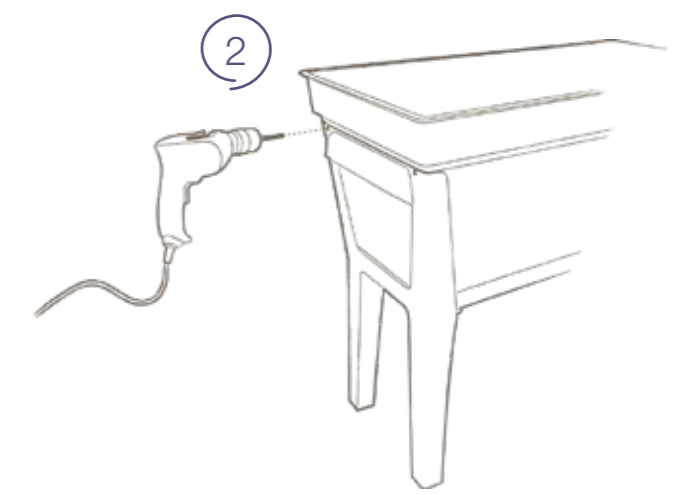

Basilio

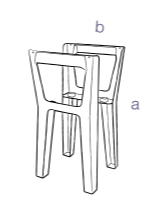

codice senza colore code without colour	Cm	dimensioni dimensions	Confezione minima Minimum package	pezzi pallet pcs pallet
28 113 061	61	a61 b32	62x33x25h	39 80x120x224h

Consigli utili

Basilio permette di prendervi cura delle vostre piante, fiori e ortaggi più comodamente.

- La scelta del terriccio è determinante per il successo del tuo orto, fatti consigliare dal rivenditore locale o l'agricoltore vicino.
- Scegli il posto giusto per il tuo basilio, considerando che l'esposizione a sud è quella ottimale.
- Semina seguendo le indicazioni di spazio e profondità indicate sulla confezione dei semi, oppure scegli delle piantine già cresciute per semplificare il lavoro.
- Annaffia le piante al tramonto o al mattino presto.
- Alcuni ortaggi producono di più se vengono raccolti spesso come fagioli, zucchine, peperoni e cetrioli.

Useful advice

Basilio allows to look after of your plants, flowers and veggies more easily.

- Soil is essential for the success of your urban garden; ask the retailer or the nearby agriculturist for a suggestion.
- Choose the best place for your Basilio, considering that facing south is the best position.
- Sow following the advice indicated on the packaging, or choose the seedlings to simplify the work.
- Water the plants at sunset or early in the morning.
- Some vegetables as beans, zucchini, peppers and cucumbers are more productive if they are harvested often.



Empfehlungen

Basilio macht Ihre Pflege für Pflanzen, Blumen und Gemüse bequemer.

- Die richtige Gartenerde ist für den Erfolg Ihres Hochbeetes grundsätzlich, lassen Sie sich von Ihrem Fachhändler beraten.
- Wählen Sie für Ihr Basilio den richtigen Standort. Eine Ausrichtung nach Süden wäre optimal.
- Beachten Sie bei der Aussaat den Abstand und die Tiefe die auf den Samentütchen angegeben sind. Um die Arbeit zu vereinfachen können Sie auch vorkultivierte Pflanzen wählen.
- Begießen Sie die Pflanzen abends oder am frühen Morgen.
- Einige Gemüse, wie z.B. Bohnen, Zucchini, Paprika und Gurken, erzeugen mehr, wenn man sie häufig erntet.

Conseils

Basilio peut prendre soin de vos plantes, vos fleurs et vos légumes plus facilement.

- Le choix de la terre est décisif pour le succès de votre potager, faites-vous conseiller par votre commerçant ou par l'agriculteur local.
- Choisissez la bonne place pour votre Basilio, considérant que l'exposition au sud est optimale.
- Semez en suivant les indications de distance et profondeur indiquées sur l'emballage des graines ou choisissez les plants déjà développés afin de simplifier le travail.
- Arrosez les plantes le soir ou tôt le matin.
- Certains légumes produisent plus s'ils sont cueillis souvent comme les haricots, les courgettes, les poivrons et les concombres.





kit balcone Hydral



022
bianco/white
blanc/weiß



414
fog grey/ fog grey
brouillard gris/Nebel grau



415
terra di Siena/terra di siena
terra di siena/terra di siena



406
bruno/brown
brun/braun



416
marsala/marsala
marsala /marsala



404
cedro/cedar
cèdre/zeder



005
antracite/anthracite
anthracite/anthrazitgrau

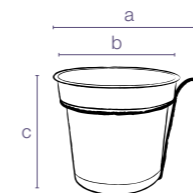

codice senza colore code without colour	Cm	dimensioni dimensions	pezzi pallet pcs pallet	m ³
28 130 023	23	a30 b23 c22	15 60x40x52h	0,13
			88 60x80x115h	0,55



linea
CLEAR



Plato Quadro



Orchidea



Porto



Plato



Madeira



Coimbra



Algarve



Orchidea
pagina 114



Plato Quadro
Pagina 116



Plato
pagina 118



disponibile nelle
misure 14 e 16
on the measures
14 and 16
dans les mesures
14 et 16
in den Größen
14 - 16

Porto
pagina 124



Madeira
pagina 132



Coimbra
pagina 136



Algarve
pagina 128



linea
PASTEL



Madeira



Estoril



Santiago



Superficie lucida
Glossy surface
Surface brillante
Glänzende Oberfläche



Madeira pastel



412
acquamarina/aquamarine
aigue-marine/aquamarin



410
ghiaccio/ice
glace/eis



409
malva/mauve
mauve/mauve



411
porcellana/porcelain
porcelaine/porzellan

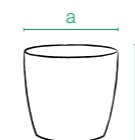

codice senza colore code without colour	Cm	dimensioni dimensions	litri liters	Confezione minima Minimum package	m³	pezzi pallet pcs pallet	m³
27 035 011	11	a11 b10	0,7	18 17x33x33h	0,01	756	80x120x115h 1,10
27 035 014	14	a14 b12,2	1,4	18 43x29x23h	0,02	972	80x120x225h 2,16
27 035 018	18	a18 b16,2	3,3	12 57x38x23h	0,05	432	80x120x225h 2,16
27 035 022	22	a22 b19,8	6,2	8 46x24x41h	0,04	240	80x120x220h 2,11

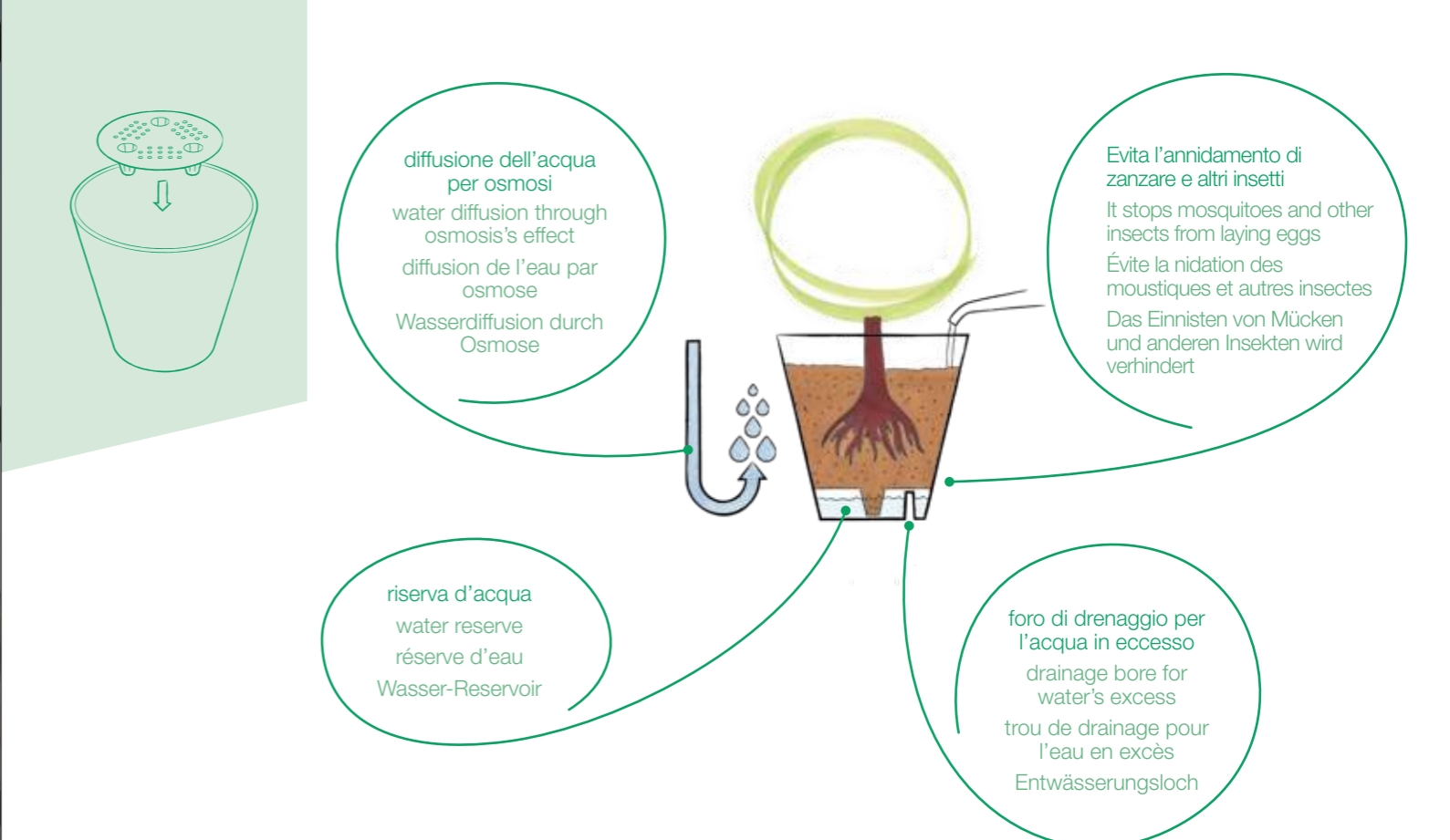

412
acquamarina/aquamarine
aigue-marine/aquamarin



410
ghiaccio/ice
glace/eis



409
malva/mauve
mauve/mauve



411
porcellana/porcelain
porcelaine/porzellan

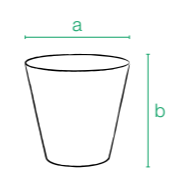

codice senza colore code without colour	Cm	dimensioni dimensions	litri liters	Confezione minima Minimum package	m ³	pezzi pallet pcs pallet	m ³
27 037 016	16	a16 b15	1,6	12 17x33x31h	0,01	1176 80x120x230h	2,2
27 037 020	20	a20 b19	3,2	8 21x21x40h	0,01	800 80x120x215h	2,1
27 037 025	25	a25 b23,5	6,2	6 26x26x44h	0,03	360 80x120x235h	2,2
27 037 030	30	a30 b28	11,8	4 31x31x39h	0,03	160 80x120x210h	2,0

Superficie lucida
Glossy surface
Surface brillante
Glänzende Oberfläche

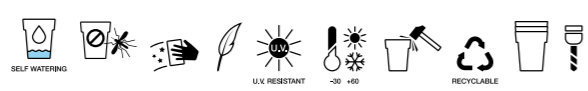

Estoril

water reserve
pastel



ideale come porta vaso
 ideal as cachepot
 idéal comme pot de fleurs
 ideal als Übertopf

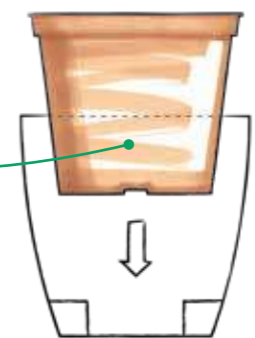

Linea Flortec
 pagina 189



412
 acquamarina/aquamarine
 algue-marine/aquamarin



410
 ghiaccio/ice
 glace/eis



409
 malva/mauve
 mauve/mauve



411
 porcellana/porcelain
 porcelaine/porzellan

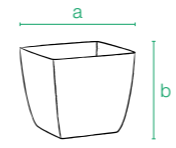

codice senza colore code without colour	Cm	dimensioni dimensions	litri liters	Confezione minima Minimum package	m ³	pezzi pallet pcs pallet	m ²
27 100 011	11	a11 b10	1	18 13x35x24h	0,01	2916 80x120x231h	2,22
27 100 013	13	a13 b12	1,5	18 15x28x36h	0,01	2160 80x120x231h	2,22
27 100 015	15	a15 b14,5	2,5	12 17x33x31h	0,01	1176 80x120x230h	2,21
27 100 020	20	a19 b17	5	8 21x21x40h	0,01	800 80x120x215h	2,06

Superficie lucida
 Glossy surface
 Surface brillante
 Glänzende Oberfläche



Santiago
 pastel



linea
COLOUR



Sunrise



Orchidea



Plato Quadro



Plato



Santiago



Estoril



Porto



Algarve



Madeira



Coimbra

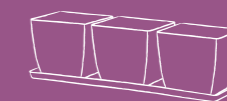

Trio Santiago



Trio Madeira



022
bianco/white
blanc/weiß



401
peonia/peony
pivoine/pfingstrose



402
lilyum/lilyum
lilyum/lilyum



404
cedro/cedar
cèdre/zeder



406
bruno/brown
brun/braun



disponibile anche nella versione con il Madeira
also available with Madeira pots
disponible aussi avec le pots Madeira
auch mit Madeiratöpfe erhältlich

Superficie lucida
Glossy surface
Surface brillante
Glänzende Oberfläche

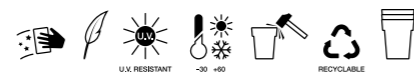

Trio

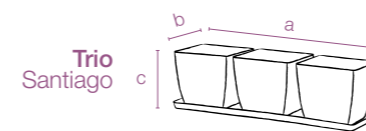

Trio Santiago

codice senza colore code without colour	Cm	dimensioni dimensions	Confezione minima Minimum package	pezzi pallet pcs pallet	m ³
08 126 035	35	a35 b11 c0,1	10 57x38x23h	0,05	200 80x120x130h 1,25

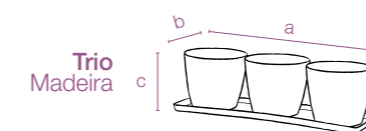

Trio Madeira

codice senza colore code without colour	Cm	dimensioni dimensions	Confezione minima Minimum package	pezzi pallet pcs pallet	m ³
08 129 035	35	a35 b11 c0,1	10 57x38x23h	0,05	200 80x120x130h 1,25



Superficie lucida
Glossy surface
Surface brillante
Glänzende Oberfläche



Sunrise



022
bianco/white
blanc/weiß



401
peonia/peony
pivoine/pfingstrose



402
lilyum/lilyum
lilyum/lilyum



404
cedro/cedar
cèdre/zeder



406
bruno/brown
brun/braun



006
nero/black
noir/schwarz



codice senza colore code without colour	Cm	dimensioni dimensions	litri liters	Confezione minima Minimum package	m ³	pezzi pallet pcs pallet	m ³
08 119 036	36	a35,8 b14,1	5	12 57x38x23h	0,05	432 80x120x225h	2,16



Superficie lucida
Glossy surface
Surface brillante
Glänzende Oberfläche



Orchidea



024
trasparente/transparent
transparent/transparent



022
bianco/white
blanc/weiß



401
peonia/peony
pivoine/pfingstrose



402
lilyum/lilyum
lilyum/lilyum



404
cedro/cedar
cèdre/zeder



406
bruno/brown
brun/braun

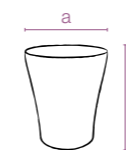

codice senza colore code without colour	Cm	dimensioni dimensions	litri liters	Confezione minima Minimum package	m ³	pezzi pallet pcs pallet	m ³
08 120 014	14	a12,5 b15,8	1,3	12 29x15x36h	0,015	612 80x120x115	1,1
08 120 016	16	a15,7 b18,6	2,2	12 32,5x17x35,5h	0,019	504 80x120x115	1,1



discreto ed elegante, Plato Quadro si abbina a qualsiasi tipo di vaso, anche in terracotta

discreet and elegant, Plato Quadro combines with different types of pots, also with the ones made of terracotta

discret et élégant, Plato Quadro se combine avec différents types de pots, aussi celles en terre cuite

diskret und stilvoll, Plato Quadro passt zu verschiedenen Topfarten, auch aus Terrakotta.



024
trasparente/transparent
transparent/transparent

ideale anche come svuota tasche o porta oggetti da scrivania

Also ideal as empties pockets or holding objects by desk

Aussi idéal comme conteneur ou porte-objets au bureau

Ideal auch als Ablageschale und für den Schreibtisch

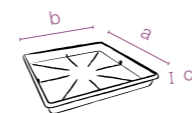

codice senza colore code without colour	Cm	dimensioni dimensions	Confezione minima Minimum package	m ³	Confezione minima Minimum package	m ³	pezzi pallet pcs pallet	m ³
08 122 027	27	a27 b27 c4	4 27x27x9h	0,01	50 58X29X41h	0,07	400 80x120x100h	1,15
08 122 033	33	a33 b33 c4,2	4 33x33x9,5h	0,01	20 34X34X41h	0,05	240 80x120x100h	1,15
08 122 038	38	a38 b38 c4,5	4 38x38x10h	0,01	20 39X39X41h	0,06	240 80x120x100h	1,15

Superficie lucida
Glossy surface
Surface brillante
Glänzende Oberfläche



Plato quadro



024
trasparente/transparent
transparent/transparent



022
bianco/white
blanc/weiß



010
rosso/red
rouge/rot



401
peonia/peony
pivoine/pfingstrose



402
lilyum/lilyum
lilyum/lilyum



028
turchese/turquoise
turquoise/türkis



404
cedro/cedar
cèdre/zeder



407
salvia/sage
sauge/salbei



406
bruno/brown
brun/braun



006
nero/black
noir/schwarz

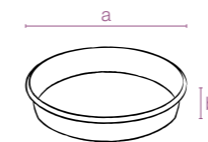

codice senza colore code without colour	Cm	dimensioni dimensions	Confezione minima Minimum package	m ³	pezzi pallet pcs pallet	m ³
08 086 012	12	a 12 b 2	18 12x12x12h	0,002	828	60x40x50h 0,12
08 086 014	14	a 14 b 2,3	18 14x14x12h	0,002	648	60x40x50h 0,12
08 086 016	16	a 16 b 2,7	12 16x16x12h	0,003	360	60x40x50h 0,12
08 086 020	20	a 20 b 3,3	8 20x20x12h	0,005	240	60x40x50h 0,12
08 086 024	24	a 24 b 4	6 24x24x12h	0,007	90	60x40x50h 0,12
08 086 028	28	a 28 b 4,7	4 28x28x12h	0,009	64	60x40x50h 0,12
08 086 032	32	a 32 b 5,2	2 32x32x8h	0,008	32	60x40x50h 0,12
08 086 036	36	a 36 b 5,2	2 36x36x8h	0,010	32	60x40x50h 0,12



Superficie lucida
Glossy surface
Surface brillante
Glänzende Oberfläche



Plato



ideale come porta vaso
 ideal as cachepot
 idéal comme pot de fleurs
 ideal als Übertopf

Linea Flortec
 pagina 189

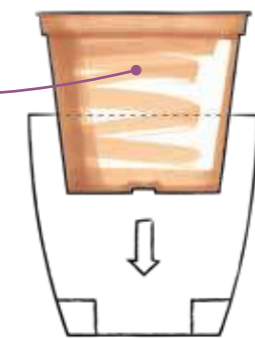

022
 bianco/white
 blanc/weiß



401
 peonia/peony
 pivoine/pfingstrose



402
 lilyum/lilyum
 lilyum/lilyum



028
 turchese/turquoise
 turquoise/türkis



404
 cedro/cedar
 cèdre/zeder



407
 salvia/sage
 sauge/salbei



406
 bruno/brown
 brun/braun



006
 nero/black
 noir/schwarz

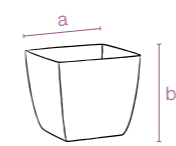

codice senza colore code without colour	Cm	dimensioni dimensions	litri liters	Confezione minima Minimum package	pezzi pallet pcs pallet	m ³
08 100 011	11	a 11 b 10	1	18 13x35x24h	0,01	2916 80x120x231h 2,22
08 100 013	13	a 13 b 12	1,5	18 15x28x36h	0,01	2160 80x120x231h 2,22
08 100 015	15	a 15 b 14,5	2,5	12 17x33x31h	0,01	1176 80x120x230h 2,21
08 100 020	20	a 19 b 17	5	8 21x21x40h	0,01	800 80x120x215h 2,06

Superficie lucida
 Glossy surface
 Surface brillante
 Glänzende Oberfläche

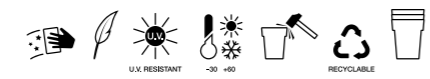

Santiago

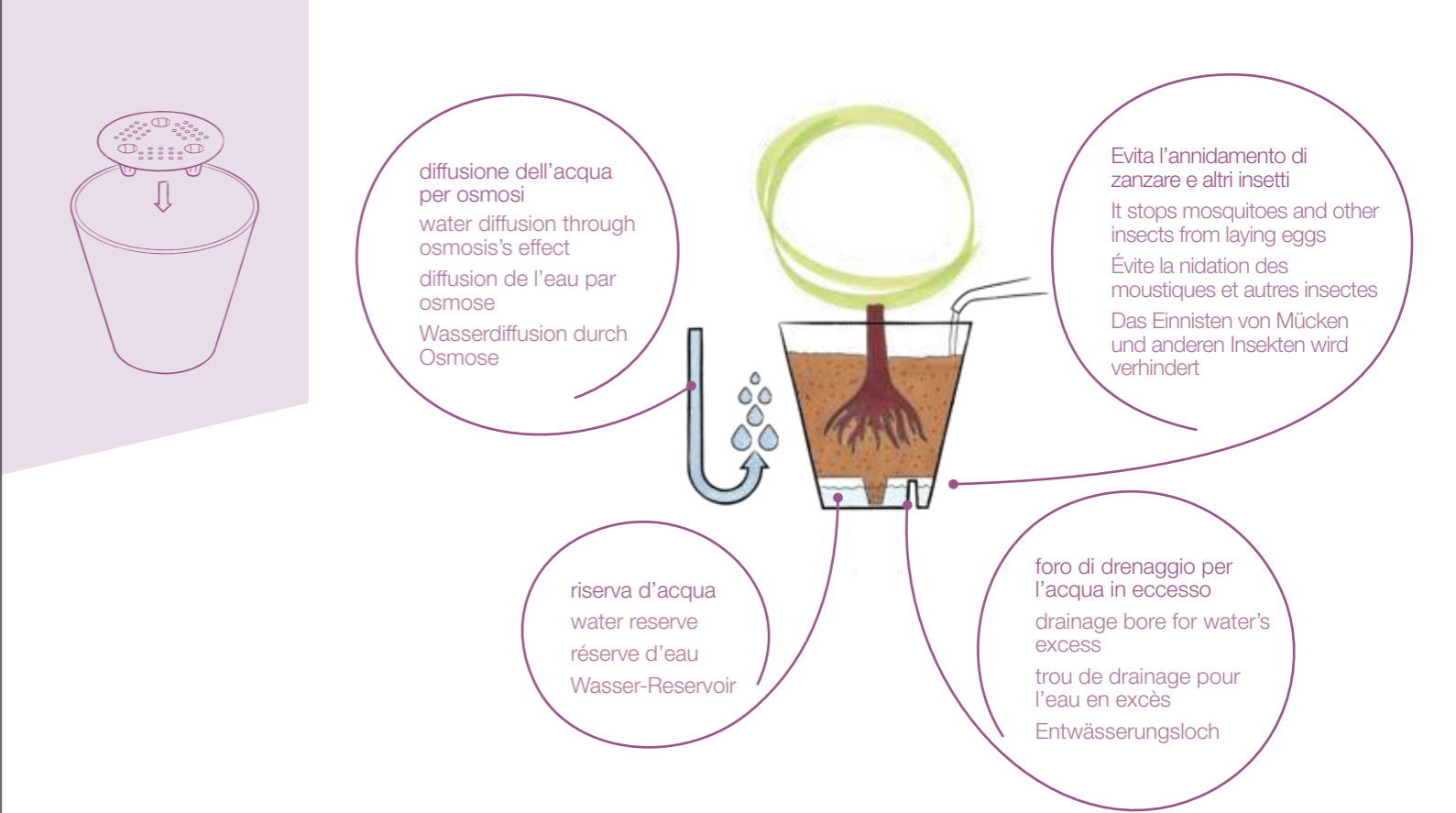

022
bianco/white
blanc/weiß



401
peonia/peony
pivoine/pfingstrose



402
lilyum/lilyum
lilyum/lilyum



028
turchese/turquoise
turquoise/türkis



404
cedro/cedar
cèdre/zeder



407
salvia/sage
saugé/salbei



406
bruno/brown
brun/braun



006
nero/black
noir/schwarz



Plato
pagina 118

Superficie lucida
Glossy surface
Surface brillante
Glänzende Oberfläche



Estoril

water reserve

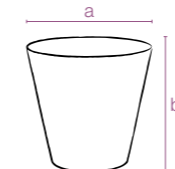

codice senza colore code without colour	Cm	dimensioni dimensions	litri liters		Confezione minima Minimum package	m ³	pezzi pallet pcs pallet	m ³
08 037 016	16	a16 b15	1,6	14	12 17x33x31h	0,01	1176 80x120x230h	2,2
08 037 020	20	a20 b19	3,2	16	8 21x21x40h	0,01	800 80x120x215h	2,1
08 037 025	25	a25 b23,5	6,2	20	6 26x26x44h	0,03	360 80x120x235h	2,2
08 037 030	30	a30 b28	11,8	24	4 31x31x39h	0,03	160 80x120x210h	2,0



024
trasparente/transparent
transparent/transparent



022
bianco/white
blanc/weiß



406
bruno/brown
brun/braun



010
rosso/red
rouge/rot



401
peonia/peony
pivoine/pfingstrose



402
lilyum/lilyum
lilyum/lilyum



404
cedro/cedar
cèdre/zeder



407
salvia/sage
saugé/salbei



006
nero/black
noir/schwarz



Plato
pagina 118



Superficie lucida
Glossy surface
Surface brillante
Glänzende Oberfläche



Porto

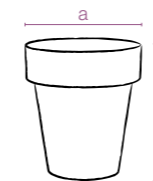

codice senza colore code without colour	Cm	dimensioni dimensions	litri liters	Confezione minima Minimum package	m ³	pezzi pallet pcs pallet	m ³			
08 083 014	14	a 14 b 15	1,3	12	18	43x15x40h	0,02	380	80x60x115h	0,55
08 083 016	16	a 16 b 17,5	2,0	14	18	50x16x41h	0,03	270	80x60x115h	0,55
08 083 020	20	a 20 b 21,5	4,0	16	12	41x21x50h	0,05	154	80x60x115h	0,55
08 083 025	25	a 25 b 27	8,0	20	8	51x26x50h	0,06	66	80x60x115h	0,55
08 083 030	30	a 30 b 32,5	14,0	24	6	61x31x52h	0,09	84	80x120x200h	1,92
08 083 035	35	a 35 b 38	23,0	28	4	36x36x41h	0,05	72	80x120x223h	2,14
08 083 040	40	a 40 b 43,5	34,0	32	2	41x41x57h	0,09	42	80x120x227h	2,18



Porto



Plato



- PORTO 14 + PLATO 12
- PORTO 16 + PLATO 14
- PORTO 20 + PLATO 16
- PORTO 25 + PLATO 20
- PORTO 30 + PLATO 24
- PORTO 35 + PLATO 28
- PORTO 40 + PLATO 32



Plato
pagina 72



Porto



Ruote
wheels

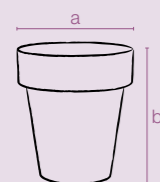

codice senza colore code without colour	Cm	dimensioni dimensions	litri liters	Confezione minima Minimum package	pezzi pallet pcs pallet
08 084 035	35	a35 b38	23,0	4 36x36x41h	72 80x120x223h
08 084 040	40	a40 b43,5	34,0	2 41x41x57h	42 80x120x227h

Porto ha il supporto per orchidea nelle misure 14 e 16

on the measures 14 and 16 Porto is featured with **orchids's** brackets

dans les mesures 14 et 16 Porto a un support pour les **orchidées**

Unterstützung für **Orchideen** in den Größen 14 - 16 vom Topf "Porto"

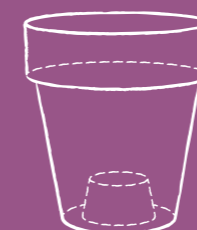



024
trasparente/transparent
transparent/transparent



022
bianco/white
blanc/weiß



010
rosso/red
rouge/rot



406
bruno/brown
brun/braun



404
cedro/cedar
cèdre/zeder



006
nero/black
noir/schwarz

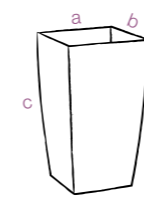

codice senza colore code without colour	Cm	dimensioni dimensions	litri liters	Confezione minima Minimum package	m ³	pezzi pallet pcs pallet	m ³
08 018 026	26	a15 b15 c26	4,4	12 46x31x36h	0,05	200 80x60x115h	0,55
08 018 035	35	a20 b20 c35	11,0	8 42x23x62h	0,06	88 80x60x115h	0,55
08 018 042	42	a25 b25 c42	20,0	4 51x26x51h	0,06	42 80x60x115h	0,55

Superficie lucida
Glossy surface
Surface brillante
Glänzende Oberfläche



Algarve

1

Algarve

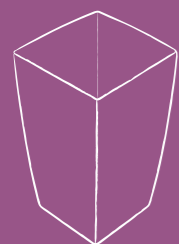

ideale per fiori recisi
ideal for cut flowers idéal
pour les fleurs coupées
ideal für Schnittblumen



Kit Algarve Water Reserve



codice senza colore code without colour	Cm	dimensioni dimensions			Confezione minima Minimum package		m ³
08 089 026	26	a 14	b 14	c 14	12	15x15x47h	0,01
08 089 035	35	a 18,5	b 18,5	c 20	8	20x20x45h	0,01
08 089 042	42	a 23,5	b 23,5	c 23	4	25x25x37h	0,02

3

2

Algarve + self watering

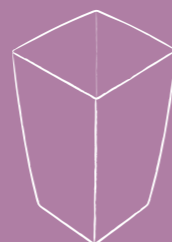

+

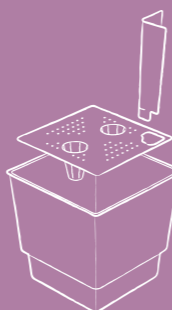

ideale come porta vaso
ideal as cachepot
idéal comme pot de fleurs
ideal als Übertopf

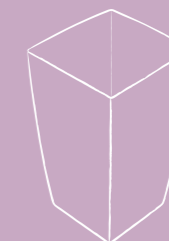

+

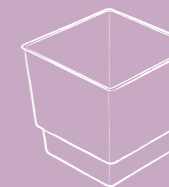

+



Algarve come portavaso



Linea Flortec
pagina 189



con riserva d'acqua
with water reserve system
avec réserve d'eau
mit Wasser-Reservoir

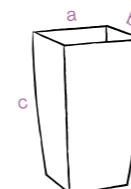

codice senza colore code without colour	Cm	dimensioni dimensions			litri liters	Confezione minima Minimum package		m ³	pezzi pallet pcs pallet		m ³
08 081 026	26	a 15	b 15	c 26	4,4	12	31x31x61h	0,05	50	80x60x115h	0,55
08 081 035	35	a 20	b 20	c 35	11,0	8	41x41x57h	0,09	44	80x60x115h	0,55
08 081 042	42	a 25	b 25	c 42	20,0	4	51x26x68h	0,09	18	80x60x115h	0,55



024
trasparente/transparent
transparent/transparent



022
bianco/white
blanc/weiß



401
peonia/peony
pivoine/pfingstrose



402
lilyum/lilyum
lilyum/lilyum



404
cedro/cedar
cèdre/zeder



407
salvia/sage
saug/salbei



406
bruno/brown
brun/braun



006
nero/black
noir/schwarz



Superficie lucida
Glossy surface
Surface brillante
Glänzende Oberfläche



Madeira
luxy

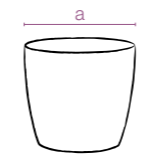

codice senza colore code without colour	Cm	dimensioni dimensions	litri liters	Confezione minima Minimum package	m ³	pezzi pallet pcs pallet	m ³
08 035 011	11	a11 b10	0,7	18 17x33x33h	0,01	756 80x120x115h	1,10
08 035 014	14	a14 b12,2	1,4	18 43x29x23h	0,02	972 80x120x225h	2,16
08 035 018	18	a18 b16,2	3,3	12 57x38x23h	0,05	432 80x120x225h	2,16
08 035 022	22	a22 b19,8	6,2	8 46x24x41h	0,04	240 80x120x225h	2,11



Superficie opaca
Matt finished
Surface opaque
Matt-Oberfläche



Madeira



022
bianco/white
blanc/weiß



010
rosso/red
rouge/rot



404
cedro/cedar
cèdre/zeder



406
bruno/brown
brun/braun



006
nero/black
noir/schwarz

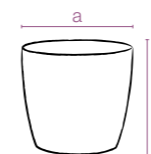

codice senza colore code without colour	Cm	dimensioni dimensions	litri liters	Confezione minima Minimum package	m ³	pezzi pallet pcs pallet	m ³
08 017 014	14	a14 b12,2	1,4	18 43x29x23h	0,02	400 80x60x115h	0,55
08 017 016	16	a16 b14,3	2,0	18 47x32x26h	0,03	304 80x60x115h	0,55
08 017 018	18	a18 b16,2	3,3	12 57x38x23h	0,05	216 80x60x115h	0,55
08 017 022	22	a22 b19,8	6,2	8 46x24x41h	0,04	104 80x60x115h	0,55
08 017 026	26	a26 b23,2	8,8	8 52x26x53h	0,07	48 80x60x115h	0,55



ideale come porta vaso
 idéal as cachepot
 idéal comme pot de fleurs
 ideal als Übertopf

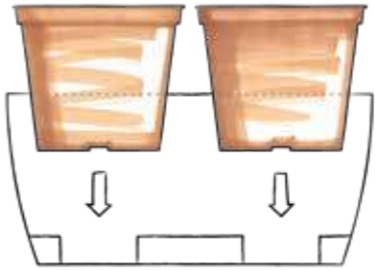

Linea Flortec
 pagina 189

COIMBRA cm 30
 Contiene 2 vasi da 14 cm
 Suitable to contain 2 pots cm 14
 Contient 2 pots de 14 cm
 Platz für zwei Vasen 14 cm

COIMBRA cm 25
 Contiene 2 vasi cm 12
 Suitable to contain 2 pots cm 12
 Contient 2 pots de 12 cm
 Platz für zwei Vasen 12 cm



024
 trasparente/transparent
 transparent/transparent



022
 bianco/white
 blanc/weiß



010
 rosso/red
 rouge/rot



404
 cedro/cedar
 cèdre/zeder



406
 bruno/brown
 brun/braun



006
 nero/black
 noir/schwarz



Superficie lucida
 Glossy surface
 Surface brillante
 Glänzende Oberfläche



Coimbra

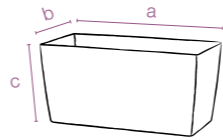

codice senza colore code without colour	Cm	dimensioni dimensions	litri liters	Confezione minima Minimum package	m ³	pezzi pallet pcs pallet	m ³
08 082 025	25	a26 b13 c12,5	4	12 28x28x34h	0,027	576 80x120x210h	2,02
08 082 030	30	a30 b15 c14	5	12 31x31x40h	0,038	432 80x120x210h	2,02



linea
BASIC



Cilindro



Campana



Ciotola Coste



Vaso Coste



Ciotola
Con Sottovaso



Sottovaso



Quadro



Cassettone



Sottovaso
Quadro



Sottocassettone



Cassetta Mare



Cassetta Cortina



Cassetta Tirol



Cassetta
Portofino



Cassetta Coste



Sottocassetta



407
salvia/sage
sauage/salbei



409
malva/mauve
mauve/malve



415
terra di Siena/terra di siena
terra di siena/terra di siena



414
fog grey/fog grey
brouillard gris/Nebel grau



Sottovaso
pagina 148

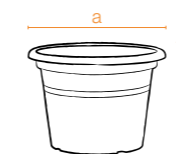

codice senza colore code without colour	Cm	dimensioni dimensions	litri liters	Confezione minima Minimum package	m ³	pezzi pallet pcs pallet	m ³			
01 001 020	20	a20 b14,2	2,5	18	20	20x20x36h	0,014	1440	80x120x120h	1,15
01 001 025	25	a25 b17,7	4,8	22	10	25x25x30h	0,019	720	80x120x110h	1,06
01 001 030	30	a30 b21,2	8,5	26	10	30x30x34h	0,031	400	80x120x110h	1,06
01 001 035	35	a35 b24,6	13	30	10	35x35x39h	0,048	300	80x120x120h	1,15
01 001 040	40	a40 b27,2	19	35	10	40x40x42h	0,067	300	80x120x120h	1,15
01 001 045	45	a45 b31,4	29	40	10	45x45x46h	0,093	330	80x120x230h	2,21
01 001 050	50	a50 b34,9	41	45	5	50x50x42h	0,105	380	100x120x220h	2,64



Superficie opaca
Matt finished
Surface opaque
Matt-Oberfläche



Cilindro
colour



Cilindro colour

Superficie opaca
Matt finished
Surface opaque
Matt-Oberfläche



022

bianco/white
blanc/weiß



403

corda/cord
corde/seil



406

bruno/brown
brun/braun



408

cacao/cocoa
cacao/kakao



018

ciclamino/cyclamen
cyclamen/zyklamfarbe



019

lilla/lilac
lilas/lila



404

cedro/cedar
cèdre/zeder



Sottovaso
pagina 148



Superficie opaca
Matt finished
Surface opaque
Matt-Oberfläche



Cilindro classic



001

terracotta/terracotta colour
couleur terre/farbe terrakotta



005

antracite/anthracite
anthracite/anthrazitgrau



Sottovaso
pagina 148

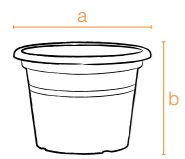

codice senza colore code without colour	Cm	dimensioni dimensions	litri liters	Confezione minima Minimum package	m ³	pezzi pallet pcs pallet	m ³
01 001 015	15	a15 b10,8	1,2	14	20	15x15x30h	0,007
01 001 018	18	a18 b12,8	2	16	20	18x18x32h	0,010
01 001 020	20	a20 b14,2	2,5	18	20	20x20x36h	0,014
01 001 025	25	a25 b17,7	4,8	22	10	25x25x30h	0,019
01 001 030	30	a30 b21,2	8,5	26	10	30x30x34h	0,031
01 001 035	35	a35 b24,6	13	30	10	35x35x39h	0,048
01 001 040	40	a40 b27,2	19	35	10	40x40x42h	0,067
01 001 045	45	a45 b31,4	29	40	10	45x45x46h	0,093
01 001 050	50	a50 b34,9	41	45	5	50x50x42h	0,105
01 001 060	60	a60 b41,8	69	52	5	60x60x50h	0,180
01 001 070	70	a70 b49	120	65	5	70x70x67h	0,328

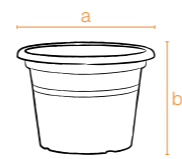

codice senza colore code without colour	Cm	dimensioni dimensions	litri liters	Confezione minima Minimum package	m ³	pezzi pallet pcs pallet	m ³
01 001 015	15	a15 b10,8	1,2	14	20	15x15x30h	0,007
01 001 018	18	a18 b12,8	2	16	20	18x18x32h	0,010
01 001 020	20	a20 b14,2	2,5	18	20	20x20x36h	0,014
01 001 025	25	a25 b17,7	4,8	22	10	25x25x30h	0,019
01 001 030	30	a30 b21,2	8,5	26	10	30x30x34h	0,031
01 001 035	35	a35 b24,6	13	30	10	35x35x39h	0,048
01 001 040	40	a40 b27,2	19	35	10	40x40x42h	0,067
01 001 045	45	a45 b31,4	29	40	10	45x45x46h	0,093
01 001 050	50	a50 b34,9	41	45	5	50x50x42h	0,105
01 001 060	60	a60 b41,8	69	52	5	60x60x50h	0,180
01 001 070	70	a70 b49	120	65	5	70x70x67h	0,328
01 001 090	90	a90 b64	240	80	5	90x90x82h	0,664





Superficie opaca
Matt finished
Surface opaque
Matt-Oberfläche



Campana colour



022

bianco/white
blanc/weiß



018

ciclamino/cyclamen
cyclamen/zyklamfarbe



019

lilla/lilac
lilas/lila



404

cedro/cedar
cèdre/zeder



Sottovaso
pagina 148

codice senza colore code without colour	Cm	dimensioni dimensions	litri liters		Confezione minima Minimum package	m ³	pezzi pallet pcs pallet	m ³
01 002 020	20	a20 b13,8	2,2	18	20 20x20x40h	0,01	1080 80x120x113h	1,08
01 002 025	25	a25 b17,2	4,4	22	10 25x25x33h	0,02	600 80x120x115h	1,10



Superficie opaca
Matt finished
Surface opaque
Matt-Oberfläche



Campana classic



001

terracotta/terracotta colour
couleur terre/farbe terrakotta



005

antracite/anthracite
anthracite/anthrazitgrau



Sottovaso
pagina 148

codice senza colore code without colour	Cm	dimensioni dimensions	litri liters		Confezione minima Minimum package	m ³	pezzi pallet pcs pallet	m ³
01 002 020	20	a20 b13,8	2,2	18	20 20x20x40h	0,01	1080 80x120x113h	1,08
01 002 025	25	a25 b17,2	4,4	22	10 25x25x33h	0,02	600 80x120x115h	1,10
01 002 030	30	a30 b20,7	7,5	26	10 30x30x37h	0,03	400 80x120x120h	1,15
01 002 035	35	a35 b24,1	12	30	10 35x35x41h	0,05	240 80x120x113h	1,08
01 002 040	40	a40 b26,8	16,5	35	10 40x40x45h	0,07	240 80x120x120h	1,15
01 002 045	45	a45 b31,1	25,5	40	10 45x45x51h	0,10	320 100x120x213h	2,56
01 002 050	50	a50 b34,6	35	45	5 50x50x45h	0,11	320 100x120x225h	2,70
01 002 060	60	a60 b41,4	60	52	5 60x60x53h	0,19	260 120x120x215h	2,58

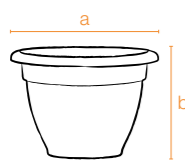

Ciotola coste

Superficie opaca / Matt finished
Surface opaque / Matt-Oberfläche



001

terracotta/terracotta colour
couleur terre/farbe terrakotta



005

antracite/anthracite
anthracite/anthrazitgrau

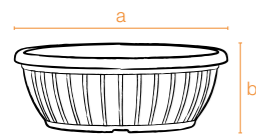

codice senza colore code without colour	Cm	dimensioni dimensions	litri liters		Confezione minima Minimum package	m ³	pezzi pallet pcs pallet	m ³
01 010 020	20	a20 b8	1,6	20	20x20x35h	0,01	1200	80x120x110h 1,06
01 010 025	25	a25 b9	3	26	25x25x25h	0,01	600	80x120x105h 1,01
01 010 030	30	a30 b11	5,2	30	30x30x29h	0,02	360	80x120x103h 0,99
01 010 035	35	a35 b12,5	8	35	35x35x31h	0,03	280	80x120x114h 1,09
01 010 040	40	a40 b14	12	40	40x40x38h	0,06	180	80x120x107h 1,03
01 010 050	50	a50 b18	24	52	50x50x43h	0,10	280	100x120x220h 2,64

Ciotola con sottovaso

Superficie opaca / Matt finished
Surface opaque / Matt-Oberfläche



001

terracotta/terracotta colour
couleur terre/farbe terrakotta



005

antracite/anthracite
anthracite/anthrazitgrau

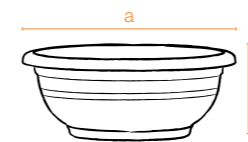

codice senza colore code without colour	Cm	dimensioni dimensions	litri liters		Confezione minima Minimum package	m ³	pezzi pallet pcs pallet	m ³
01 009 030	30	a30 b11,5	5	incl	10 30x30x25h	0,02	400	80x120x105h 1,01
01 009 040	40	a40 b15,5	11,5	incl	10 40x40x32h	0,05	240	80x120x103h 0,99
01 009 050	50	a50 b18		incl	10 50x50x38h	0,09	360	100x120x212h 2,54

Vaso coste

Superficie opaca / Matt finished
Surface opaque / Matt-Oberfläche



001

terracotta/terracotta colour
couleur terre/farbe terrakotta



005

antracite/anthracite
anthracite/anthrazitgrau

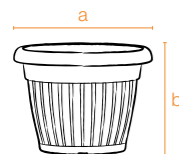

codice senza colore code without colour	Cm	dimensioni dimensions	litri liters		Confezione minima Minimum package	m ³	pezzi pallet pcs pallet	m ³
01 003 020	20	a20 b14,8	2,5	18	20x20x46h	0,01	900	80x120x110h 1,06
01 003 025	25	a25 b18,4	4,9	22	25x25x52h	0,03	240	80x120x105h 1,01
01 003 030	30	a30 b21,8	8,4	26	30x30x56h	0,05	160	80x120x105h 1,01
01 003 035	35	a35 b25,7	13	30	35x35x59h	0,07	120	80x120x110h 1,06
01 003 040	40	a40 b29,4	20	35	40x40x61h	0,09	120	80x120x115h 1,10
01 003 045	45	a45 b33,1	29	40	45x45x64h	0,13	150	80x120x215h 2,06
01 003 050	50	a50 b36,8	40	45	50x50x51h	0,12	200	100x120x227h 2,72
01 003 060	60	a60 b44,1	70	52	60x60x58h	0,20	100	80x120x210h 2,11

misura 30 cm disponibile
anche con gancio
hook available for size 30 cm
Haken für 30er Größe
verfügbar
crochet disponible pour
mesure 30 cm

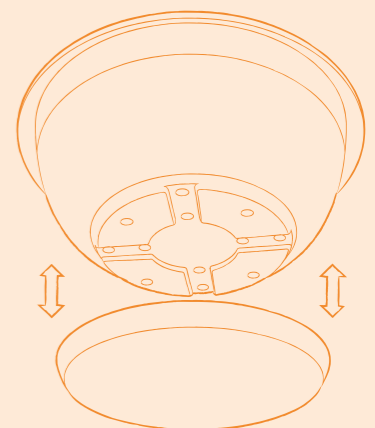

Il sottovaso è incluso e viene fissato ad incastro.

The saucer is included and is fitted into.
La soucoupe est inclus et est emboîtée dans.

Der Untersetzer ist eingeschlossen und mit Clip-Funktion zusammengesteckt.

Sottovaso colour

Superficie opaca / Matt finished
Surface opaque / Matt-Oberfläche



022
bianco/white
blanc/weiß



403
corda/cord
corde/seil



406
bruno/brown
brun/braun



408
cacao/cocoa
cacao/kakao



018
ciclamino/cyclamen
cyclamen/zyklamfarbe



019
lilla/lilac
lilas/lila



404
cedro/cedar
cèdre/zeder



407
salvia/sage
sauge/salbei



409
malva/mauve
mauve/malve



415
terra di Siena/terra di siena
terra di siena/terra di siena



414
fog grey/fog grey
brouillard gris/Nebel grau

codice senza colore code without colour	Cm	dimensioni dimensions	Confezione minima Minimum package	m ³	pezzi pallet pcs pallet	m ³
01 011 014	14	a14 b1,8	20 14x14x7,5h	0,002	2200	0,12
01 011 016	16	a16 b1,9	20 16x16x8,5h	0,002	1400	0,12
01 011 018	18	a18 b2,3	20 18x18x8,5h	0,003	1200	0,12
01 011 022	22	a22 b3	10 22x22x6h	0,003	500	0,12
01 011 026	26	a26 b3,7	50 26x26x24h	0,016	300	0,12
01 011 030	30	a30 b4,1	25 30x30x15h	0,014	200	0,12
01 011 035	35	a35 b5,1	25 35x35x15h	0,018	125	0,12
01 011 040	40	a40 b5,2	25 40x40x15h	0,024	125	0,12
01 011 045	45	a45 b5,5	25 45x45x17h	0,034	600	1,10
01 011 052	52	a52 b6,6	25 52x52x19h	0,051	350	0,96
01 011 065	65	a66 b6	5 66x66x9h	0,039	130	0,74

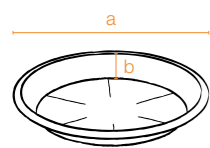

Sottovaso classic

Superficie opaca / Matt finished
Surface opaque / Matt-Oberfläche

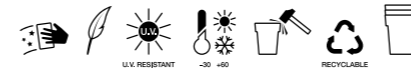

001
terracotta/terracotta colour
couleur terre/farbe terrakotta



005
antracite/anthracite
anthracite/anthrazitgrau

codice senza colore code without colour	Cm	dimensioni dimensions	Confezione minima Minimum package	m ³	pezzi pallet pcs pallet	m ³
01 011 012	12	a12 b1,5	100 12x12x28h	0,004	2800	0,12
01 011 014	14	a14 b1,8	100 14x14x32h	0,006	2200	0,12
01 011 016	16	a16 b1,9	100 16x16x32h	0,008	1400	0,12
01 011 018	18	a18 b2,3	100 18x18x32h	0,010	1200	0,12
01 011 020	20	a20 b2,9	50 20x20x20h	0,008	700	0,12
01 011 022	22	a22 b3	50 22x22x24h	0,012	500	0,12
01 011 024	24	a24 b3,6	50 24x24x20h	0,012	450	0,12
01 011 026	26	a26 b3,7	50 26x26x24h	0,016	300	0,12
01 011 028	28	a28 b4,1	50 28x28x24h	0,019	300	0,12
01 011 030	30	a30 b4,1	25 30x30x15h	0,014	200	0,12
01 011 035	35	a35 b5,1	25 35x35x15h	0,018	125	0,12
01 011 040	40	a40 b5,2	25 40x40x15h	0,024	125	0,12
01 011 045	45	a45 b5,5	25 45x45x17h	0,034	600	1,10
01 011 052	52	a52 b6,6	25 52x52x19h	0,051	350	0,96
01 011 065	65	a65 b6	5 65x65x9h	0,039	130	0,74
01 011 080	80	a80 b6,6	5 80x80x10h	0,077	130	1,37

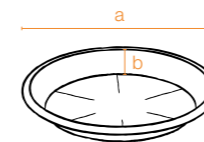



Superficie opaca
Matt finished
Surface opaque
Matt-Oberfläche



Quadro colour



403
corda/cord
corde/seil



406
bruno/brown
brun/braun



408
cacao/cocoa
cacao/kakao



Sottovaso
pagina 154

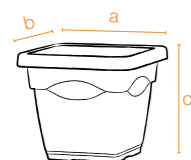

codice senza colore code without colour	Cm	dimensioni dimensions	litri liters		Confezione minima Minimum package	m ³	pezzi pallet pcs pallet	m ³
01 007 032	32	a32 b32 c28	14	27	10 32x32x49h	0,05	210 80x120x115h	1,10
01 007 038	38	a38 b38 c33,5	25	33	10 38x38x56h	0,08	180 80x120x110h	1,06
01 007 045	45	a45 b45 c40	42	38	10 45x45x69h	0,14	200 100x120x212h	2,54



Superficie opaca
Matt finished
Surface opaque
Matt-Oberfläche



Quadro classic



001
terracotta/terracotta colour
couleur terre/farbe terrakotta



005
antracite/anthracite
anthracite/anthrazitgrau



Sottovaso
pagina 154

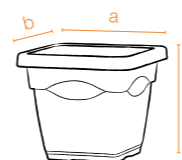

codice senza colore code without colour	Cm	dimensioni dimensions	litri liters		Confezione minima Minimum package	m ³	pezzi pallet pcs pallet	m ³
01 007 032	32	a32 b32 c28	14	27	10 32x32x49h	0,05	210 80x120x115h	1,10
01 007 038	38	a38 b38 c33,5	25	33	10 38x38x56h	0,08	180 80x120x110h	1,06
01 007 045	45	a45 b45 c40	42	38	10 45x45x69h	0,14	200 100x120x212h	2,54





Superficie opaca
Matt finished
Surface opaque
Matt-Oberfläche



Cassettone colour



403

corda/cord
corde/seil



406

bruno/brown
brun/braun



408

cacao/cocoa
cacao/kakao



Sottocassettone
pagina 155

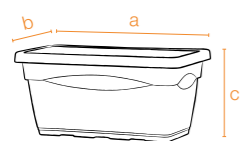

codice senza colore code without colour	Cm	dimensioni dimensions		litri liters		Confezione minima Minimum package	m ³	pezzi pallet pcs pallet		m ³
01 008 060	60	a60	b32	c27,5	31	60	5 60x32x37h	0,07	420	100x120x224h 2,69
01 008 080	80	a80	b37	c32,8	60	80	5 80x37x43h	0,12	210	80x120x224h 2,15
01 008 100	100	a100	b40	c37,5	92	100	5 100x40x54h	0,21	100	100x120x228h 2,74



Superficie opaca
Matt finished
Surface opaque
Matt-Oberfläche



Cassettone classic



001

terracotta/terracotta colour
couleur terre/farbe terrakotta



005

antracite/anthracite
anthracite/anthrazitgrau



Sottocassettone
pagina 155

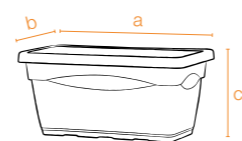

codice senza colore code without colour	Cm	dimensioni dimensions		litri liters		Confezione minima Minimum package	m ³	pezzi pallet pcs pallet		m ³
01 008 060	60	a60	b32	c27,5	31	60	5 60x32x37h	0,07	420	100x120x224h 2,69
01 008 080	80	a80	b37	c32,8	60	80	5 80x37x43h	0,12	210	80x120x224h 2,15
01 008 100	100	a100	b40	c37,5	92	100	5 100x40x54h	0,21	100	100x120x228h 2,74



Sottovaso Quadro

colour

Superficie opaca / Matt finished
Surface opaque / Matt-Oberfläche

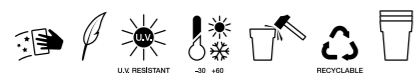

403
corda/cord
corde/seil



406
bruno/brown
brun/braun



408
cacao/cocoa
cacao/kakao

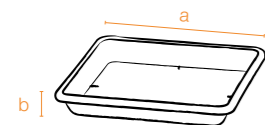

codice senza colore code without colour	Cm	dimensioni dimensions	Confezione minima Minimum package	m³	pezzi pallet pcs pallet	m³
01 013 027	27	a27 b4	10 27x27x11h	0,01	140 60x40x50h	0,12
01 013 033	33	a33 b5	10 33x33x13h	0,01	70 60x40x50h	0,12
01 013 038	38	a37,5 b6	10 38x38x16h	0,02	50 60x40x50h	0,12

Sottocassettone

colour

Superficie opaca / Matt finished
Surface opaque / Matt-Oberfläche



403
corda/cord
corde/seil



406
bruno/brown
brun/braun



408
cacao/cocoa
cacao/kakao

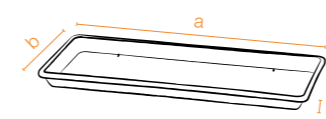

codice senza colore code without colour	Cm	dimensioni dimensions	Confezione minima Minimum package	m³	pezzi pallet pcs pallet	m³
01 014 060	60	a56 b28 c4,3	5 56x28x7h	0,01	60 60x40x50h	0,12
01 014 080	80	a75 b32 c5,1	5 75x33x9h	0,02	285 80x120x115h	1,10
01 014 100	100	a95 b35 c5,2	5 95x35x11h	0,03	160 80x120x115h	1,10

Sottovaso Quadro

Superficie opaca / Matt finished
Surface opaque / Matt-Oberfläche



001
terracotta/terracotta colour
couleur terre/farbe terrakotta



005
antracite/anthracite
anthracite/anthrazitgrau

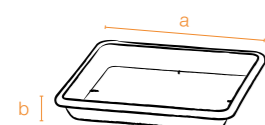

codice senza colore code without colour	Cm	dimensioni dimensions	Confezione minima Minimum package	m³	pezzi pallet pcs pallet	m³
01 013 027	27	a27 b4	10 27x27x11h	0,01	140 60x40x50h	0,12
01 013 033	33	a33 b5	10 33x33x13h	0,01	70 60x40x50h	0,12
01 013 038	38	a37,5 b6	10 38x38x16h	0,02	50 60x40x50h	0,12

Sottocassettone

Superficie opaca / Matt finished
Surface opaque / Matt-Oberfläche



001
terracotta/terracotta colour
couleur terre/farbe terrakotta



005
antracite/anthracite
anthracite/anthrazitgrau

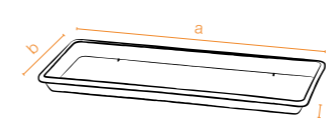

codice senza colore code without colour	Cm	dimensioni dimensions	Confezione minima Minimum package	m³	pezzi pallet pcs pallet	m³
01 014 060	60	a56 b28 c4,3	5 56x28x7h	0,01	60 60x40x50h	0,12
01 014 080	80	a75 b32 c5,1	5 75x33x9h	0,02	285 80x120x115h	1,10
01 014 100	100	a95 b35 c5,2	5 95x35x11h	0,03	160 80x120x115h	1,10



Cassetta mare colour



Superficie opaca
Matt finished
Surface opaque
Matt-Oberfläche



UV RESISTANT

-30 +60

RECYCLABLE



407
salvia/sage
saugé/salbei



409
malva/mauve
mauve/malve



415
terra di Siena/terra di siena
terra di siena/terra di siena



414
fog grey/fog grey
brouillard gris/Nebel grau



Sottocassetta
pagina 168

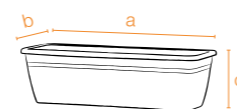

codice senza colore code without colour	Cm	dimensioni dimensions	litri liters	Confezione minima Minimum package	m ³	pezzi pallet pcs pallet	m ³	accessori accessories
01 004 040	40	a:40 b:17 c:14,5	6	10 40x17x30h	0,02	700	80x120x115h	1,10
01 004 050	50	a:50 b:17 c:14,5	8	10 50x17x30h	0,02	450	80x120x118h	1,13
01 004 060	60	a:60 b:17 c:14,5	10	10 60x17x30h	0,03	450	80x120x115h	1,10



Superficie opaca
Matt finished
Surface opaque
Matt-Oberfläche



Cassetta mare colour



022

bianco/white
blanc/weiß



403

corda/cord
corde/seil



406

bruno/brown
brun/braun



408

cacao/cocoa
cacao/kakao



018

ciclamino/cyclamen
cyclamen/zyklamfarbe



019

lilla/lilac
lilas/lila



404

cedro/cedar
cèdre/zeder



Sottocassetta
pagina 168

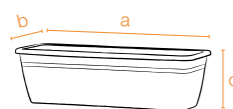

supporto mare
pagina 167

codice senza colore code without colour	Cm	dimensioni dimensions	litri liters	Confezione minima Minimum package	m ³	pezzi pallet pcs pallet	m ³	accessori accessories
01 004 040	40	a40 b17 c14,5	6	10 40x17x30h	0,02	700 80x120x115h	1,10	
01 004 050	50	a50 b17 c14,5	8	10 50x17x30h	0,02	450 80x120x118h	1,13	
01 004 060	60	a60 b17 c14,5	10	10 60x17x30h	0,03	450 80x120x115h	1,10	
01 004 080	80	a80 b17 c14,5	12	10 80x17x30h	0,04	240 80x120x105h	1,01	



Superficie opaca
Matt finished
Surface opaque
Matt-Oberfläche



Cassetta mare classic



001

terracotta/terracotta colour
couleur terre/farbe terrakotta



005

antracite/anthracite
anthracite/anthrazitgrau



Sottocassetta
pagina 168

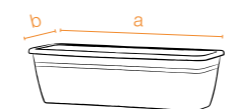

supporto mare
pagina 167

codice senza colore code without colour	Cm	dimensioni dimensions	litri liters	Confezione minima Minimum package	m ³	pezzi pallet pcs pallet	m ³	accessori accessories
01 004 040	40	a40 b17 c14,5	6	10 40x17x30h	0,02	700 80x120x115h	1,10	
01 004 050	50	a50 b17 c14,5	8	10 50x17x30h	0,02	450 80x120x118h	1,13	
01 004 060	60	a60 b17 c14,5	10	10 60x17x30h	0,03	450 80x120x115h	1,10	
01 004 080	80	a80 b17 c14,5	12	10 80x17x30h	0,04	240 80x120x105h	1,01	





Superficie opaca
Matt finished
Surface opaque
Matt-Oberfläche



Superficie opaca
Matt finished
Surface opaque
Matt-Oberfläche



Cassetta Cortina colour

Cassetta Cortina classic



022
bianco/white
blanc/weiß



406
bruno/brown
brun/braun



018
ciclamino/cyclamen
cyclamen/zyklamfarbe



404
cedro/cedar
cèdre/zeder



Sottocassetta
pagina 168



001
terracotta/terracotta colour
couleur terre/farbe terrakotta



005
antracite/anthracite
anthracite/anthrazitgrau



Sottocassetta
pagina 168

codice senza colore code without colour	Cm	dimensioni dimensions			litri liters		Confezione minima Minimum package			m³	pezzi pallet pcs pallet		m³
01 104 040	40	a40	b18	c14	10	40	5	40x18x22h	0,01	480	80x120x106h	1,08	
01 104 060	60	a60	b18	c14	15	60	5	60x18x22h	0,02	320	80x120x106h	1,08	
01 104 080	80	a80	b18	c14	20	80	5	80x18x22h	0,03	240	80x120x106h	1,08	
01 104 100	100	a100	b18	c14	25	100	5	100x18x22h	0,04	160	80x120x106h	1,08	

codice senza colore code without colour	Cm	dimensioni dimensions			litri liters		Confezione minima Minimum package			m³	pezzi pallet pcs pallet		m³
01 104 040	40	a40	b18	c14	10	40	5	40x18x22h	0,01	480	80x120x106h	1,08	
01 104 060	60	a60	b18	c14	15	60	5	60x18x22h	0,02	320	80x120x106h	1,08	
01 104 080	80	a80	b18	c14	20	80	5	80x18x22h	0,03	240	80x120x106h	1,08	
01 104 100	100	a100	b18	c14	25	100	5	100x18x22h	0,04	160	80x120x106h	1,08	

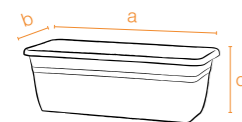

Cassetta Tirol

Superficie opaca / Matt finished
Surface opaque / Matt-Oberfläche

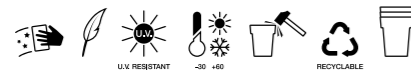

“La cassetta Tirol contiene davvero tanta terra e riesco a coltivare molte varietà di piante.”
“The balcony box Tirol really contains a lot of compost so I can cultivate many plant varieties”
“La jardinière Tirol contient beaucoup de terre et je peux cultiver toute variété de plantes”
“Der Blumenkasten Tirol enthält wirklich viel Erde und ich kann viele Pflanzensorten züchten.”

Linda



001

terracotta/terracotta colour
couleur terre/farbe terrakotta



005

antracite/anthracite
anthracite/anthrazitgrau



Sottocassetta
pagina 168

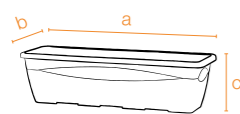

codice senza colore code without colour	Cm	dimensioni dimensions	litri liters	Confezione minima Minimum package	m ³	pezzi pallet pcs pallet	m ³
01 006 040	40	a40 b20 c16	8	40	10	40x20x31h	0,02
01 006 050	50	a50 b20 c16	10,5	50	10	50x20x31h	0,03
01 006 060	60	a60 b20 c16	13	60	10	60x20x31h	0,03



Superficie opaca
Matt finished
Surface opaque
Matt-Oberfläche

Cassetta Portofino colour



022

bianco/white
blanc/weiß



406

bruno/brown
brun/braun



018

ciclamino/cyclamen
cyclamen/zyklamfarbe



404

cedro/cedar
cèdre/zeder



mesures 80 - 100
sizes 80 - 100

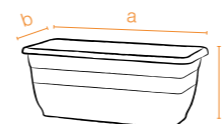

codice senza colore code without colour	Cm	dimensioni dimensions	litri liters	Confezione minima Minimum package	m ³	pezzi pallet pcs pallet	m ³
01 105 040	40	a40 b20 c16,5	13	5	40x20x32h	0,02	240 80x120x110h 1,06
01 105 060	60	a60 b20 c16,5	20	5	60x20x32h	0,03	160 80x120x110h 1,06
01 105 080	80	a80 b20 c16,5	26	5	80x20x32h	0,05	120 80x120x110h 1,06
01 105 100	100	a100 b20 c16,5	33	5	100x20x32h	0,06	80 80x120x110h 1,06





Superficie opaca
Matt finished
Surface opaque
Matt-Oberfläche



Cassetta Portofino classic



001

terracotta/terracotta colour
couleur terre/farbe terrakotta



005

antracite/anthracite
anthracite/anthrazitgrau

misure 80 - 100
sizes 80 - 100

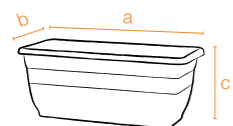

codice senza colore code without colour	Cm	dimensioni dimensions			litri liters	Confezione minima Minimum package	m ³	pezzi pallet pcs pallet	m ³
01 105 040	40	a40	b20	c16,5	13	5 40x20x32h	0,02	240 80x120x110h	1,06
01 105 060	60	a60	b20	c16,5	20	5 60x20x32h	0,03	160 80x120x110h	1,06
01 105 080	80	a80	b20	c16,5	26	5 80x20x32h	0,05	120 80x120x110h	1,06
01 105 100	100	a100	b20	c16,5	33	5 100x20x32h	0,06	80 80x120x110h	1,06

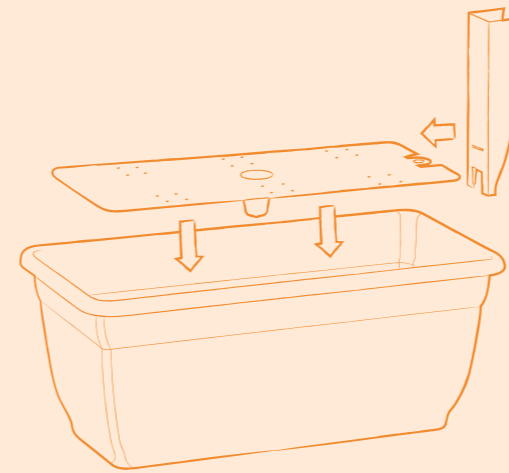

diffusione dell'acqua
per osmosi
water diffusion through
osmosis's effect
diffusion de l'eau par
osmose
Wasserdiffusion durch
Osmose

beccuccio per
inserimento dell'acqua
spout for water insertion
bec pour l'introduction
de l'eau
Füllschacht zur
Wasserversorgung

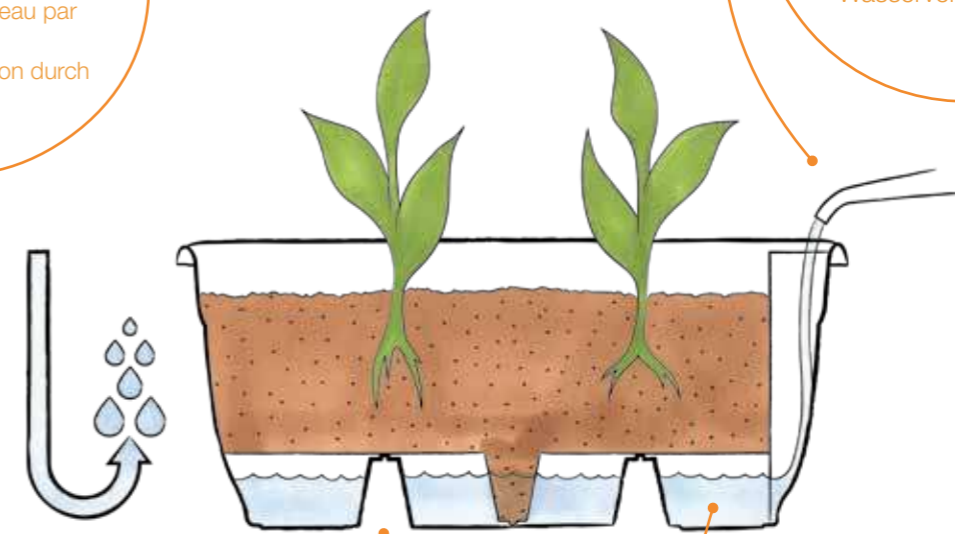

foro di drenaggio per
l'acqua in eccesso
drainage bore for water's
excess
trou de drainage pour
l'eau en excès
Entwässerungsloch

riserva d'acqua
water reserve
réserve d'eau
Wasser-Reservoir



Cassetta Coste

Superficie opaca / Matt finished
Surface opaque / Matt-Oberfläche

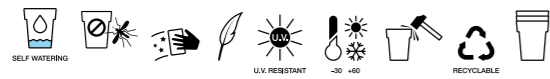

001
terracotta/terracotta colour
couleur terre/farbe terrakotta



005
antracite/anthracite
anthracite/anthrazitgrau

diffusione dell'acqua per osmosi
water diffusion through osmosis's effect
diffusion de l'eau par osmose
Wasserdiffusion durch Osmose

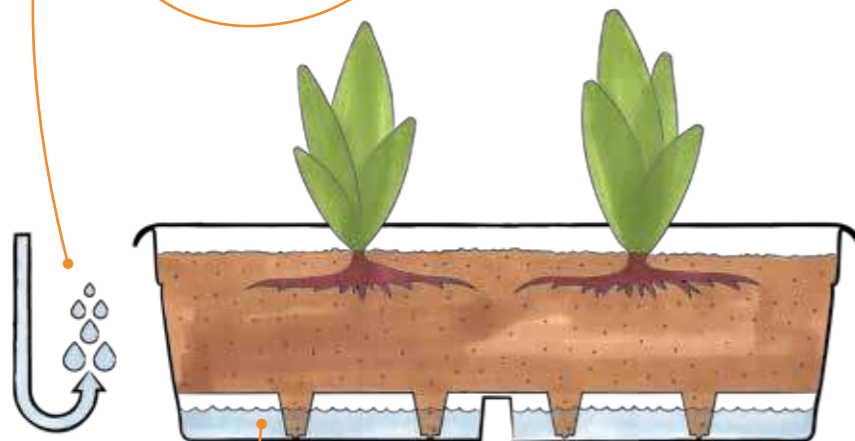

riserva d'acqua
water reserve
réserve d'eau
Wasser-Reservoir

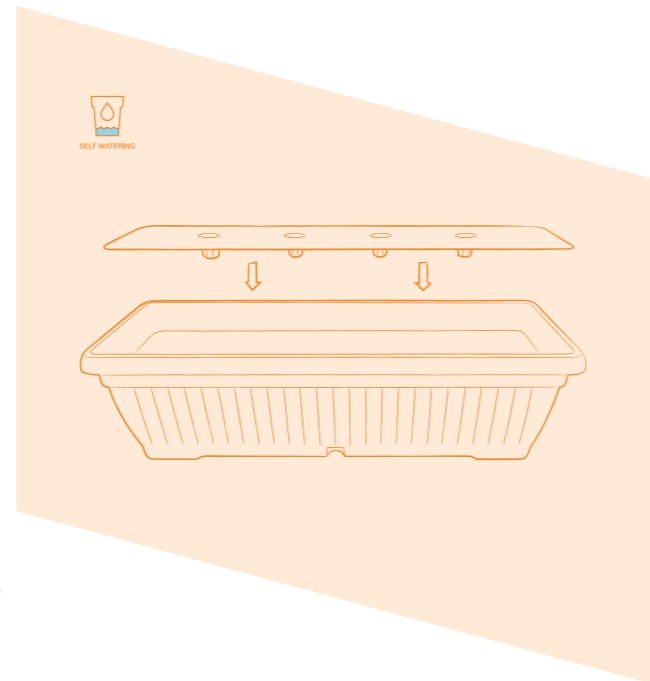

supporto coste
pagina 167

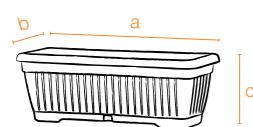

codice senza colore code without colour	Cm	dimensioni dimensions	litri liters	Confezione minima Minimum package	pezzi pallet pcs pallet	accessori accessories
01 005 040	40	a40 b20 c17	8	10 40x20x43h	0,03 360 80x120x115h	1,10
01 005 050	50	a50 b20 c17	10,5	10 50x20x43h	0,04 270 80x120x115h	1,10
01 005 060	60	a60 b20 c17	13	10 60x20x43h	0,05 240 80x120x118h	1,13

kit balcone Coste

Superficie opaca / Matt finished
Surface opaque / Matt-Oberfläche

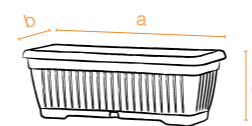
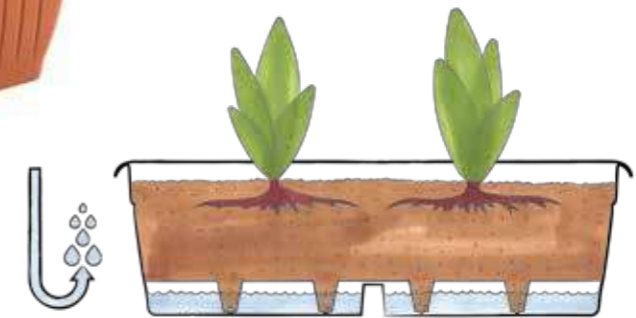

codice senza colore code without colour	Cm	dimensioni dimensions	Confezione minima Minimum package	pezzi pallet pcs pallet
01 016 040	40	a40 b27 c17,3	104 80x60x115h	0,55 224 80x120x115h
01 016 050	50	a50 b20 c17,3	78 80x60x115h	0,55 168 80x120x115h
01 016 060	60	a60 b20 c17,3	78 80x60x115h	0,55 168 80x120x115h

supporto Coste

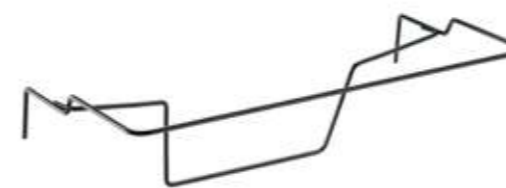

codice senza colore code without colour	Cm	Confezione minima Minimum package
10 901 040	40	10 40x28x30h
10 901 050	50	10 50x28x30h
10 901 060	60	10 60x28x30h

supporto Mare

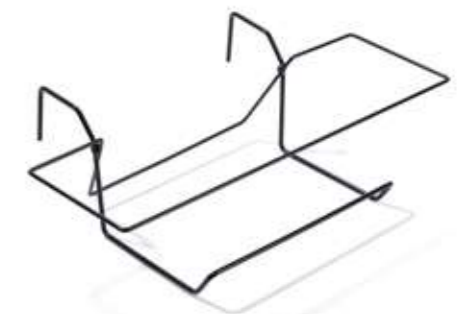

codice senza colore code without colour	Cm	Confezione minima Minimum package
10 900 040	40	10 46x30x24h
10 900 050	50	10 56x30x24h
10 900 060	60	10 66x30x24h
10 900 080	80	10 86x30x24h



Sottocassetta colour

Superficie opaca
Matt finished
Surface opaque
Matt-Oberfläche



022
bianco/white
blanc/weiß



403
corda/cord
corde/seil



406
bruno/brown
brun/braun



408
cacao/cocoa
cacao/kakao



018
ciclamino/cyclamen
cyclamen/zyklamfarbe



019
lilla/lilac
lilas/lila



404
cedro/cedar
cèdre/zeder



407
salvia/sage
saugé/salbei



409
malva/mauve
mauve/malve



415
terra di Siena/terra di siena
terra di siena/terra di siena



414
fog grey/fog grey
brouillard gris/Nebel grau

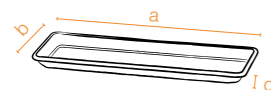

codice senza colore code without colour	Cm	dimensioni dimensions	litri liters	Confezione minima Minimum package	m ³	pezzi pallet pcs pallet	m ³
01 012 040	40	a38 b19 c3,2	2	10 38x19x15h	0,01	240	0,12
01 012 050	50	a48 b19 c3,2	3	10 48x19x15h	0,01	160	0,12
01 012 060	60	a58 b19 c3,2	5	10 58x19x15h	0,01	160	0,12
01 012 080	80	a78 b19 c3,2	8	10 78x19x15h	0,02	1080	1,10
01 012 100	100	a98 b19 c3,2	10	10 98x19x15h	0,02	720	1,10



Superficie opaca
Matt finished
Surface opaque
Matt-Oberfläche

Sottocassetta classic



001
terracotta/terracotta colour
couleur terre/farbe terrakotta



005
antracite/anthracite
anthracite/anthrazitgrau

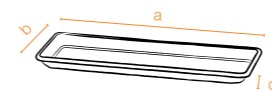

codice senza colore code without colour	Cm	dimensioni dimensions	litri liters	Confezione minima Minimum package	m ³	pezzi pallet pcs pallet	m ³
01 012 040	40	a38 b19 c3,2	2	10 38x19x15h	0,01	240	0,12
01 012 050	50	a48 b19 c3,2	3	10 48x19x15h	0,01	160	0,12
01 012 060	60	a58 b19 c3,2	5	10 58x19x15h	0,01	160	0,12
01 012 080	80	a78 b19 c3,2	8	10 78x19x15h	0,02	1080	1,10
01 012 100	100	a98 b19 c3,2	10	10 98x19x15h	0,02	720	1,10



disponibile anche:
also available:
aussi disponible:
verfügbar auch:



Espositore Hydral

Codice ESPOSITORE:
Code for empty Hydral display:
Code du présentoir vide pour les Hydral:
Kode für den leeren Ständer des Hydrals:
10919830000

L'espositore è adatto per contenere i nostri articoli HYDRAL nelle seguenti misure e quantità:

The Display is suitable to hold our HYDRAL in the following sizes and quantities:

Le présentoir est apte à contenir nos articles HYDRAL dans les tailles et quantités suivantes:

Der Präsentationsständer ist für unseren Artikel HYDRAL geeignet und kann folgende Größen und Mengen enthalten:

codice senza colore code without colour	descrizione	quantità totale consigliata	minimo vendita per colore
28 107 018	hydral 18	20	20
28 107 023	hydral 23	20	10
28 107 028	hydral 28	20	10
28 107 033	hydral 33	20	5
28 107 038	hydral 38	20	8



Display

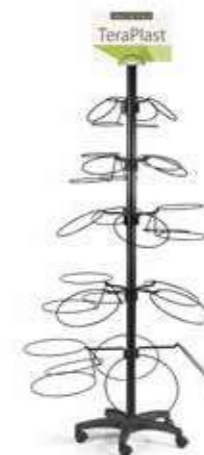

disponibile anche: / also available:
aussi disponible: / verfügbar auch:



Espositore cilindri e sottovasi

Codice ESPOSITORE:
Code for empty Cylinder and Saucers display:
Code du présentoir vide pour les Cylindres et Soucoupes:
Kode für den leeren Ständer der Zylinder und Untersetzer:
10915830000

L'espositore è adatto per contenere i nostri articoli CILINDRO INIEZIONE e SOTTOVASO INIEZIONE nelle seguenti misure e quantità:

The Display is suitable to hold our ITEMS CYLINDER INJECTION AND SAUCER INJECTION in the following sizes and quantities:

Le présentoir est apte à contenir nos articles CYLINDRE INJECTÉ et SOUCOUPES dans les tailles et quantités suivantes:

Der Präsentationsständer ist für unseren Artikel INJEKTION ZYLINDER TOPF und UNTERSETZER RUND in den folgenden Größen und Mengen als Behälter geeignet:

codice senza colore code without colour	descrizione	quantità totale consigliata	minimo vendita per colore
01 001 020	Cilindro cm 20	10	20
01 001 025	Cilindro cm 25	10	10
01 001 030	Cilindro cm 30	10	10
01 001 035	Cilindro cm 35	10	10
01 001 040	Cilindro cm 40	5	10

codice senza colore code without colour	descrizione	quantità totale consigliata	minimo vendita per colore
01 011 018	Sottovaso cm 18	10	100
01 011 022	Sottovaso cm 22	10	50
01 011 026	Sottovaso cm 26	10	50
01 011 030	Sottovaso cm 30	10	25
01 011 035	Sottovaso cm 35	5	25



disponibile anche:
also available:
aussi disponible:
verfügbar auch:



Espositore cassette e sottocassette

Codice ESPOSITORE:

Code for empty Balcony boxes and saucers display:

Code du présentoir vide pour les cylindres et les soucoupes:

Kode für den leeren Ständer von Zylinder und Untersetzer:

10918830000

L'espositore è adatto per contenere le CASSETTE e LE SOTTOCASSETTE INIEZIONE nelle seguenti misure e quantità:

The Display is suitable to contain our items BALCONY BOXES INJECTION AND SAUCER INJECTION in the following sizes and quantities:

Le présentoir est apte à contenir nos articles JARDINIÈRE et SOUCOUBE JARDINIÈRE INJECTÉ dans les tailles et quantités suivantes:

Der Präsentationsständer ist für unseren Artikel BALKONKASTEN und UNTERSETZER BALKONKASTEN in folgenden Größen und Mengen als Behälter geeignet:

codice senza colore code without colour	descrizione	quantità totale consigliata	minimo vendita per colore
01 004 040	Cassetta cm 40	15	10
01 004 050	Cassetta cm 50	15	10
01 004 060	Cassetta cm 60	15	10
01 004 080	Cassetta cm 80	15	10

codice senza colore code without colour	descrizione	quantità totale consigliata	minimo vendita per colore
01 012 040	Sottocassetta cm 40	15	10
01 012 050	Sottocassetta cm 50	15	10
01012060	Sottocassetta cm 60	15	10
01 012 080	Sottocassetta cm 80	15	10

Espositore cilindri

Codice ESPOSITORE CILINDRI:

Code for Cylinder display:

Code du présentoir pour les Cylindres:

Kode für Zylinderständer:

10911830000

L'espositore è adatto per contenere il nostro articolo CILINDRO INIEZIONE nelle seguenti misure e quantità:

The Display is suitable to hold our article CYLINDER INJECTION in the following sizes and quantities:

Le présentoir est apte à contenir notre article CYLINDRE INJECTÉ dans les tailles et quantités suivantes:

Der Präsentationsständer ist für unseren Artikel INJEKTION ZYLINDER TOPF in den folgenden Größen und Mengen als Behälter geeignet:



codice senza colore code without colour	descrizione	quantità totale consigliata	minimo vendita per colore
01 001 020	Cilindro cm 20	40	20
01 001 025	Cilindro cm 25	40	10
01 001 030	Cilindro cm 30	40	10
01 001 035	Cilindro cm 35	40	10
01 001 040	Cilindro cm 40	40	10

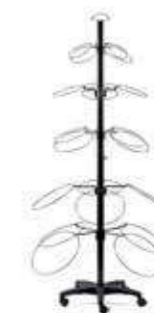

Espositore sottovasi

Codice ESPOSITORE SOTTOVASI:

Code for Saucer Display:

Code du présentoir pour les Soucoupes:

Kode für Untersetzerständer:

10909830000

L'espositore è adatto per contenere il nostro articolo SOTTOVASO ROTONDO INIEZIONE nelle seguenti misure e quantità:

The Display is suitable to hold our article ROUND SAUCER INJECTION in the following sizes and quantities:

Le présentoir est apte à contenir notre article SOUCOUBE RONDE INJECTÉE dans les tailles et quantités suivantes:

Der Präsentationsständer ist für unseren Artikel INJEKTION UNTERSETZER RUND in den folgenden Größen und Mengen als Behälter geeignet:



codice senza colore code without colour	descrizione	quantità totale consigliata	minimo vendita per colore
01 011 012	Sottovaso cm 12	100	100
01 011 014	Sottovaso cm 14	100	100
01 011 016	Sottovaso cm 16	100	100
01 011 018	Sottovaso cm 18	50	100
01 011 020	Sottovaso cm 20	50	50
01 011 022	Sottovaso cm 22	50	50
01 011 024	Sottovaso cm 24	50	50
01 011 026	Sottovaso cm 26	50	50
01 011 028	Sottovaso cm 28	50	50
01 011 030	Sottovaso cm 30	50	25
01 011 035	Sottovaso cm 35	50	25
01 011 040	Sottovaso cm 40	50	25
01 011 045	Sottovaso cm 45	50	25
01 011 052	Sottovaso cm 52	50	25



Teraplast Marketing support

Teraplast può aiutarti anche per quanto riguarda il punto vendita, offrendo una grande varietà di display e scaffalature espositive. Sono soluzioni ideali perché sono maneggevoli e attrattive per il consumatore finale.

Teraplast Marketing support

Teraplast may help you also concerning shops, offering a wide range of display solutions and shelves. They are ideal solutions, because they are manageable and eye catching for consumers.



Teraplast Marketing support

Teraplast kann Ihnen auch im Shop mit einer Vielzahl von Displays und Ausstellungsregale behilflich sein. Es handelt sich um ideale Lösungen, die einfach zu handhaben sind und für den Endverbraucher anziehend wirken.

Teraplast Marketing support

Au niveau de point de vente Teraplast peut vous aider avec une grande variété de display et présentoirs. Il s'agit de solutions idéales car elles sont faciles à utiliser et attrayant pour le consommateur finale



Un prodotto presentato con **gusto e chiarezza** è un prodotto che comunica **qualità**.

La presentazione delle famiglie di prodotti insieme, coordinati nei colori e nello stile, comunica un marchio forte e affidabile.

I nostri display pallet sono ideali per proporre nuove e interessanti combinazioni di colori.

A **tasteful and clear** product is a product which conveys **quality**.

The presentation of coordinate products in terms of colours improves its visual impact and increases pulse purchases.

Our display pallet are flexible solution suitable for several promotions.



Le produit qui est présenté avec **bon goût et clarté** est un produit qui communique la **qualité**.

La présentation des produits coordonnés en rapport aux couleurs renforce l'impact visuel du produit et il augmente les achats d'impulsion.

Nos palettes display offrent des solutions flexibles et adaptées à nombreux promotions.

Ein Produkt das **gut** und in einer **geordneten Art** präsentiert wird betont auch die **Qualität**.

Die Ausstellung der Produkte mit gut aufeinander abgestimmte Farben hat optisch einen positiven Einfluss und erhöht die Impulskaufe.

Unsere Displaypaletten sind flexible Lösungen die sich gut für Promotionen eignen.



TeraPlast Marketing support

Scaffali supporto alla vendita
Exhibition shelves
Support à la vente
Regale zur Verkaufsunterstützung

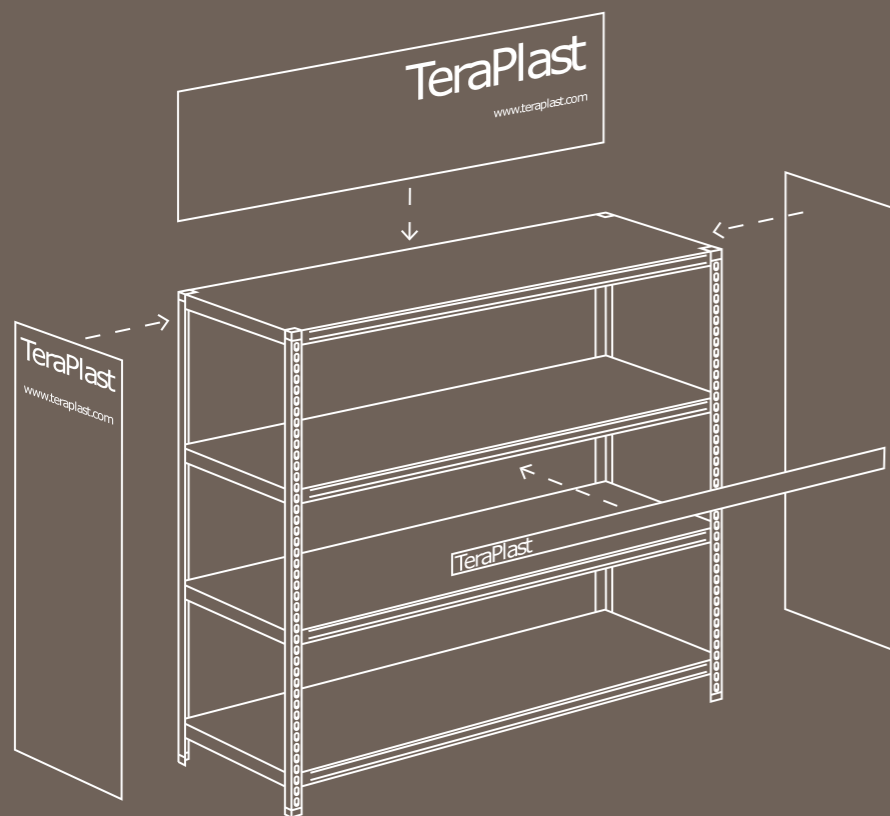

60 cm

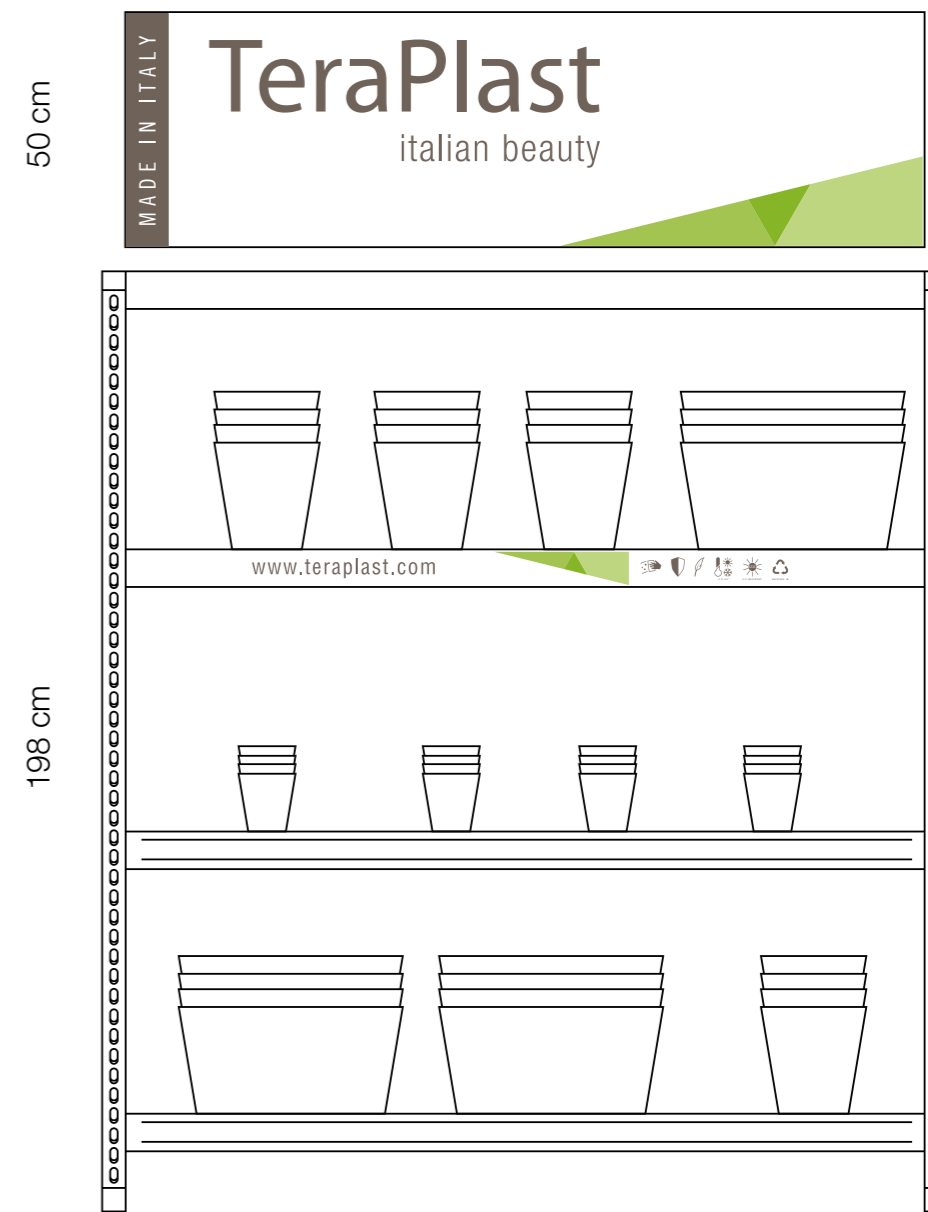

50 cm

198 cm

187 cm

display kit balcone **Mare** 1 pz



022
bianco/white
blanc/weiß

403
corda/cord
corde/seil

406
bruno/brown
brun/braun

408
cacao/cocoa
cacao/kakao



018
ciclaminò/cyclamen
cyclamen/zyklamfarbe

019
lilla/lilac
lilas/lila

404
cedro/cedar
cèdre/zeder



001
terracotta/terracotta colour
couleur terre/farbe terrakotta

005
antracite/anthracite
anthracite/anthrazitgrau

codice senza colore code without colour	Cm	dimensioni dimensions	pezzi pallet pcs pallet	m ³
01 015 040 022 403 406 408 018 019 404 001 005	40	a40 b17 c14,5	48	80x120x115h 1,10
01 015 050 022 403 406 408 018 019 404 001 005	50	a50 b17 c14,5	42	80x120x115h 1,10
01 015 060 022 403 406 408 018 019 404 001 005	60	a60 b17 c14,5	35	80x120x115h 1,10
01 015 080 403 406 408 001 005	80	a80 b17 c14,5	24	80x120x105h 1,10

display kit balcone **Mare** 2 pz



022
bianco/white
blanc/weiß

403
corda/cord
corde/seil

406
bruno/brown
brun/braun

408
cacao/cocoa
cacao/kakao



018
ciclaminò/cyclamen
cyclamen/zyklamfarbe

019
lilla/lilac
lilas/lila

404
cedro/cedar
cèdre/zeder



001
terracotta/terracotta colour
couleur terre/farbe terrakotta

005
antracite/anthracite
anthracite/anthrazitgrau

codice senza colore code without colour	Cm	dimensioni dimensions	pezzi pallet pcs pallet	m ³
01 019 040 022 403 406 408 018 019 404 001 005	40	a40 b17 c14,5	40	80x120x115h 1,10
01 019 050 022 403 406 408 018 019 404 001 005	50	a50 b17 c14,5	35	80x120x115h 1,10
01 019 060 022 403 406 408 018 019 404 001 005	60	a60 b17 c14,5	25	80x120x115h 1,10
01 019 080 403 406 408 001 005	80	a80 b17 c14,5	18	80x120x115h 1,10



T-BASKET



T-Basket



T-Basket Big



ideale per contenere
3 vasi da 14 cm
Ideal for containing
3 pots of 14 cms
Idéal pour contenir 3
vases à 14 cm
Ideal um 3 Vasen à
14cm zu fassen

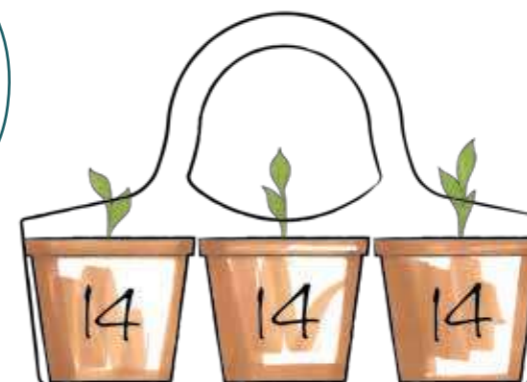

Linea Flortec
pagina 189



022
bianco/white
blanc/weiß



010
rosso/red
rouge/rot



402
lilyum/lilyum
lilyum/lilyum



404
cedro/cedar
cèdre/zeder



406
bruno/brown
brun/braun

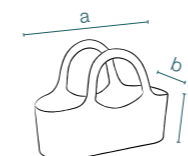

codice senza colore code without colour	Cm	dimensioni dimensions	pezzi pallet pcs pallet	m ³
BOX 1 COLOUR	26 101 000	a43 b18 c31	10	44x18x55h 0,043
BIG BOX	26 101 000	a48 b18 c31	78	57x50x103h 0,293



Superficie opaca
Matt finished
Surface opaque
Matt-Oberfläche



T-Basket



022
bianco/white
blanc/weiß



010
rosso/red
rouge/rot



419
giallo/yellow
jaune/gelb



402
lilyum/lilyum
lilyum/lilyum



404
cedro/cedar
cèdre/zeder



415
terra di Siena/terra di siena
terra di siena/terra di siena

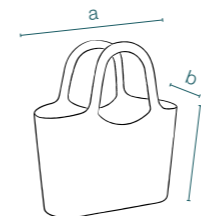

codice senza colore code without colour	Cm	dimensioni dimensions	pezzi pallet pcs pallet	m ³
BOX 1 COLOUR	26 102 000	a48 b18 c51	6	44x18x55h 0,043
BIG BOX	26 102 000	a48 b18 c51	63	57x50x103h 0,293



Superficie opaca
Matt finished
Surface opaque
Matt-Oberfläche



T-Basket big



linea
FLOORTEC



Norma



Container



Crisa



Basso

vaso Norma



001
terracotta/terracotta colour
couleur terre/farbe terrakotta



003
nero/black
noir/schwarz

A richiesta sono disponibili altri colori
Further colours are available on demand
D'autres couleurs sont disponibles sur demande
Weiteren Farben sind auf Anforderung vorrätig



010
rosso/red
rouge/rot



013
giallo/yellow
jaune/gelb



015
azzurro/light blue
azur/hellblau



016
arancio/orange
orange/orange



018
ciclamino/cyclamen
cyclamen/zyklamfarbe



019
lilla/lilac
lilas/lila



404
cedro/cedar
cèdre/zeder

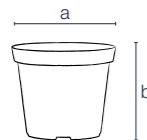

codice senza colore code without colour	Cm	colori colour	colori a richiesta colours on request	dimensioni dimensions	litri liters	pz/conf pcs/pack	Pcs Pit
03 300 008	8	001 003	010 013 015 016 018 019 404	a8 b6,8	0,2	2275	36400
03 300 010	10	001 003	010 013 015 016 018 019 404	a10 b7,7	0,38	1610	25760
03 300 011	11	001 003	010 013 015 016 018 019 404	a11 b8,8	0,53	1188	19008
03 300 012	12	001 003	010 013 015 016 018 019 404	a12 b10	0,72	915	14640
03 300 013	13	001 003	010 013 015 016 018 019 404	a13 b11	0,94	840	13440
03 300 014	14	001 003	010 013 015 016 018 019 404	a14 b12	1,25	671	10736
03 300 015	15	001 003	010 013 015 016 018 019 404	a15 b13	1,51	495	7920
03 300 016	16	001 003	010 013 015 016 018 019 404	a16 b12,2	1,79	360	5760
03 300 018	18	001 003	010 013 015 016 018 019 404	a18 b13,6	2,61	300	4800

Flortec Special Packaging



We can provide to our customers a wide range of **special packaging**.

Nous pouvons vous fournir une large gamme d'**emballages spéciaux**.

Lieferung in **Sonderverpackungen** möglich.

Siamo in grado di fornirvi un'ampia gamma di **imballi speciali**.

vaso **Container**



001

terracotta/terracotta colour
couleur terre/farbe terrakotta



003

nero/black
noir/schwarz

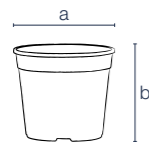

codice senza colore code without colour	Cm	colori colour	colori a richiesta colours on request	dimensioni dimensions	litri liters	pz/conf pcs/pack	Pcs Pit
03 301 015	15	001 003		a15 b13	1,63	423	6768
03 301 019	19	001 003	010 013 015 016 018 019 404	a19 b17,4	3,43	186	2976

vaso **Basso**



001

terracotta/terracotta colour
couleur terre/farbe terrakotta



003

nero/black
noir/schwarz

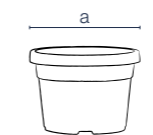

codice senza colore code without colour	Cm	colori colour	dimensioni dimensions	litri liters	pz/conf pcs/pack	Pcs Pit
03 303 017	17	001 003	a17 b12	1,74	192	3072

vaso **Crisa**



001

terracotta/terracotta colour
couleur terre/farbe terrakotta

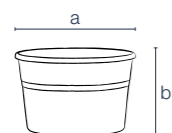

codice senza colore code without colour	Cm	colori colour	dimensioni dimensions	litri liters	pz/conf pcs/pack	Pcs Pit
03 304 022	22	001	a22 b15	3,31	140	2240

Gabbia verde



002

verde/green
vert/grün

codice senza colore code without colour	Cm	colori colour	dimensioni dimensions	pz/conf pcs/pack	Pcs Pit
03 302 014	14	002	a14 b22	240	4800



linea
ESSENTIAL

- | | | | | |
|---|---|---|--|---|
|  |  |  |  |  |
| Schio Sottocubo | Schio
Cubo Basso | Schio Cubo Alto | Avila | Ribeira |
|  |  |  |  |  |
| Jardinera Veneto | Tondo Veneto | Schio Cassa Alta | Schio Cono | Schio Ciotola |

- | | | | | |
|---|---|---|---|---|
|  |  |  |  |  |
| Divio | Corner | Schio Cassa | Schio Sottocassa | Schio Cubo |
|  |  |  |  |  |
| Zamora | Leon | Standard One | Quadro Veneto | Cassa Veneto |
|  |  |  |  |  |
| Pasubio Alto | Pasubio Quadro | Pasubio Cassa | Valentino | Bassano |



Divio indoor



043

bianco/white
blanc/weiß



201

cappuccino/cappuccino
cappuccino/cappuccino



210

grafite/graphite
graphite/graphit



232

kiwi/kiwi
kiwi/Kiwi

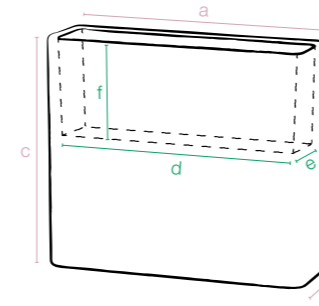

codice senza colore code without colour	Cm	dimensioni esterne external dimensions	dimensioni interne internal dimensions	litri liters	Confezione minima Minimum package	m ³	pezzi pallet pcs pallet	m ³
11 466 080	80	a:90 b:27 c:77	d:85 e:21 f:33	59	1 91x28x79h	0,2	8 80x120x201h	1,93

Corner indoor



043

bianco/white
blanc/weiß



201

cappuccino/cappuccino
cappuccino/cappuccino



210

grafite/graphite
graphite/graphit



232

kiwi/kiwi
kiwi/Kiwi

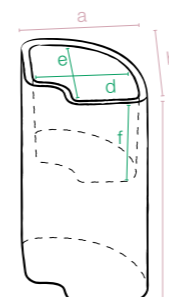

codice senza colore code without colour	Cm	dimensioni esterne external dimensions	dimensioni interne internal dimensions	litri liters	Confezione minima Minimum package	m ³	pezzi pallet pcs pallet	m ³
11 467 080	80	a:39 b:39 c:77	d:22 e:34 f:33	26	1 40x40x79h	0,1	15 80x120x213h	2,04



Superficie opaca
Matt finished
Surface opaque
Matt-Oberfläche



Divio e Corner

Divio + Corner
componibili
modular
modulable
zusammensetzbar

permettono diverse combinazioni
 allow various combinations
 ils permettent différentes combinaisons
 Divio und Corner ermöglichen viele Zusammenstellungen

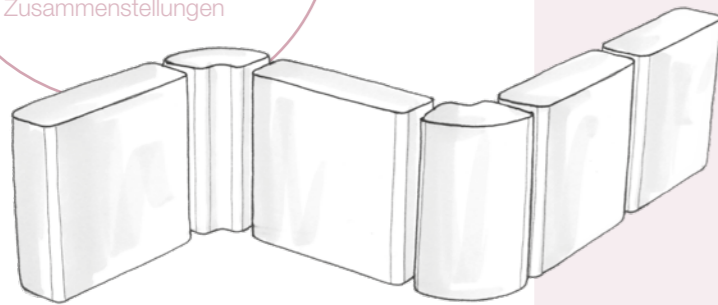

in base all'ambiente
 depending on the environment
 en fonction de l'environnement
 nach dem Raum

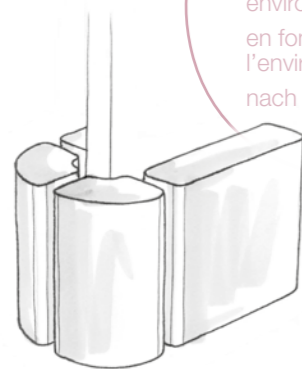

Divio e Corner si prestano molto bene per organizzare gli spazi

DIVIO and CORNER lend very well to organize spaces

Divio et Corner se prêtent très bien pour l'organisation des espaces

Divio und Corner sind ideal für die Teilung der Räume

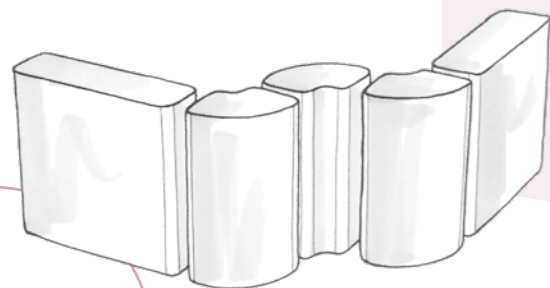

e alla vostra fantasia
 and to your imagination
 et à votre imagination
 und Ihrer Fantasie

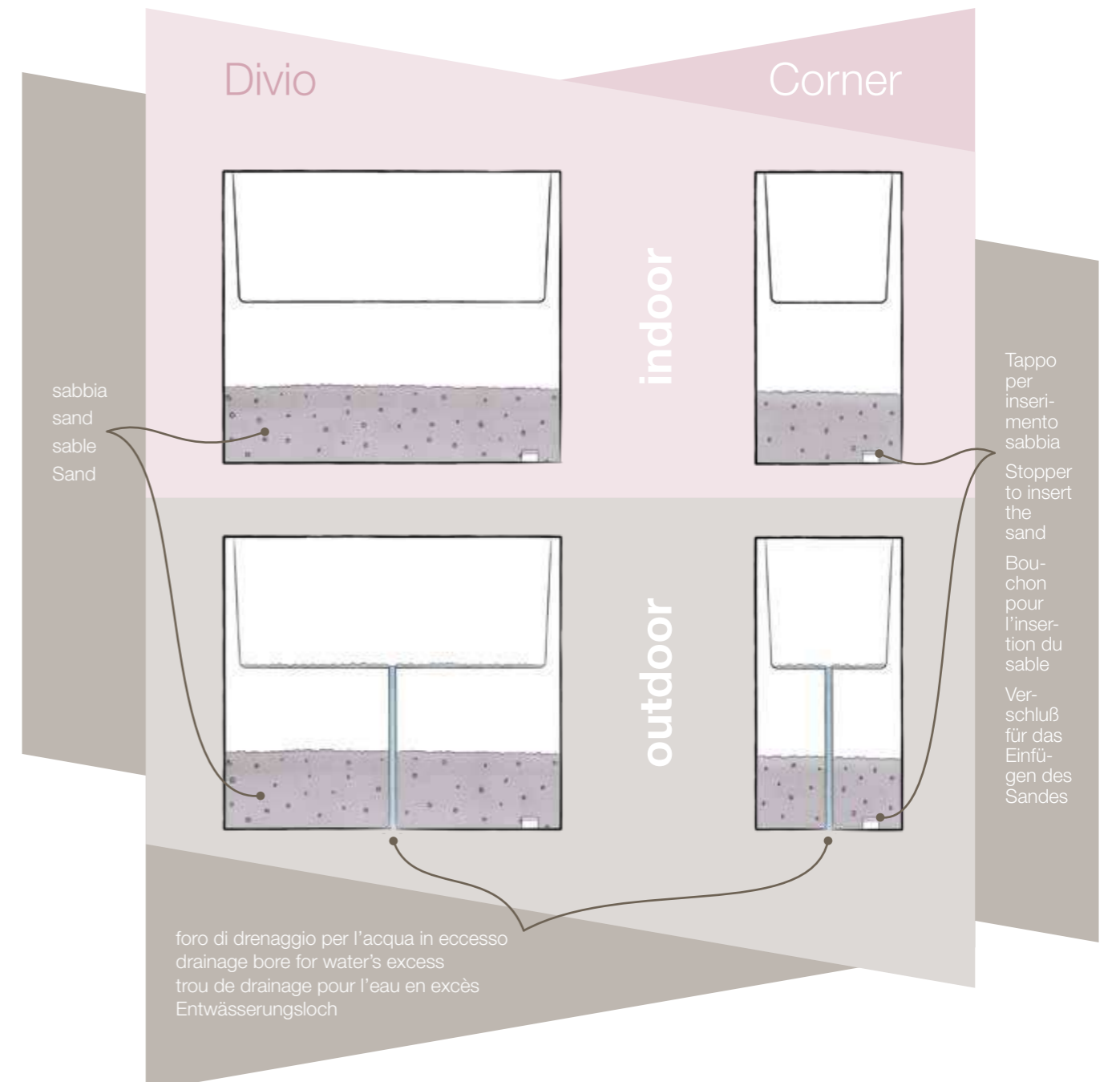
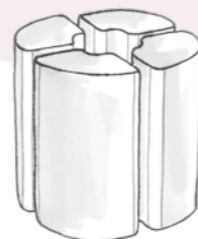

Divio outdoor

codice senza colore code without colour	Cm	dimensioni esterne external dimensions	dimensioni interne internal dimensions	litri liters	Confezione minima Minimum package	m ³	pezzi pallet pcs pallet	m ³			
15 466 080	043 201 210 232	80	a90 b27 c77	d85 e21 f33	59	1	91x28x79h	0,2	8	80x120x201h	1,93

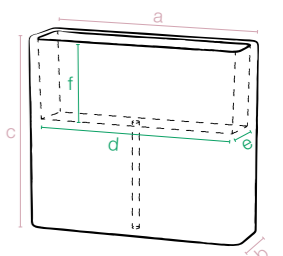

Corner outdoor

codice senza colore code without colour	Cm	dimensioni esterne external dimensions	dimensioni interne internal dimensions	litri liters	Confezione minima Minimum package	m ³	pezzi pallet pcs pallet	m ³			
15 467 080	043 201 210 232	80	a39 b39 c77	d22 e34 f33	26	1	40x40x79h	0,1	15	80x120x213h	2,04

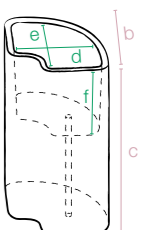

Schio cassa



Superficie opaca
Matt finished
Surface opaque
Matt-Oberfläche



043
bianco/white
blanc/weiß



201
cappuccino/cappuccino
cappuccino/cappuccino



032
antracite/anthracite
anthracite/anthrazitgrau



050
rosso cardinale/cardinal red
rouge cardinal/scharlachrot



039
bronzo/bronze
bronze/bronze

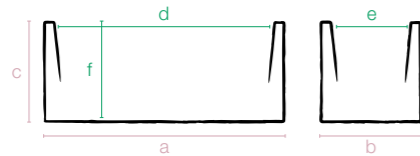

codice senza colore code without colour	Cm	dimensioni esterne external dimensions			dimensioni interne internal dimensions			litri liters	Confezione minima Minimum package	m ³	pezzi pallet pcs pallet	m ³
11 427 060	60	a60	b25	c25	d54	e20	f25	26	2 60x25x50h	0,07	24 80x120x115h	1,10
11 427 080	80	a80	b30	c30	d73	e24	f30	51	2 80x30x30h	0,07	28 80x120x222h	2,13
11 427 100	100	a100	b40	c40	d90	e30	f40	108	1 100x40x40h	0,16	10 80x120x210h	2,52
11 427 120	120	a115	b50	c50	d103	e38	f50	195	1 115x50x50h	0,28	8 100x120x220h	2,53

Schio sottocassa



Schio cassa
+
Schio sottocassa



043
bianco/white
blanc/weiß



201
cappuccino/cappuccino
cappuccino/cappuccino



032
antracite/anthracite
anthracite/anthrazitgrau



050
rosso cardinale/cardinal red
rouge cardinal/scharlachrot



039
bronzo/bronze
bronze/bronze

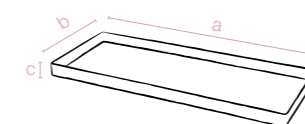

codice senza colore code without colour	Cm	dimensioni esterne external dimensions			Confezione minima Minimum package	m ³
11 479 080	80	a80	b30	c4	2 80x30x8h	0,02
11 479 100	100	a101	b41	c5,5	1 101x41x5,5h	0,02



Schio cubo



Superficie opaca
Matt finished
Surface opaque
Matt-Oberfläche



043
bianco/white
blanc/weiß



201
cappuccino/cappuccino
cappuccino/cappuccino



032
antracite/anthracite
anthracite/anthrazitgrau



050
rosso cardinale/cardinal red
rouge cardinal/scharlachrot



039
bronzo/bronze
bronze/bronze

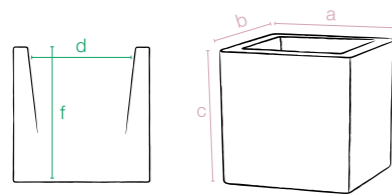

codice senza colore code without colour	Cm	dimensioni esterne external dimensions			dimensioni interne internal dimensions			litri liters	Confezione minima Minimum package	m ³	pezzi pallet pcs pallet	m ³
11 425 025	25	a25	b25	c25	d19,5	e19,5	f24	9	1 25x25x25h	0,01	48 80x120x115h	0,55
11 425 030	30	a30	b30	c30	d23,5	e23,5	f28	15	1 30x30x30h	0,02	24 80x120x115h	1,10
11 425 040	40	a40	b40	c40	d30	e30	f38	34	1 40x40x40h	0,06	12 80x120x92h	0,88
11 425 050	50	a50	b50	c50	d38	e38	f38	55	1 50x50x50h	0,12	8 100x120x112h	1,34
11 425 060	60	a58	b58	c58	d45	e45	f58	117	1 58x58x58h	0,19	6 80x120x200h	1,92

Schio cubo + Schio sottocubo



043
bianco/white
blanc/weiß



201
cappuccino/cappuccino
cappuccino/cappuccino



032
antracite/anthracite
anthracite/anthrazitgrau



050
rosso cardinale/cardinal red
rouge cardinal/scharlachrot



039
bronzo/bronze
bronze/bronze

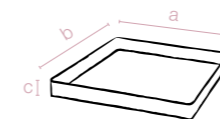

codice senza colore code without colour	Cm	dimensioni esterne external dimensions			Confezione minima Minimum package	m ³
11 480 040	40	a40	b40	c5,5	1 40x40x5,5h	0,01

Schio sottocubo



Schio

cubo basso



Superficie opaca
Matt finished
Surface opaque
Matt-Oberfläche



043

bianco/white
blanc/weiß



201

cappuccino/cappuccino
cappuccino/cappuccino



032

antracite/anthracite
anthracite/anthrazitgrau



050

rosso cardinale/cardinal red
rouge cardinal/scharlachrot



039

bronzo/bronze
bronze/bronze



Schio

cubo alto



Superficie opaca
Matt finished
Surface opaque
Matt-Oberfläche



043

bianco/white
blanc/weiß



201

cappuccino/cappuccino
cappuccino/cappuccino



032

antracite/anthracite
anthracite/anthrazitgrau



050

rosso cardinale/cardinal red
rouge cardinal/scharlachrot



039

bronzo/bronze
bronze/bronze

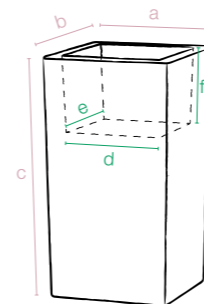

codice senza colore code without colour	Cm	dimensioni esterne external dimensions	dimensioni interne internal dimensions	litri liters	Confezione minima Minimum package	m ³	pezzi pallet pcs pallet	m ³	accessori accessories
11 426 080	80	a40 b40 c80	d30 e30 f20	31	1 40x40x80h	0,07	15 80x120x215h	1,10	

Fix Ground
Fix Wall
pagina 272

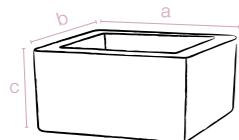

codice senza colore code without colour	Cm	dimensioni esterne external dimensions	dimensioni interne internal dimensions	litri liters	Confezione minima Minimum package	m ³	pezzi pallet pcs pallet	m ³
11 456 050	50	a50 b50 c20	d40 e40 f19	26	1 50x50x20h	0,05	14 80x120x115h	0,55



Schio family
componibile
modular
modulable
zusammensetzbar

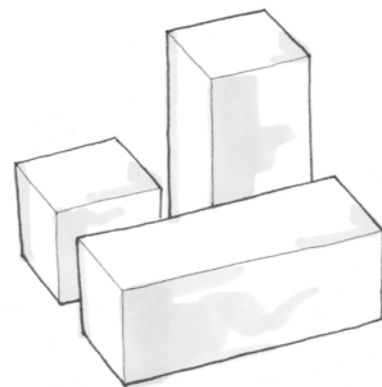
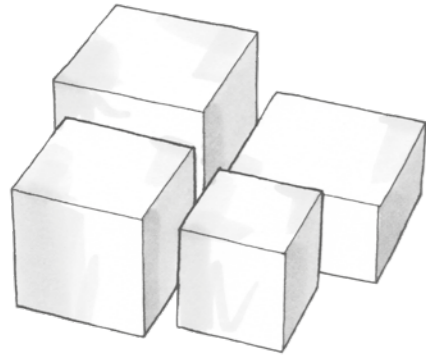

“Semplicemente accostando 3 vasi
ho dato un ordine al mio giardino”

“By simply approaching 3 pots I gave
an order to my garden.”

“En approchant simplement 3 pots
j’ai donné un ordre à mon jardin”

“Ich habe 3 Töpfe zusammengestellt
und mein Garten sieht gepflegter aus”

Alessandra

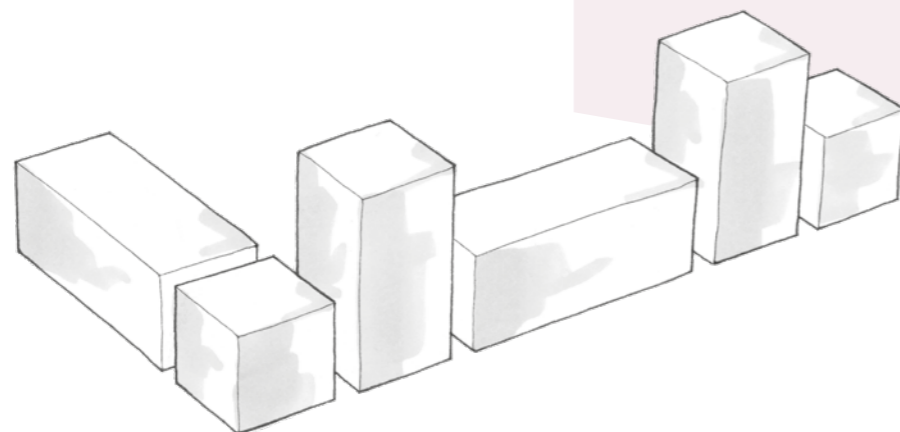

Schio cubo, Schio cubo alto e
Schio cassa si prestano molto
bene per organizzare gli spazi

Schio cubo, Schio cubo alto
and Schio cassa lend very
well to organize spaces

Schio Cubo, Cubo Alto et
Cassa se prêtent très bien
pour l’organisation des
espaces

Schio Cubo, Schio Cubo Alto
und Schio Cassa sind ideal für
die Organization der Räume

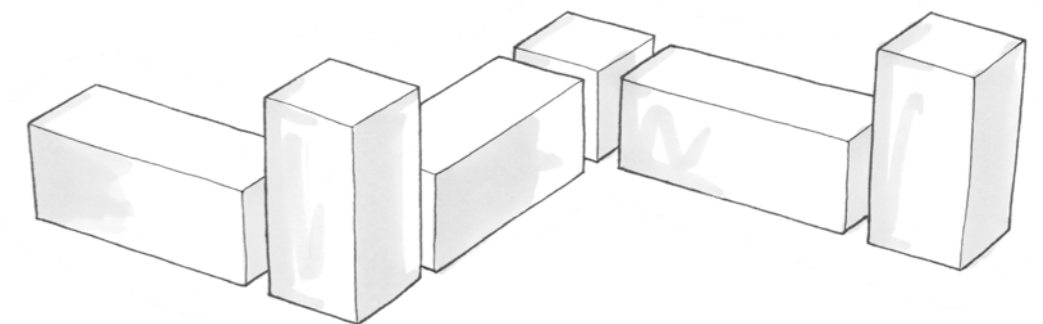
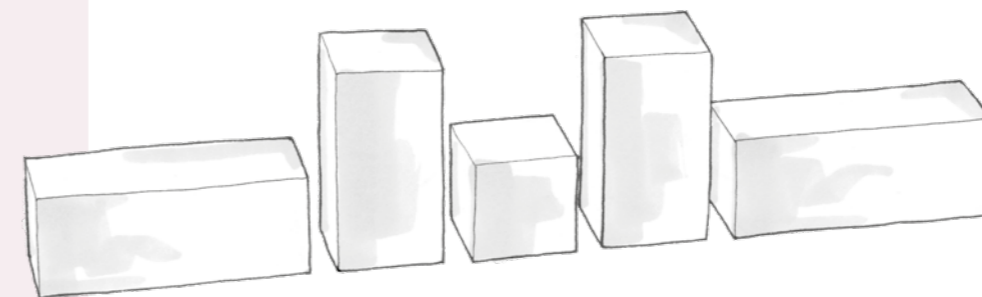



043
bianco/white
blanc/weiß



204
grigio seta/silk grey
grise soie/grauer Seide



201
cappuccino/cappuccino
cappuccino/cappuccino



032
antracite/anthracite
anthracite/anthrazitgrau



233
toffee/toffee
caramel/Toffee



202
lavanda/lavender
lavande/lavendel



068
fucsia/fuchsia
fuchsia/fuchsiensfarbig



232
kiwi/kiwi
kiwi/Kiwi



Superficie opaca
Matt finished
Surface opaque
Matt-Oberfläche



Avila

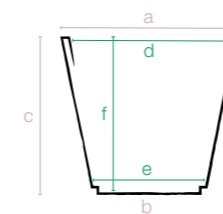

codice senza colore code without colour	Cm	dimensioni esterne external dimensions	dimensioni interne internal dimensions	litri liters	Confezione minima Minimum package	m ³	pezzi pallet pcs pallet	m ³
11 470 035	35	a33 b18 c30	d30 e17 f29	19	1 33x33x28h	0,03	66 80x120x115h	1,10
11 470 040	40	a38 b25 c32	d38 e25 f32	29	1 38x38x33h	0,04	54 80x120x115h	1,10
11 470 050	50	a49 b32 c42	d49 e32 f42	44	1 49x49x42h	0,10	32 80x120x115h	1,10



043
bianco/white
blanc/weiß



204
grigio seta/silk grey
grise soie/grauer Seide



201
cappuccino/cappuccino
cappuccino/cappuccino



032
antracite/anthracite
anthracite/anthrazitgrau



039
bronzo/bronze
bronze/bronze



233
toffee/toffee
caramel/Toffee



202
lavanda/lavender
lavande/lavendel



068
fucsia/fuchsia
fuchsia/fuchsiensfarbig



232
kiwi/kiwi
kiwi/Kiwi



Sottovaso
pagina 248

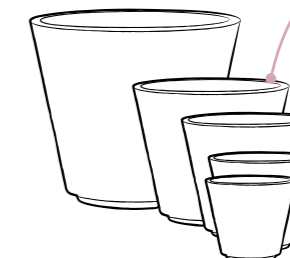

5 misure
5 sizes
5 mesures
5 Größen

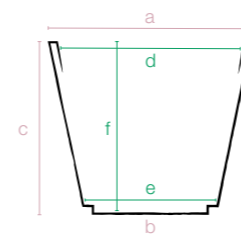

codice senza colore code without colour	Cm	dimensioni esterne external dimensions	dimensioni interne internal dimensions	litri liters	Confezione minima Minimum package	m ³	pezzi pallet pcs pallet	m ³
11 461 035	35	a33 b18,5 e29	d30 e18,5 f28	13	2 33x33x37h	0,04	63 80x120x115h	1,10
11 461 040	40	a38 b21,5 e35	d34,5 e21,5 f34	21	2 38x38x43h	0,06	114 80x120x230h	2,21
11 461 050	50	a49 b27,5 e43	d44,5 e27,5 f42	44	33 49x49x42h	0,10	64 100x120x230h	2,65
11 461 060	60	a57 b32 e49	d52 e32 f49	78	47 57x57x49h	0,15	28 80x120x220h	2,11
11 461 080	80	a77 b43 e65	d70 e43 f65	191	54 77x77x65h	0,38	10 80x80x220h	1,40



Superficie opaca
Matt finished
Surface opaque
Matt-Oberfläche



Ribeira



043
bianco/white
blanc/weiß



204
grigio seta/silk grey
grise soie/grauer Seide



201
cappuccino/cappuccino
cappuccino/cappuccino



068
fucsia/fuchsia
fuchsia/fuchsienfarbig



232
kiwi/kiwi
kiwi/Kiwi



202
lavanda/lavender
lavande/lavendel



032
antracite/anthracite
anthracite/anthrazitgrau



Sottovaso
pagina 248

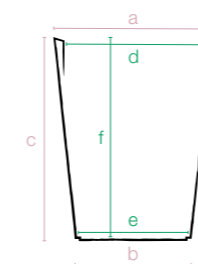

codice senza colore code without colour	Cm	dimensioni esterne external dimensions			dimensioni interne internal dimensions			litri liters		Confezione minima Minimum package	m ³	pezzi pallet pcs pallet	m ³
11 465 043	43	a33	b24	c42	d29	e24	f42	24	27	1 33x24x42h	0,03	96	80x120x225h 2,16
11 465 050	50	a39	b28,5	c50	d35	e28	f49	45	30	1 39x28,5x50h	0,30	60	80x120x215h 2,06
11 465 065	65	a49	b36	c66	d44	e35	f61	94	47	1 49x36x66h	0,10	21	80x120x210h 2,02



Superficie opaca
Matt finished
Surface opaque
Matt-Oberfläche



Zamora



043
bianco/white
blanc/weiß



201
cappuccino/cappuccino
cappuccino/cappuccino



032
antracite/anthracite
anthracite/anthrazitgrau

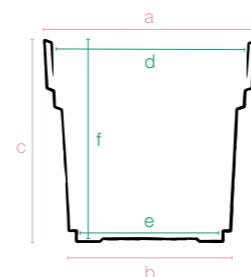

codice senza colore code without colour	Cm	dimensioni esterne external dimensions	dimensioni interne internal dimensions	litri liters	Confezione minima Minimum package	m ³	pezzi pallet pcs pallet	m ³
11 471 035	35	a33 b25,5 c33	d29 e23 f33	9	1 33x33x33h	0,03	63 80x120x115h	1,10
11 471 040	40	a38 b30 c38	d35 e26 f38	15	1 38x38x38h	0,05	48 80x120x115h	1,10



Superficie opaca
Matt finished
Surface opaque
Matt-Oberfläche



Leon



adatto anche per uso esterno
also suitable for outdoor use
également adapté pour une utilisation en extérieur
Outdoor geeignet



043
bianco/white
blanc/weiß



204
grigio seta/silk grey
grise soie/grauer Seide



201
cappuccino/cappuccino
cappuccino/cappuccino



030
antico/light brown
marron clair/hellbraun



039
bronzo/bronze
bronze/bronze



050
rosso cardinale/cardinal red
rouge cardinal/scharlachrot



232
kiwi/kiwi
kiwi/Kiwi



202
lavanda/lavender
lavande/lavendel



032
antracite/anthracite
anthracite/anthrazitgrau



Sottovaso
pagina 248

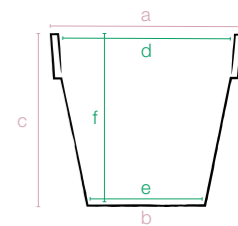

codice senza colore code without colour	Cm	dimensioni esterne external dimensions			dimensioni interne internal dimensions			litri liters	Confezione minima Minimum package	m ³	pezzi pallet pcs pallet	m ³
11 437 030	30	a30	b18,5	c27	d26,5	e18,5	f27	11	22	4 30x30x48h	0,04	88 80x120x115h 1,10
11 437 040	40	a40	b25	c35	d36	e25	f35	26	30	2 40x40x46h	0,07	48 80x120x112h 1,08
11 437 050	50	a50	b31	c43	d44	e31	f43	48	37	2 50x50x58h	0,14	64 100x120x226h 2,71
11 437 060	60	a60	b37	c54	d53	e37	f53	85	47	2 60x60x70h	0,25	22 80x120x215h 2,06
11 437 070	70	a70	b43	c63	d61	e43	f62	133	50	1 70x70x63h	0,30	9 80x80x215h 1,38
11 437 080	80	a80	b49	c72	d70	e49	f71	199	60	1 80x80x72h	0,46	8 80x80x220h 1,41
11 437 100	100	a100	b61	c90	d88	e61	f90	396	66	1 100x100x90h	0,90	6 100x120x225h 2,70
11 437 120	120	a120	b74	c108	d105	e74	f108	686	-	1 120x120x108h	1,29	4 120x120x215h 3,10
11 437 140	140	a140	b86	c126	d123	e86	f126	1079	-	1 140x140x207h	2,46	3 140x140x207h 4,05



Superficie opaca
Matt finished
Surface opaque
Matt-Oberfläche



**Standard
one**

quadro Veneto



Superficie opaca
Matt finished
Surface opaque
Matt-Oberfläche



cassa Veneto



Superficie opaca
Matt finished
Surface opaque
Matt-Oberfläche



043
bianco/white
blanc/weiß



201
cappuccino/cappuccino
cappuccino/cappuccino



039
bronzo/bronze
bronze/bronze



032
antracite/anthracite
anthracite/anthrazitgrau



043
bianco/white
blanc/weiß



201
cappuccino/cappuccino
cappuccino/cappuccino



039
bronzo/bronze
bronze/bronze



032
antracite/anthracite
anthracite/anthrazitgrau

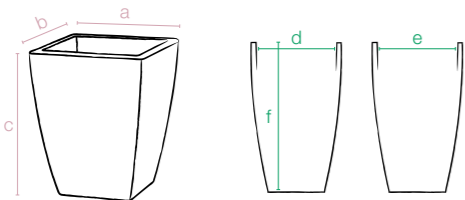

Sottovaso
pagina 249

codice senza colore code without colour	Cm	dimensioni esterne external dimensions			dimensioni interne internal dimensions			litri liters	Confezione minima Minimum package	m ³	pezzi pallet pcs pallet	m ³
11 407 035	35	a29	b29	c36	d25	e25	f36	17	30	2 29x29x57h	0,04	32 80x120x115h 1,10
11 407 040	40	a33	b33	c41	d28,5	e28,5	f41	25	30	2 33x33x66h	0,07	48 80x120x230h 2,21
11 407 050	50	a40	b40	c50	d34	e34	f50	44	36	2 40x40x78h	0,12	42 80x120x228h 2,19
11 407 060	60	a49	b49	c61	d42	e42	f61	83	40	2 49x49x61h	0,14	20 100x120x230h 2,65
11 407 065	65	a40	b40	c65	d34	e34	f65	56	36	2 40x40x107h	0,17	30 80x120x238h 2,28

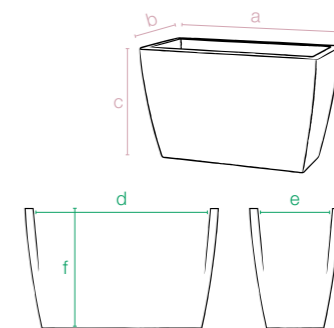

codice senza colore code without colour	Cm	dimensioni esterne external dimensions			dimensioni interne internal dimensions			litri liters	Confezione minima Minimum package	m ³	pezzi pallet pcs pallet	m ³
11 438 080	80	a80	b40	c50	d74	e35	f50	169	2 80x40x80h	0,25	18 80x120x228h 2,19	



jardinera Veneto



Superficie opaca
Matt finished
Surface opaque
Matt-Oberfläche



tondo Veneto



Superficie opaca
Matt finished
Surface opaque
Matt-Oberfläche



043

bianco/white
blanc/weiß



201

cappuccino/cappuccino
cappuccino/cappuccino



032

antracite/anthracite
anthracite/anthrazitgrau



039

bronzo/bronze
bronze/bronze

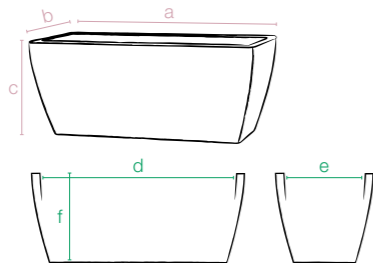

codice senza colore code without colour	Cm	dimensioni esterne external dimensions			dimensioni interne internal dimensions			litri liters	Confezione minima Minimum package	m ³	pezzi pallet pcs pallet	m ³
11 460 058	58	a58	b29	c25	d54	e25	f25	43	2 58x29x41h	0,06	52	80x120x230h 2,21
11 460 066	66	a66	b33	c28	d62	e29	f28	68	2 66x33x46h	0,10	33	80x120x230h 2,21
11 460 080	80	a79	b39	c33	d73	e33	f33	107	2 79x39x54h	0,16	27	80x120x230h 2,21



043

bianco/white
blanc/weiß



201

cappuccino/cappuccino
cappuccino/cappuccino



032

antracite/anthracite
anthracite/anthrazitgrau



039

bronzo/bronze
bronze/bronze

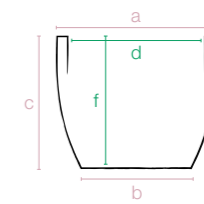

codice senza colore code without colour	Cm	dimensioni esterne external dimensions			dimensioni interne internal dimensions			litri liters	Confezione minima Minimum package	m ³	pezzi pallet pcs pallet	m ³
11 448 032	32	a32	b21	c27	d26	f25	11	2 32x32x48h	0,04	64	80x120x232h 2,23	
11 448 042	42	a42	b28	c35	d35	f33	26	2 42x42x63h	0,11	36	80x120x222h 2,13	
11 448 052	52	a52	b36	c43	d43	f40	49	2 52x52x80h	0,21	15	80x120x227h 2,72	
11 448 062	62	a62	b36	c50	d50	f44	64	2 62x62x88h	0,33	10	80x120x207h 1,99	



Schio

cassa alta



Superficie opaca
Matt finished
Surface opaque
Matt-Oberfläche



Schio

cono



Superficie opaca
Matt finished
Surface opaque
Matt-Oberfläche



043

bianco/white
blanc/weiß



201

cappuccino/cappuccino
cappuccino/cappuccino



032

antracite/anthracite
anthracite/anthrazitgrau



050

rosso cardinale/cardinal red
rouge cardinal/scharlachrot



043

bianco/white
blanc/weiß



201

cappuccino/cappuccino
cappuccino/cappuccino



032

antracite/anthracite
anthracite/anthrazitgrau



050

rosso cardinale/cardinal red
rouge cardinal/scharlachrot



039

bronzo/bronze
bronze/bronze

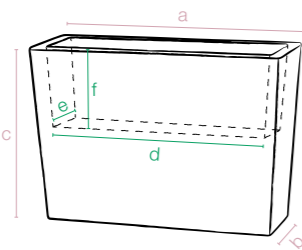

codice senza colore code without colour	Cm	dimensioni esterne external dimensions	dimensioni interne internal dimensions	litri liters	Confezione minima Minimum package	m³	pezzi pallet pcs pallet	m³
11 428 050	50	a50 b35 c69	d40 e26 f30	31	1 50x40x70h	0,14	12 80x120x222h	2,13
11 428 100	100	a100 b35 c69	d90 e26 f30	70	1 100x40x70h	0,28	6 80x120x222h	2,13

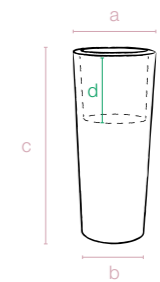

codice senza colore code without colour	Cm	dimensioni dimensions	litri liters	Confezione minima Minimum package	m³	pezzi pallet pcs pallet	m³	accessori accessoires
11 424 070	70	a30 b23 c68 d20	8	1 30x30x68h	0,06	24 80x120x225h	2,16	
11 424 090	90	a40 b29,5 c90 d26	26	1 40x40x90h	0,14	12 80x120x195h	1,87	
11 424 110	110	a45 b34,5 c110 d28	35	1 45x45x110h	0,22	12 80x120x236h	2,27	
11 424 145	145	a55 b44,5 c145 d31	46	1 55x55x145h	0,43	4 100x120x160h	1,92	

Fix Ground
Fix Wall
pagina 272

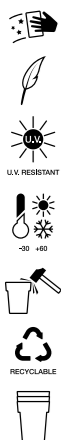

Pasubio quadro



Superficie opaca
Matt finished
Surface opaque
Matt-Oberfläche



Pasubio cassa



Superficie opaca
Matt finished
Surface opaque
Matt-Oberfläche



201

cappuccino/cappuccino
cappuccino/cappuccino

032

antracite/anthracite
anthracite/anthrazitgrau



201

cappuccino/cappuccino
cappuccino/cappuccino

032

antracite/anthracite
anthracite/anthrazitgrau

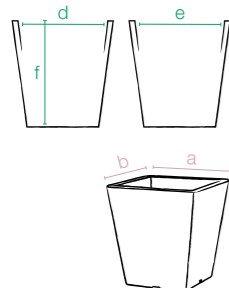

codice senza colore code without colour	Cm	dimensioni esterne external dimensions	dimensioni interne internal dimensions	litri liters	Confezione minima Minimum package	m ³	pezzi pallet pcs pallet	m ³
11 463 040	40	a40 b40 c42	d34 e34 f42	40	2 40x40x71h	0,11	24 80x120x210h	2,02

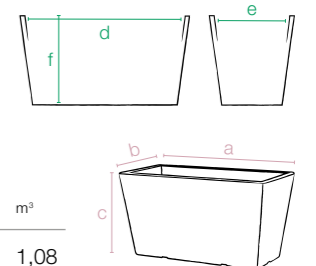

codice senza colore code without colour	Cm	dimensioni esterne external dimensions	dimensioni interne internal dimensions	litri liters	Confezione minima Minimum package	m ³	pezzi pallet pcs pallet	m ³
11 464 080	80	a80 b40 c42	d74 e34 f42	66	2 80x40x71h	0,22	12 80x120x112h	1,08



Pasubio alto



Superficie opaca
Matt finished
Surface opaque
Matt-Oberfläche



201

cappuccino/cappuccino
cappuccino/cappuccino



032

antracite/anthracite
anthracite/anthrazitgrau

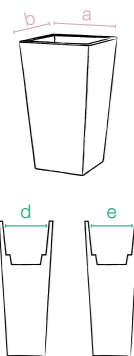

codice senza colore code without colour	Cm	dimensioni esterne external dimensions	dimensioni interne internal dimensions	litri liters	Confezione minima Minimum package	m ³	pezzi pallet pcs pallet	m ³	accessori accessories
11 462 070	70	a40 b40 c68	d34 e34 f25	31	1 40x40x70h	0,11	24 80x120x210h	2,02	
11 462 100	100	a40 b40 c100	d34 e34 f25	32	1 40x40x100h	0,16	12 80x120x212h	2,04	

Fix Ground
Fix Wall
pagina 272

Pasubio Alto,
Quadro e Cassa
componibili
modular
modulable
zusammensetzbar

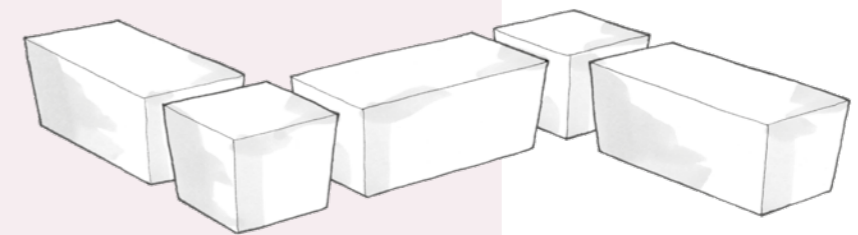

Pasubio Alto, Pasubio Quadro e Pasubio Cassa si prestano molto bene per organizzare gli spazi

Pasubio Quadro and Pasubio Cassa lend very well to organize spaces

Pasubio Quadro et Pasubio Cassa se prêtent très bien pour l'organisation des espaces

Pasubio Quadro und Pasubio Cassa sind ideal für die Organization der Räume

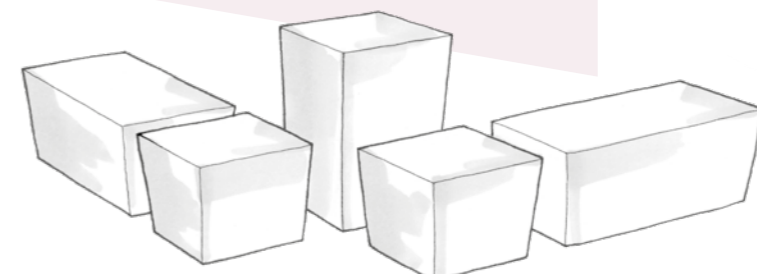
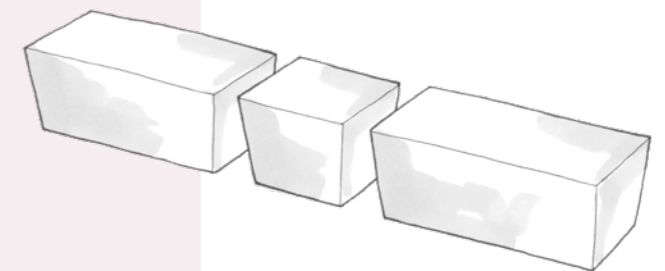
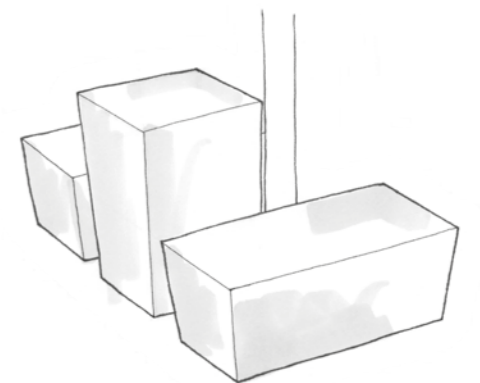

Schio ciotola



Superficie opaca
Matt finished
Surface opaque
Matt-Oberfläche



Valentino

Superficie opaca / Matt finished
Surface opaque / Matt-Oberfläche

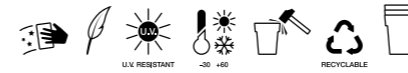

043
bianco/white
blanc/weiß



201
cappuccino/cappuccino
cappuccino/cappuccino



032
antracite/anthracite
anthracite/anthrazitgrau



050
rosso cardinale/cardinal red
rouge cardinal/scharlachrot

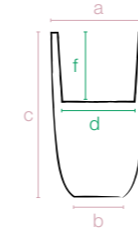

codice senza colore code without colour	Cm	dimensioni esterne external dimensions			dimensioni interne internal dimensions		litri liters	Confezione minima Minimum package	m ³	pezzi pallet pcs pallet	m ³	accessori accessories	
11 432 050	50	a34	b21	c50	d26	f22	10	2 34x68x50h	0,11	16	80x120x112h	1,08	
11 432 070	70	a42	b25	c70	d32	f28	17	1 42x42x70h	0,12	18	80x120x226h	2,17	
11 432 090	90	a52	b30	c90	d40	f28	29	1 52x52x90h	0,24	8	100x120x195h	2,34	

Fix Ground - Fix Wall
pagina 272

Bassano

Superficie opaca / Matt finished
Surface opaque / Matt-Oberfläche

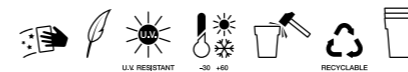

043
bianco/white
blanc/weiß



201
cappuccino/cappuccino
cappuccino/cappuccino



032
antracite/anthracite
anthracite/anthrazitgrau



050
rosso cardinale/cardinal red
rouge cardinal/scharlachrot

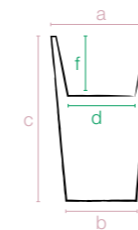

codice senza colore code without colour	Cm	dimensioni esterne external dimensions			dimensioni interne internal dimensions		litri liters	Confezione minima Minimum package	m ³	pezzi pallet pcs pallet	m ³	accessori accessories	
11 423 060	60	a36	b29	c60	d27	f20	10	1 45x45x60h	0,12	24	80x120x202h	1,94	
11 423 100	100	a48	b35	c100	d35	f34	20	1 60x60x100h	0,36	6	100x120x165h	1,58	

Fix Ground - Fix Wall
pagina 272



043
bianco/white
blanc/weiß



201
cappuccino/cappuccino
cappuccino/cappuccino



032
antracite/anthracite
anthracite/anthrazitgrau



050
rosso cardinale/cardinal red
rouge cardinal/scharlachrot



039
bronzo/bronze
bronze/bronze



030
anticato/light brown
marron clair/hellbraun

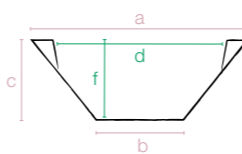

codice senza colore code without colour	Cm	dimensioni esterne external dimensions			dimensioni interne internal dimensions		litri liters	Confezione minima Minimum package	m ³	pezzi pallet pcs pallet	m ³	
11 433 060	60	a60	b24,5	c22	d48	e21	22	2 60x60x30h	0,10	26	80x120x113h	1,08
11 433 080	80	a80	b32,5	c29	d64,5	e28	54	2 80x80x39h	0,25	10	80x80x113h	0,72
11 433 100	100	a100	b40	c37	d80	e36	106	1 100x100x37h	0,37	7	100x120x113h	1,36

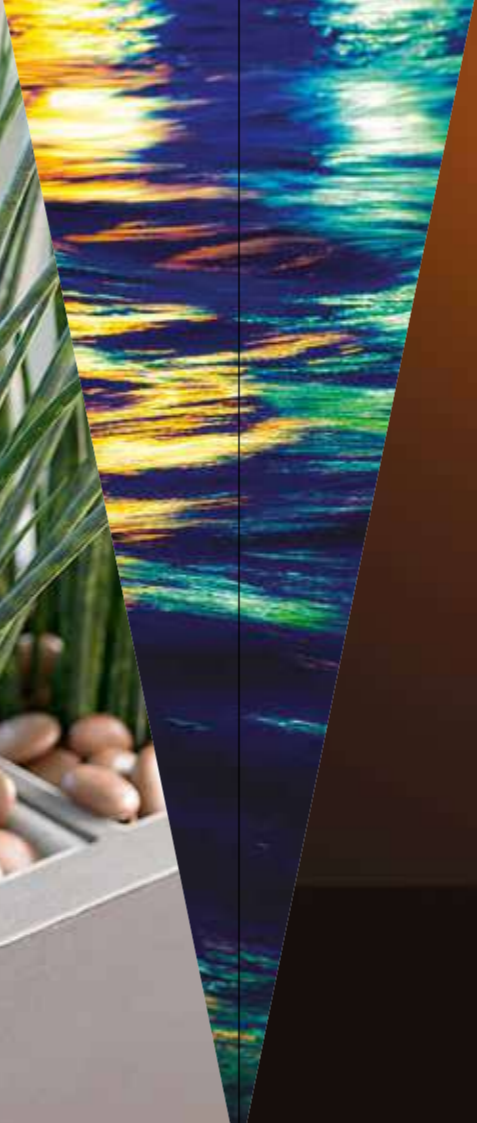

SELF WATERING



Divio



Schio Cubo



Schio Cassa

Essential Self Watering



Riserva d'acqua

La riserva d'acqua permette di alimentare le vostre piante senza bisogno di irrigarle spesso. I fori di drenaggio per il "troppo pieno" permettono di scaricare eventuali eccessi di acqua così sarà la pianta stessa ad attingere alla riserva d'acqua quando ne avrà bisogno.

Water reserve

The water reservoir allows to feed your plants without having to water it often. The drainage holes for the "overflow" allow you to download any excess water so the plant itself will be to draw on the reserve of water when it needs them. Some of the pots equipped with this system also have a coating membrane that, once removed, it allows excess water to leak from the pots.

Avec reserve de l'eau

Le réservoir d'eau permet de nourrir vos plantes sans avoir à les arroser souvent. Les trous de drainage pour le «débordement» vous permettent de télécharger tout excès d'eau de sorte que sera elle-même à puiser dans la réserve d'eau quand il en aura besoin. Certains des pots équipés de ce système ont également une membrane d'enrobage qui, une fois enlevé, permet à l'eau en excès de sortir.

Wasser reservoir

Das Wasser-Reservoir ermöglicht, Ihre Pflanzen zu versorgen, ohne ständig Wasser zuzuführen. Die Entwässerungslöcher lassen das Wasser überlaufen, damit die Pflanze das nach Bedarf schöpfen kann. Einige Pflanzgefäße mit Wasserspeicher besitzen eine Abdeckung-Membrane, die das Wasser, bei Wegnahme, überlaufen lässt.

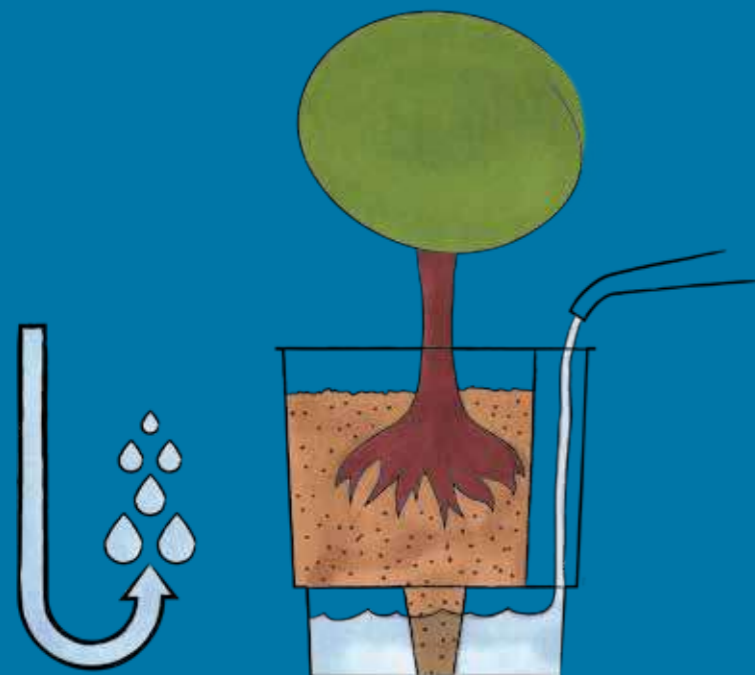

Evita l'annidamento di zanzare e altri insetti

It stops mosquitoes and other insects from laying eggs

Évite la nidation des moustiques et autres insectes

Das Einnisten von Mücken und anderen Insekten wird verhindert

Divio self watering



043
bianco/white
blanc/weiß



201
cappuccino/cappuccino
cappuccino/cappuccino



210
grafite/graphite
graphite/graphit



232
kiwi/kiwi
kiwi/Kiwi

colour on demand 030 050 211 202 068 203 208 230 233 234 204 049 204 039

codice senza colore code without colour	Cm	dimensioni esterne external dimensions	Confezione minima Minimum package	pezzi pallet pcs pallet
16 466 080	80	a90 b27 c77	1 91x28x79h	0,2 8 80x120x201h 1,93

diffusione dell'acqua per osmosi
water diffusion through osmosis's effect
diffusion de l'eau par osmose
Wasserdiffusion durch Osmose

riserva d'acqua
water reserve
réserve d'eau
Wasser-Reservoir

beccuccio per inserimento dell'acqua
spout for water insertion
bec pour l'introduction de l'eau
Füllschacht zur Wasserversorgung

griglia di drenaggio
drainage grid
gril pour le drainage
Bewässerungseinsatz



Schio cubo self watering



043 bianco/white
blanc/weiß

201 cappuccino/cappuccino
cappuccino/cappuccino

032 antracite/anthracite
anthracite/anthrazitgrau

050 rosso cardinale/cardinal red
rouge cardinal/scharlachrot

039 bronzo/bronze
bronze/bronze

codice senza colore code without colour	Cm	dimensioni esterne external dimensions	Confezione minima Minimum package	m ³	pezzi pallet pcs pallet	m ³
16 425 030	30	a:30 b:30 c:28	1 30x30x30h	0,02	24	80x120x115h 1,10

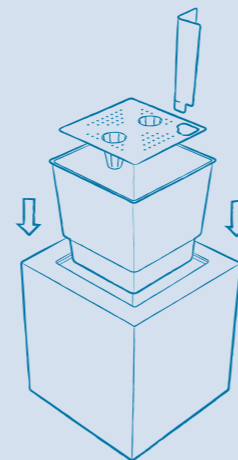
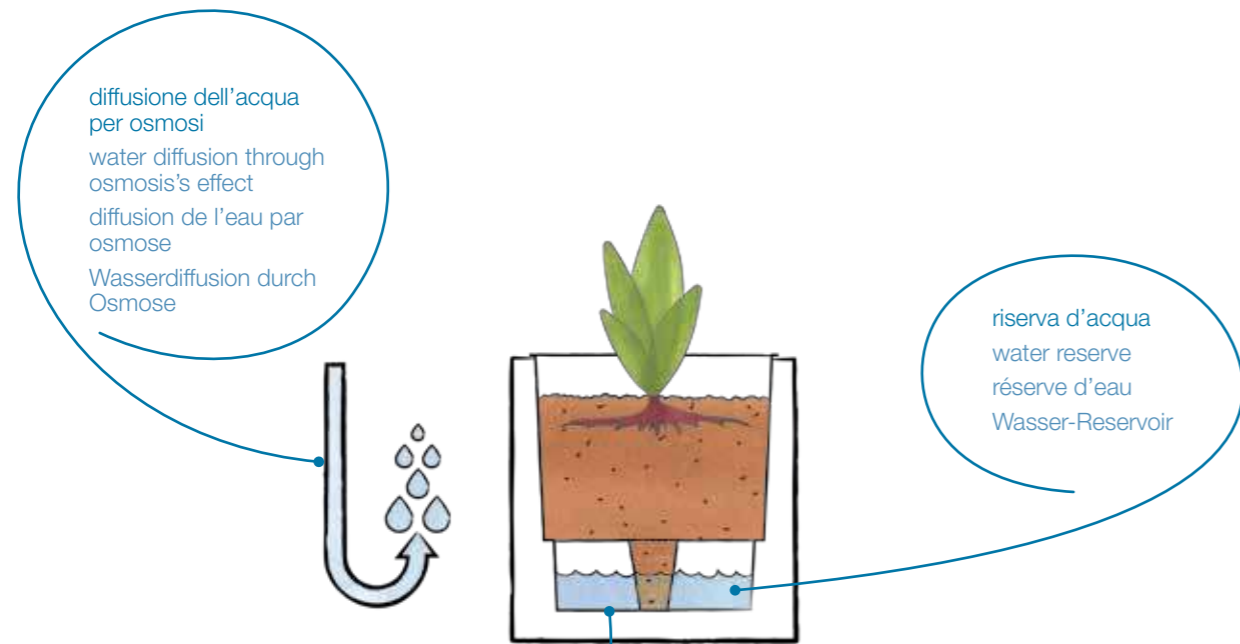

Schio cassa self watering



043 bianco/white
blanc/weiß

201 cappuccino/cappuccino
cappuccino/cappuccino

032 antracite/anthracite
anthracite/anthrazitgrau

050 rosso cardinale/cardinal red
rouge cardinal/scharlachrot

039 bronzo/bronze
bronze/bronze

codice senza colore code without colour	Cm	dimensioni esterne external dimensions	Confezione minima Minimum package	m ³	pezzi pallet pcs pallet	m ³
16 427 080	80	a:80 b:30 c:30	2 80x30x30h	0,07	28	80x120x222h 2,13

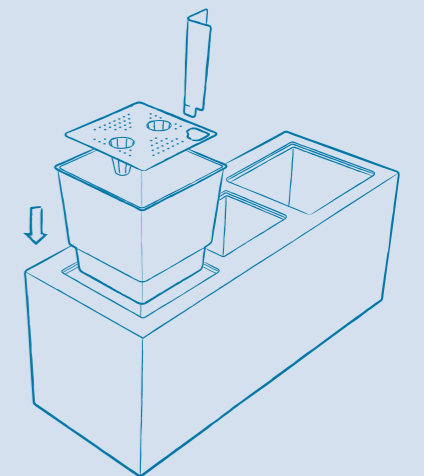
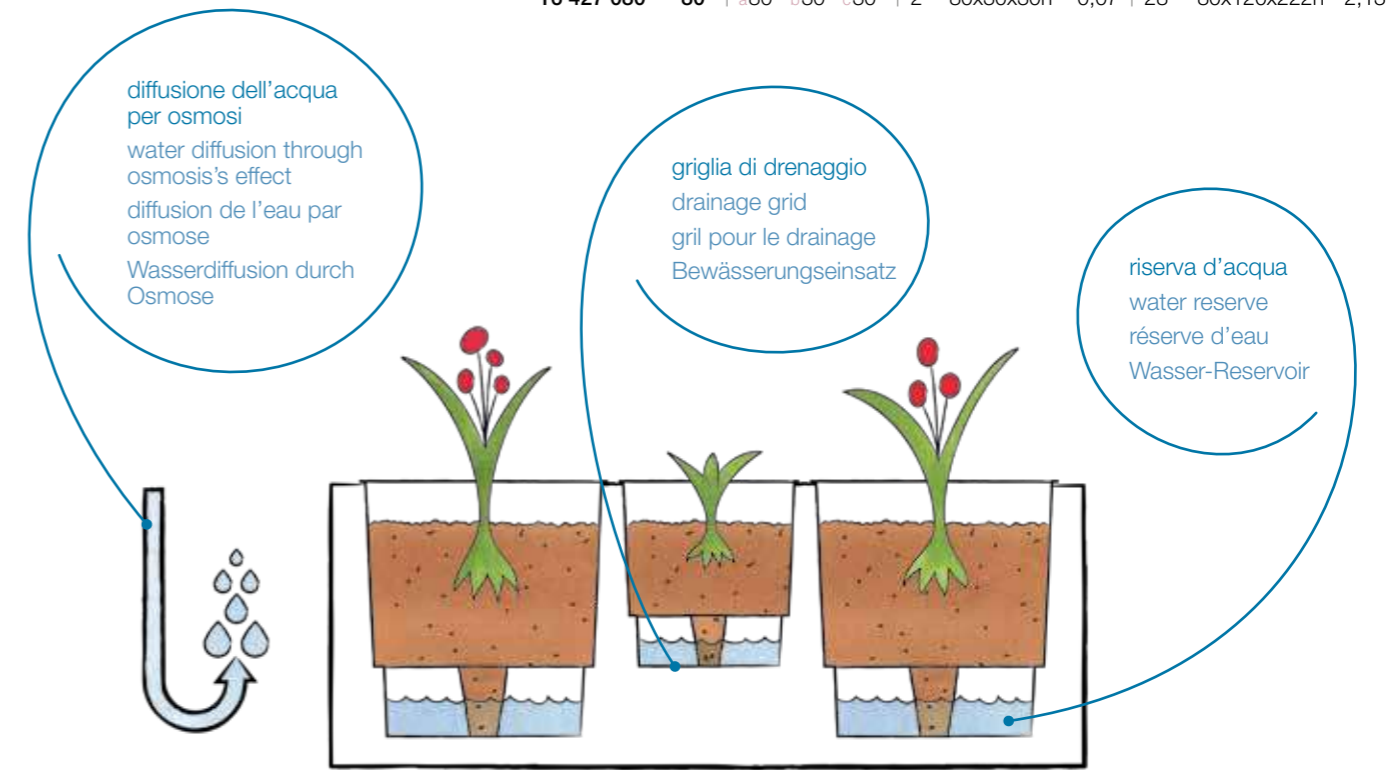



linea
CLASSIC



Flora



Cilindro Vicenza



Cassetta Liscia



Quadro Liscio



Africa



Tulipano



Vaso Festonato



Vaso Doppio Bordo



Campana Chiampo



Cassetta Leonardo

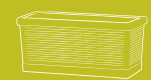

Cassetta Millerighe



Quadro Millerighe



Ciotola Castello



Conca Classica



Vaso Muro Righe



Vaso Muro Liscio



Sottovaso Muro



Sottovaso Tondo



Sottovaso Quadro



Sottocassetta



Superficie opaca
Matt finished
Surface opaque
Matt-Oberfläche



Superficie opaca
Matt finished
Surface opaque
Matt-Oberfläche



Flora

cilindro **Vicenza**



030

anticato/light brown
marron clair/hellbraun



201

cappuccino/cappuccino
cappuccino/cappuccino



032

antracite/anthracite
anthracite/anthrazitgrau



Sottovaso
pagina 248



030

anticato/light brown
marron clair/hellbraun



201

cappuccino/cappuccino
cappuccino/cappuccino



032

antracite/anthracite
anthracite/anthrazitgrau



Sottovaso
pagina 248

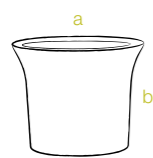

codice senza colore code without colour	Cm	dimensioni dimensions	litri liters		Confezione minima Minimum package	m³	pezzi pallet pcs pallet	m³
02 441 040	40	a40 b33	26	37	4 40x40x53h	0,08	72 80x120x115h	1,10
02 441 045	45	a45 b38	34	40	2 45x45x44h	0,08	125 100x120x224h	2,69
02 441 050	50	a50 b41	47	47	2 50x50x49h	0,12	64 100x120x220h	2,64

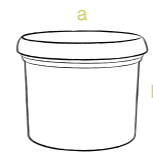

codice senza colore code without colour	Cm	dimensioni dimensions	litri liters		Confezione minima Minimum package	m³	pezzi pallet pcs pallet	m³
02 443 040	40	a40 b30	26	37	4 40x40x51h	0,08	66 80x120x115h	1,10
02 443 045	45	a45 b34	40	40	2 45x45x41h	0,08	75 80x120x220h	2,11
02 443 050	50	a50 b38	52	47	2 50x50x46h	0,11	66 100x120x225h	2,70
02 443 060	60	a60 b45	94	54	2 60x60x55h	0,19	34 80x120x214h	2,05
02 443 070	70	a70 b53	145	66	1 70x70x53h	0,26	15 80x80x224h	1,43



Superficie opaca
Matt finished
Surface opaque
Matt-Oberfläche



cassetta **Liscia**



Superficie opaca
Matt finished
Surface opaque
Matt-Oberfläche



quadro **Liscio**



030

anticato/light brown
marron clair/hellbraun



201

cappuccino/cappuccino
cappuccino/cappuccino



032

antracite/anthracite
anthracite/anthrazitgrau



Sottocassetta
pagina 249



030

anticato/light brown
marron clair/hellbraun



201

cappuccino/cappuccino
cappuccino/cappuccino



032

antracite/anthracite
anthracite/anthrazitgrau



Sottovaso
pagina 248

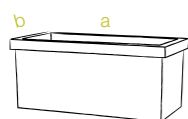

codice senza colore code without colour	Cm	dimensioni dimensions			litri liters	Confezione minima Minimum package	m ³	pezzi pallet pcs pallet	m ³	
02 444 080	80	a 80	b 40	c 35	78	80	2 80x40x70h	0,22	18 80x120x224h	2,15
02 444 100	100	a 100	b 46	c 41	133	100	2 100x46x82h	0,37	10 100x120x220h	2,64

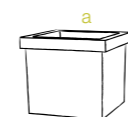

codice senza colore code without colour	Cm	dimensioni dimensions			litri liters	Confezione minima Minimum package	m ³	pezzi pallet pcs pallet	m ³	
02 445 040	40	a 40	b 40	c 35	35	46	2 40x40x70h	0,11	18 80x120x117h	1,12
02 445 046	46	a 46	b 46	c 41	56	46	2 46x46x82h	0,17	20 100x120x219h	2,63
02 445 055	55	a 55	b 55	c 48	95	56	2 55x55x48h	0,29	16 120x120x207h	2,98



Africa

Superficie opaca / Matt finished
Surface opaque / Matt-Oberfläche



030

anticato/light brown
marron clair/hellbraun



201

cappuccino/cappuccino
cappuccino/cappuccino



032

antracite/anthracite
anthracite/anthrazitgrau

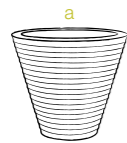

codice senza colore code without colour	Cm	dimensioni dimensions	litri liters	Confezione minima Minimum package	m ³	pezzi pallet pcs pallet	m ³
02 418 080	80	a 80 b 69	82	1 80x80x70h	0,44	5 80x80x213h	1,36
02 418 105	105	a 105 b 90	161	1 105x105x90h	0,99	4 100x120x238h	2,86

vaso Festonato

Superficie opaca / Matt finished
Surface opaque / Matt-Oberfläche



030

anticato/light brown
marron clair/hellbraun



201

cappuccino/cappuccino
cappuccino/cappuccino



032

antracite/anthracite
anthracite/anthrazitgrau



Sottovaso
pagina 248



codice senza colore code without colour	Cm	dimensioni dimensions	litri liters	Confezione minima Minimum package	m ³	pezzi pallet pcs pallet	m ³
02 400 030	30	a 30 b 16 c 25	8	22 4 30x30x46h	0,04	96 80x120x113h	1,08
02 400 035	35	a 35 b 20 c 29,5	15	27 4 35x35x52h	0,06	66 80x120x112h	1,08
02 400 040	40	a 40 b 22 c 35	22	30 4 40x40x61h	0,09	54 80x120x112h	1,08
02 400 045	45	a 45 b 40 c 39	34	33 2 45x45x48h	0,09	88 80x120x220h	2,11
02 400 050	50	a 50 b 28 c 43	46	37 2 50x50x52h	0,13	80 100x120x222h	2,66
02 400 055	55	a 55 b 32 c 48	67	40 2 55x55x59h	0,17	40 80x120x224h	2,15
02 400 060	60	a 60 b 35 c 50	84	47 2 60x60x62h	0,22	30 80x120x226h	2,07
02 400 070	70	a 70 b 40 c 58	123	47 1 70x70x59h	0,28	14 80x80x224h	1,43
02 400 080	80	a 80 b 43 c 63	245	50 1 80x80x63h	0,40	13 80x80x217h	1,39

Tulipano

Superficie opaca / Matt finished
Surface opaque / Matt-Oberfläche



030

anticato/light brown
marron clair/hellbraun



201

cappuccino/cappuccino
cappuccino/cappuccino



032

antracite/anthracite
anthracite/anthrazitgrau



codice senza colore code without colour	Cm	dimensioni dimensions	litri liters	Confezione minima Minimum package	m ³	pezzi pallet pcs pallet	m ³	accessori accessories
02 419 110	110	a 62,5 b 110	65	1 65x65x110h	0,46	6 100x120x230h	2,76	

Fix Ground
Fix Wall
pagina 272

vaso doppio bordo

Superficie opaca / Matt finished
Surface opaque / Matt-Oberfläche



030

anticato/light brown
marron clair/hellbraun



201

cappuccino/cappuccino
cappuccino/cappuccino



032

antracite/anthracite
anthracite/anthrazitgrau



Sottovaso
pagina 248

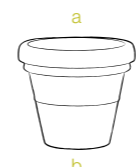

codice senza colore code without colour	Cm	dimensioni dimensions	litri liters	Confezione minima Minimum package	m ³	pezzi pallet pcs pallet	m ³
02 401 030	30	a 30 b 16,5 c 25	8	22 4 30x30x46h	0,04	96 80x120x115h	1,10
02 401 035	35	a 35 b 20 c 29	15	27 4 35x35x52h	0,06	60 80x120x113h	1,08
02 401 040	40	a 40 b 22 c 35	22	30 4 40x40x61h	0,09	48 80x120x112h	1,08
02 401 045	45	a 45 b 26 c 39	34	33 2 45x45x48h	0,09	80 80x120x220h	2,11
02 401 050	50	a 50 b 29 c 43	45	37 2 50x50x52h	0,13	76 100x120x228h	2,74
02 401 055	55	a 55 b 33 c 48	67	40 2 55x55x59h	0,17	36 80x120x220h	2,11
02 401 060	60	a 60 b 35 c 53	85	47 2 60x60x62h	0,22	30 80x120x219h	2,10
02 401 070	70	a 70 b 40 c 58	125	47 1 70x70x59h	0,28	14 80x80x219h	1,40
02 401 085	85	a 85 b 52,5 c 70	232	60 1 85x85x70h	0,50	11 100x120x215h	1,58

campana Chiampo

Superficie opaca / Matt finished
Surface opaque / Matt-Oberfläche



030
anticato/light brown
marron clair/hellbraun



201
cappuccino/cappuccino
cappuccino/cappuccino



032
antracite/anthracite
anthracite/anthrazitgrau



Sottovaso
pagina 248

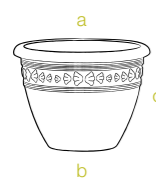

codice senza colore code without colour	Cm	dimensioni dimensions			litri liters		Confezione minima Minimum package	m ³	pezzi pallet pcs pallet		m ³
02 403 030	30	a30	b25,5	c23	8	22	4 30x30x51h	0,04	72	80x120x115h	1,10
02 403 040	40	a40	b33	c30	18	27	4 40x40x66h	0,10	42	80x120x115h	1,10
02 403 060	60	a60	b50	c47	65	40	4 60x60x67h	0,24	22	80x120x223h	2,23

cassetta Millerighe

Superficie opaca / Matt finished
Surface opaque / Matt-Oberfläche



030
anticato/light brown
marron clair/hellbraun



201
cappuccino/cappuccino
cappuccino/cappuccino



032
antracite/anthracite
anthracite/anthrazitgrau



Sottocassetta
pagina 249

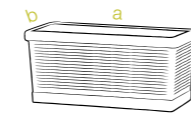

codice senza colore code without colour	Cm	dimensioni dimensions			litri liters		Confezione minima Minimum package	m ³	pezzi pallet pcs pallet		m ³
02 408 060	60	a59	b27	c27,6	32	60	2 59x27x56h	0,08	48	80x120x229h	2,20
02 408 080	80	a79	b34	c34	70	80	2 79x34x68h	0,18	18	80x120x221h	2,12
02 408 094	94	a94	b40	c38	130	100	2 94x40x76h	0,28	10	100x120x202h	2,42
02 408 100	100	a100	b44	c40	146	100	2 100x44x80h	0,35	10	100x120x228h	2,74

cassetta Leonardo

Superficie opaca / Matt finished
Surface opaque / Matt-Oberfläche



030
anticato/light brown
marron clair/hellbraun



201
cappuccino/cappuccino
cappuccino/cappuccino



032
antracite/anthracite
anthracite/anthrazitgrau



Sottocassetta
pagina 249

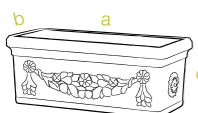

codice senza colore code without colour	Cm	dimensioni dimensions			litri liters		Confezione minima Minimum package	m ³	pezzi pallet pcs pallet		m ³
02 406 060	60	a58	b29	c27	29	60	2 58x29x54h	0,09	48	80x120x220h	2,11
02 406 080	80	a80	b34	c32	57	80	2 80x34x64h	0,17	18	80x120x202h	1,94
02 406 100	100	a100	b45	c40	120	100	2 100x45x80h	0,36	10	100x120x212h	2,54

quadro Millerighe

Superficie opaca / Matt finished
Surface opaque / Matt-Oberfläche



030
anticato/light brown
marron clair/hellbraun



201
cappuccino/cappuccino
cappuccino/cappuccino



032
antracite/anthracite
anthracite/anthrazitgrau



Sottovaso
pagina 249

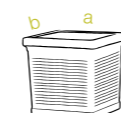

codice senza colore code without colour	Cm	dimensioni dimensions			litri liters		Confezione minima Minimum package	m ³	pezzi pallet pcs pallet		m ³
02 409 035	35	a35	b35	c34,6	28	36	2 35x35x70h	0,08	36	80x120x218h	2,09
02 409 040	40	a40	b40	c39,6	41	46	2 40x40x80h	0,12	30	80x120x207h	1,99
02 409 045	45	a45	b45	c40,1	59	46	2 45x45x81h	0,16	20	100x120x235h	2,82

ciotola **Castello**

Superficie opaca / Matt finished
Surface opaque / Matt-Oberfläche



030

anticato/light brown
marron clair/hellbraun



201

cappuccino/cappuccino
cappuccino/cappuccino



032

antracite/anthracite
anthracite/anthrazitgrau



codice senza colore code without colour	Cm	dimensioni dimensions	litri liters	Confezione minima Minimum package	m ³	pezzi pallet pcs pallet	m ³
02 405 050	50	a50 b22	24	2 50x50x33h	0,08	32 80x120x115h	1,10
02 405 060	60	a60 b24,5	42	2 60x60x40h	0,14	12 80x120x115h	1,10
02 405 080	80	a80 b35	97	1 80x80x35h	0,22	11 80x80x210h	1,34

vaso **Muro righe**

Superficie opaca / Matt finished
Surface opaque / Matt-Oberfläche



030

anticato/light brown
marron clair/hellbraun



201

cappuccino/cappuccino
cappuccino/cappuccino



032

antracite/anthracite
anthracite/anthrazitgrau

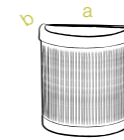

codice senza colore code without colour	Cm	dimensioni dimensions	Confezione minima Minimum package	m ³	pezzi pallet pcs pallet	m ³
02 413 048	48	a48 b32 c52	53	1 48x32x52h	0,08	14 100x120x118h 1,42

conca **Classica**

Superficie opaca / Matt finished
Surface opaque / Matt-Oberfläche



030

anticato/light brown
marron clair/hellbraun



201

cappuccino/cappuccino
cappuccino/cappuccino



032

antracite/anthracite
anthracite/anthrazitgrau



codice senza colore code without colour	Cm	dimensioni dimensions	litri liters	Confezione minima Minimum package	m ³	pezzi pallet pcs pallet	m ³
02 412 120	120	a120 b94	541	1 120x120x95h	1,36	6 120x120x197h	2,84

vaso **Muro liscio**

Superficie opaca / Matt finished
Surface opaque / Matt-Oberfläche



030

anticato/light brown
marron clair/hellbraun



201

cappuccino/cappuccino
cappuccino/cappuccino



032

antracite/anthracite
anthracite/anthrazitgrau



codice senza colore code without colour	Cm	dimensioni dimensions	Confezione minima Minimum package	m ³	pezzi pallet pcs pallet	m ³
02 414 050	48	a48 b32 c52	53	1 48x32x52h	0,08	14 100x120x118h 1,42

sottovaso Muro

Superficie opaca / Matt finished
Surface opaque / Matt-Oberfläche



030

anticato/light brown
marron clair/hellbraun



201

cappuccino/cappuccino
cappuccino/cappuccino



032

antracite/anthracite
anthracite/anthrazitgrau

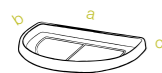

codice senza colore code without colour	Cm	dimensioni dimensions	Confezione minima Minimum package	m ³	pezzi pallet pcs pallet	m ³
02 429 053	53	a53 b38 c4,5	1 53x38x5h	0,01	135 80x120x115h	1,10

sottovaso Quadro

Superficie opaca / Matt finished
Surface opaque / Matt-Oberfläche



043

bianco/white
blanc/weiß



030

anticato/light brown
marron clair/hellbraun



201

cappuccino/cappuccino
cappuccino/cappuccino



032

antracite/anthracite
anthracite/anthrazitgrau

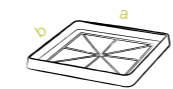

codice senza colore code without colour	Cm	dimensioni dimensions	Confezione minima Minimum package	m ³	pezzi pallet pcs pallet	m ³
02 417 030	30	a30 b30 c5	2 30x30x7h	0,01	270 80x120x115h	1,10
02 417 036	36	a41 b41 c5	2 41x41x7h	0,01	270 80x120x115h	1,10
02 417 046	46	a46 b46 c5	2 46x46x7h	0,01	80 80x120x115h	1,10
02 417 056	56	a56 b56 c5	2 56x56x7h	0,02	80 80x120x115h	1,10

sottovaso Tondo

Superficie opaca / Matt finished
Surface opaque / Matt-Oberfläche



043

bianco/white
blanc/weiß



030

anticato/light brown
marron clair/hellbraun



201

cappuccino/cappuccino
cappuccino/cappuccino



032

antracite/anthracite
anthracite/anthrazitgrau

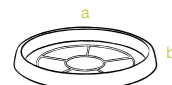

codice senza colore code without colour	Cm	dimensioni dimensions	Confezione minima Minimum package	m ³	pezzi pallet pcs pallet	m ³
02 415 022	22	a22 b4	10 22x22x18h	0,01	600 80x120x115h	1,10
02 415 027	27	a27 b4	10 27x27x22h	0,01	550 80x120x115h	1,10
02 415 030	30	a30 b4	8 30x30x15h	0,01	320 80x120x115h	1,10
02 415 033	33	a33 b4	8 33x33x15h	0,02	336 80x120x115h	1,10
02 415 037	37	a37 b4	8 37x37x15h	0,02	288 80x120x115h	1,10
02 415 040	40	a40 b5	8 40x40x15h	0,03	288 80x120x115h	1,10
02 415 047	47	a47 b5	6 47x47x14h	0,03	180 80x120x115h	1,10
02 415 050	50	a50 b5	6 50x50x14h	0,03	180 80x120x115h	1,10
02 415 054	54	a54 b5	4 54x54x11h	0,03	120 80x120x115h	1,10
02 415 060	60	a60 b5	4 60x60x11h	0,04	92 80x120x115h	1,10
02 415 066	66	a66 b6	2 66x66x13h	0,05	46 80x120x115h	1,10

Sottocassetta

Superficie opaca / Matt finished
Surface opaque / Matt-Oberfläche



043

bianco/white
blanc/weiß



030

anticato/light brown
marron clair/hellbraun



201

cappuccino/cappuccino
cappuccino/cappuccino



032

antracite/anthracite
anthracite/anthrazitgrau



codice senza colore code without colour	Cm	dimensioni dimensions	Confezione minima Minimum package	m ³	pezzi pallet pcs pallet	m ³
02 416 060	60	a60 b30 c5	2 60x31x7h	0,01	120 80x120x115h	1,10
02 416 080	80	a80 b36 c5	2 80x36x7h	0,02	80 80x120x115h	1,10
02 416 100	100	a100 b45 c5	2 100x45x7h	0,03	38 80x120x114h	1,10



linea
CITY



New York



Venezia



Roma

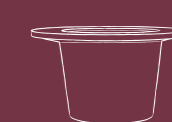

A-Malo



Superficie opaca
Matt finished
Surface opaque
Matt-Oberfläche



New York

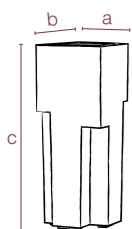

codice senza colore code without colour	Cm	dimensioni esterne external dimensions	Confezione minima Minimum package	m ³	pezzi pallet pcs pallet	m ³	accessori accessories
20 454 100	043 037 100	a39 b39 c100	1 40x40x102h	0,16	12 80x120x215h	2,06	

Fix Wall
pagina 273



Superficie opaca
Matt finished
Surface opaque
Matt-Oberfläche



Venezia

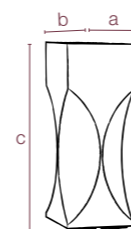
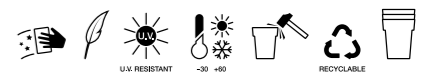

codice senza colore code without colour	Cm	dimensioni esterne external dimensions	Confezione minima Minimum package	m ³	pezzi pallet pcs pallet	m ³	accessori accessories
20 459 100	043 037 100	a39 b39 c100	1 40x40x102h	0,16	12 80x120x215h	2,06	

Fix Wall
pagina 273



Superficie opaca
Matt finished
Surface opaque
Matt-Oberfläche



Roma

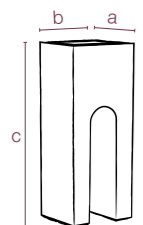
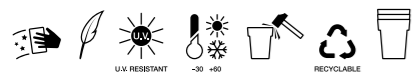

codice senza colore code without colour	Cm	dimensioni esterne external dimensions	Confezione minima Minimum package	m ³	pezzi pallet pcs pallet	m ³	accessori accessories
20 455 100	043 037 100	a39 b39 c100	1 40x40x102h	0,16	12 80x120x215h	2,06	

Fix Wall
pagina 273



Superficie opaca
Matt finished
Surface opaque
Matt-Oberfläche



A-malo

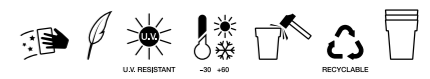

Sistema di aggancio
Coupling system
Système d'accrochage
Aufhäng System



Articolo composto da due pezzi per agevolare il trasporto
The item is made up of two components to facilitate the transport
Article composé de 2 pièces pour faciliter le transport
Artikel besteht aus zwei teilen um der Transport zu erleichtern

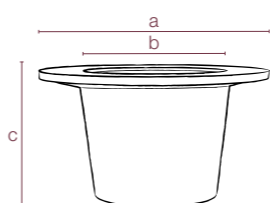

codice senza colore code without colour	Cm	dimensioni dimensions	Confezione minima Minimum package
20 458 150 vaso	043 037 150	b108 c110	1
20 452 150 anello	043 037 150	a150 c8	1
20 458 220 vaso	043 037 220	b158 c120	1
20 452 220 anello	043 037 220	a220 c10	1



linea
LUCE



Standard One
Outdoor



Spritz



Africa Outdoor



Tulipano Outdoor



Valentino
Outdoor



Pasubio Alto
Outdoor



Bassano
Outdoor



Schio Cassa Alta
Outdoor



Schio Cubo Alto
Outdoor



Schio Cono
Outdoor



Superficie opaca
Matt finished
Surface opaque
Matt-Oberfläche

Superficie opaca
Matt finished
Surface opaque
Matt-Oberfläche

Standard one outdoor

Spritz

caratteristiche lampada: attacco E27, tensione max 220, potenza max 11 W, tipo risp. energ. standard
lamp characteristics: electrical coupling E27, max voltage 220, max electrical power 11 W, standard energy saving type lamp
caractéristiques de l'ampoule: culot E27, tension max 220, puissance max 11W, type économie d'énergie standard
charakteristik der Lampe E27 Fassung, max. 220 Volt max. 11 W. Energiesparlampe Typ Standard

caratteristiche lampada: attacco E27, tensione max 220, potenza max 11 W, tipo risp. energ. standard
lamp characteristics: electrical coupling E27, max voltage 220, max electrical power 11 W, standard energy saving type lamp
caractéristiques de l'ampoule: culot E27, tension max 220, puissance max 11W, type économie d'énergie standard
charakteristik der Lampe E27 Fassung, max. 220 Volt max. 11 W. Energiesparlampe Typ Standard

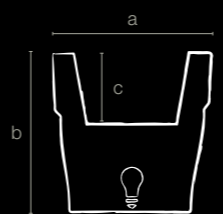
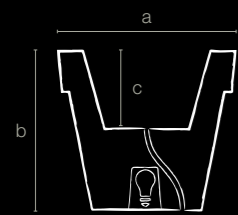

Fix Wall
pagina 273

Fix Wall
pagina 273

codice senza colore code without colour	Cm	dimensioni dimensions			litri liters	Confezione minima Minimum package	m ³	pezzi pallet pcs pallet	m ³	accessori accessories
13 437 070	033 70	a70	b63	c17	43	1 70x70x63h	0,30	4 80x80x220h	1,40	
13 437 080	033 80	a80	b72	c19	67	1 80x80x72h	0,40	4 80x80x220h	1,40	
13 437 100	033 100	a100	b90	c24	123	1 100x100x90h	0,90	3 100x120x220h	2,60	
13 437 120	033 120	a120	b108	c30	191	1 120x120x108h	1,50	2 120x120x220h	3,10	

codice senza colore code without colour	Cm	dimensioni dimensions			litri liters	Confezione minima Minimum package	m ³	pezzi pallet pcs pallet	m ³	accessori accessories
05 446 038	033 38	a38	b35	c16,5	43	1 40x40x63h	0,06	18 80x120x130h	1,20	



Superficie opaca
Matt finished
Surface opaque
Matt-Oberfläche



Africa outdoor



Superficie opaca
Matt finished
Surface opaque
Matt-Oberfläche



Tulipano outdoor

caratteristiche lampada: attacco E27, tensione max 220, potenza max 11 W, tipo risp. energ. standard

lamp characteristics: electrical coupling E27, max voltage 220, max electrical power 11 W, standard energy saving type lamp

caractéristiques de l'ampoule: culot E27, tension max 220, puissance max 11W, type économie d'énergie standard

charakteristik der Lampe E27 Fassung, max. 220 Volt max. 11 W. Energiesparlampe Typ Standard

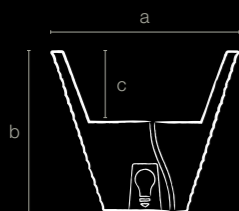

codice senza colore code without colour	Cm	dimensioni dimensions	litri liters	Confezione minima Minimum package	m ³	pezzi pallet pcs pallet	m ³
13 418 080 ⁰³³	80	a 80 b 69 c 36	82	1 80x80x70h	0,40	5 80x80x216h	1,40
13 418 105 ⁰³³	105	a 105 b 90 c 42	161	1 105x105x90h	0,99	2 105x120x144h	1,81

caratteristiche lampada: attacco E27, tensione max 220, potenza max 11 W, tipo risp. energ. standard

lamp characteristics: electrical coupling E27, max voltage 220, max electrical power 11 W, standard energy saving type lamp

caractéristiques de l'ampoule: culot E27, tension max 220, puissance max 11W, type économie d'énergie standard

charakteristik der Lampe E27 Fassung, max. 220 Volt max. 11 W. Energiesparlampe Typ Standard

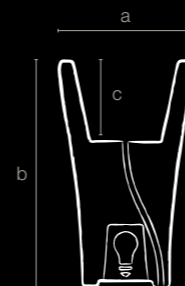

codice senza colore code without colour	Cm	dimensioni dimensions	litri liters	Confezione minima Minimum package	m ³	pezzi pallet pcs pallet	m ³	accessori accessories
13 419 110 ⁰³³	110	a 65 b 110 c 39	65	1 65x65x110h	0,50	6 100x120x230h	0,76	

Fix Wall
pagina 273





Valentino outdoor

Superficie opaca
Matt finished
Surface opaque
Matt-Oberfläche

Superficie opaca
Matt finished
Surface opaque
Matt-Oberfläche

Pasubio alto outdoor

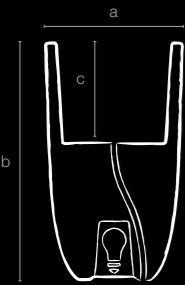

codice senza colore code without colour	Cm	dimensioni dimensions			litri liters	Confezione minima Minimum package	m ³	pezzi pallet pcs pallet	m ³	accessori accessories
13 432 050 033	50	a34	b50	c22	10	1 34x34x50h	0,06	16 80x120x112h	1,10	
13 432 070 033	70	a42	b70	c28	17	1 42x42x70h	0,10	18 80x120x226h	2,20	
13 432 090 033	90	a52	b90	c30	29	1 52x52x90h	0,20	8 100x120x195h	2,30	

caratteristiche lampada: attacco E27, tensione max 220, potenza max 11 W, tipo risp. energ. standard
 lamp characteristics: electrical coupling E27, max voltage 220, max electrical power 11 W, standard energy saving type lamp
 caractéristiques de l'ampoule: culot E27, tension max 220, puissance max 11W, type économie d'énergie standard
 charakteristik der Lampe E27 Fassung, max. 220 Volt max. 11 W. Energiesparlampe Typ Standard

Fix Ground
Fix Wall
pagina 272

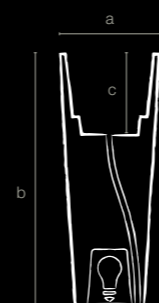

codice senza colore code without colour	Cm	dimensioni dimensions			litri liters	Confezione minima Minimum package	m ³	pezzi pallet pcs pallet	m ³	accessori accessories
13 462 070 033	70	a40	b68	c25	31	1 40x40x70h	0,10	24 80x120x210h	2,00	
13 462 100 033	100	a40	b100	c39	32	1 40x40x100h	0,10	12 80x120x212h	2,00	

caratteristiche lampada: attacco E27, tensione max 220, potenza max 11 W, tipo risp. energ. standard
 lamp characteristics: electrical coupling E27, max voltage 220, max electrical power 11 W, standard energy saving type lamp
 caractéristiques de l'ampoule: culot E27, tension max 220, puissance max 11W, type économie d'énergie standard
 charakteristik der Lampe E27 Fassung, max. 220 Volt max. 11 W. Energiesparlampe Typ Standard

Fix Ground
Fix Wall
pagina 272





Superficie opaca
Matt finished
Surface opaque
Matt-Oberfläche

Superficie opaca
Matt finished
Surface opaque
Matt-Oberfläche

Bassano outdoor

Schio cassa alta outdoor

caratteristiche lampada: attacco E27, tensione max 220, potenza max 11 W, tipo risp. energ. standard
lamp characteristics: electrical coupling E27, max voltage 220, max electrical power 11 W, standard energy saving type lamp
caractéristiques de l'ampoule: culot E27, tension max 220, puissance max 11W, type économie d'énergie standard
charakteristik der Lampe E27 Fassung, max. 220 Volt max. 11 W. Energiesparlampe Typ Standard

caratteristiche lampada: attacco E27, tensione max 220, potenza max 11 W, tipo risp. energ. standard
lamp characteristics: electrical coupling E27, max voltage 220, max electrical power 11 W, standard energy saving type lamp
caractéristiques de l'ampoule: culot E27, tension max 220, puissance max 11W, type économie d'énergie standard
charakteristik der Lampe E27 Fassung, max. 220 Volt max. 11 W. Energiesparlampe Typ Standard

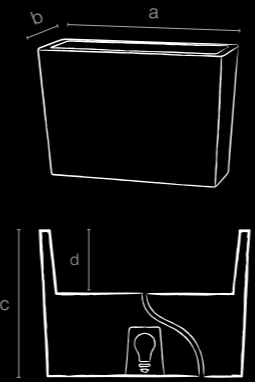
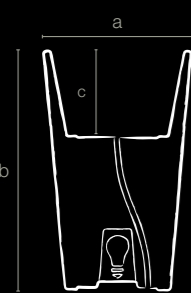

codice senza colore code without colour	Cm	dimensioni dimensions	litri liters	Confezione minima Minimum package	m ³	pezzi pallet pcs pallet	m ³	accessori accessories
13 423 060 033	60	a45 b60 c20	17	1 45x45x60h	0,10	12 80x120x200h	2,40	
13 423 100 033	100	a60 b100 c39	48	1 60x60x100h	0,30	4 80x120x220h	2,10	

Fix Ground
Fix Wall
pagina 272

codice senza colore code without colour	Cm	dimensioni dimensions	litri liters	Confezione minima Minimum package	m ³	pezzi pallet pcs pallet	m ³
13 428 050 033	50	a50 b36 c70 d29	31	1 50x36x70h	0,10	12 80x120x222h	2,10
13 428 100 033	100	a100 b36 c70 d29	70	1 100x36x70h	0,20	6 80x120x222h	2,10



Superficie opaca
Matt finished
Surface opaque
Matt-Oberfläche

Superficie opaca
Matt finished
Surface opaque
Matt-Oberfläche

Schio cubo alto outdoor

Schio cono outdoor

caratteristiche lampada: attacco E27, tensione max 220, potenza max 11 W, tipo risp. energ. standard

lamp characteristics: electrical coupling E27, max voltage 220, max electrical power 11 W, standard energy saving type lamp

caractéristiques de l'ampoule: culot E27, tension max 220, puissance max 11W, type économie d'énergie standard

charakteristik der Lampe E27 Fassung, max. 220 Volt max. 11 W. Energiesparlampe Typ Standard

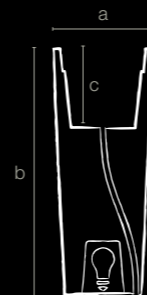

caratteristiche lampada: attacco E27, tensione max 220, potenza max 11 W, tipo risp. energ. standard

lamp characteristics: electrical coupling E27, max voltage 220, max electrical power 11 W, standard energy saving type lamp

caractéristiques de l'ampoule: culot E27, tension max 220, puissance max 11W, type économie d'énergie standard

charakteristik der Lampe E27 Fassung, max. 220 Volt max. 11 W. Energiesparlampe Typ Standard

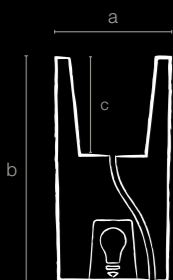
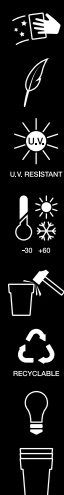

codice senza colore code without colour	Cm	dimensioni dimensions	litri liters	Confezione minima Minimum package	m ³	pezzi pallet pcs pallet	m ³	accessori accessories	
13 426 080	033	80	a40 b80 c34,5	31	1	40x40x80h	0,10	15 80x120x212h	2,00

Fix Wall
pagina 273

codice senza colore code without colour	Cm	dimensioni dimensions	litri liters	Confezione minima Minimum package	m ³	pezzi pallet pcs pallet	m ³	accessori accessories	
13 424 070	033	70	a30 b68 c20	8	1	30x30x68h	0,06	24 80x120x225h	2,10
13 424 090	033	90	a40 b90 c35	26	1	40x40x90h	0,10	12 80x120x195h	1,80
13 424 110	033	110	a45 b110 c35	35	1	45x45x110h	0,20	12 80x120x236h	2,20
13 424 145	033	145	a55 b145 c31	46	1	55x55x145h	0,40	4 100x120x160h	1,90

Fix Ground
Fix Wall
pagina 272





Per installazione all'esterno. Certificati CE, classe di isolamento IP55, completi di cavo di alimentazione, presa bipolare, lampada. Non sono dotati di interruttore. Si consiglia che l'installazione all'esterno venga effettuata da personale qualificato. Le versioni outdoor sono dotate di un foro e un tubo per il drenaggio dell'acqua che si potrà accumulare nel contenitore. È fondamentale che il foro e il tubo non vengano ostruiti in modo tale da permettere un sicuro drenaggio. Per questo consigliamo di non mettere mai la pianta o la terra direttamente nel contenitore ma di posizionare sempre un sottovaso e un vaso di contenimento di dimensioni appropriate. Pulire frequentemente il foro e il tubo di drenaggio.

so as to allow safe drainage. Therefore we recommend to never put the plant or the soil directly in the container but always place a saucer and a pot of appropriate sizes. Never put the soil or plant directly into the container. In this way you risk to obstruct the hole and the drainage tube compromising their operation and safety. Please clean frequently the hole and the drainage tube.

fonctionnement et la sûreté. Mettre toujours un sous-vase ou un vase de la dimension appropriées à la plante. Nettoyer souvent le trou et le tube de drainage.

For outdoor installation. Certificates CE, IP55 dielectric strength class, complete with power cord, hole plug, lamp. Not equipped with a switch. It is recommended that the installation is made by qualified personnel. The outdoor version is equipped with a hole and a tube to drain water that might be accumulated in the container. It is important that the hole and the tube will not be obstructed

Ne jamais mettre la terre ou la plante directement dans le recipient. De cette manière il peut s'obstruer l'orifice et le tuyau de drainage en compromettant le fonctionnement et la sûreté. Mettre toujours un sous-vase ou un vase de la dimension appropriées à la plante. Nettoyer souvent le trou et le tube de drainage.

Niemals Erde oder Pflanzen direkt in den Behälter setzen. Sie riskieren, dass Öffnung und Rohr der Drainage verstopfen und somit die Funktion und Sicherheit nicht gewährleistet ist. Benutzen Sie stets Pflanztopfuntersetzer oder Töpfe mit angepasster Größe für Behälter und Pflanze. Reinigen Sie regelmäßig Öffnung und Rohr der Drainage. Sie riskieren, dass Öffnung und Rohr der Drainage verstopfen und somit die Funktion und Sicherheit nicht gewährleistet ist. Reinigen Sie regelmäßig Öffnung und Rohr der Drainage.

A-malo luce outdoor

Superficie opaca
Matt finished
Surface opaque
Matt-Oberfläche



codice senza colore code without colour	Cm	dimensioni dimensions	Confezione minima Minimum package
13 452 150 anello luce	043 037 150	a 150	1 150x150x8h 0,18
13 452 220 anello luce	043 037 220	a 220	1 158x158x120h 2,99

Luce inclusa White cold lamp Ampoule à blanche Lampe weiss



Per tutti gli articoli della linea Luce è possibile acquistare come supplemento la lampadina LED, disponibile in due versioni:

For all items of the collection Luce it is possible to buy an additional LED lamp, of which two options are available:

Pour tous les articles de la ligne Luce il est possible d'acheter à part l'ampoule led disponible en deux versions:

Für alle Artikel der Linie Luce besteht die Möglichkeit die LED Lampen in zwei Versionen zu erwerben:

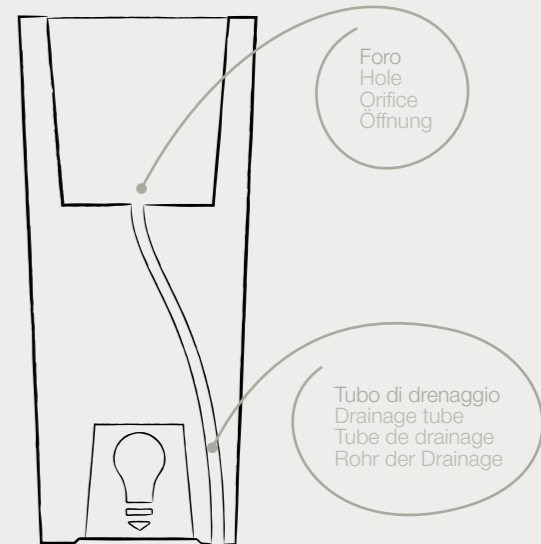

Luce led bianca optional Additional led lamp Ampoule à leds supplémentaire Zusatz led Lampe



codice senza colore code without colour	Confezione minima Minimum package
10 906 000	1



Luce led multicolor con telecomando optional
Multicoloured led lamp with remote control
Ampoule à leds à couleurs changeantes avec télécommande
Lampe led multicolor mit Fernbedienung

codice senza colore code without colour	Confezione minima Minimum package
10 907 000	1

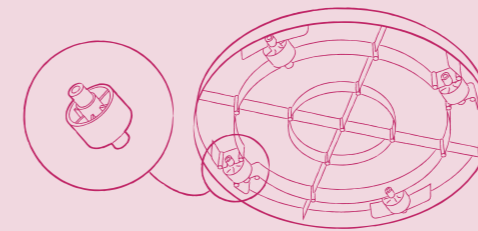

Mover è dotato di ruote bidirezionali ad incastro.

Mover has got bidirectional wheels.

Le Mover a les roues bidirectionnels.

Der Mover hat bidirektionale Räder.

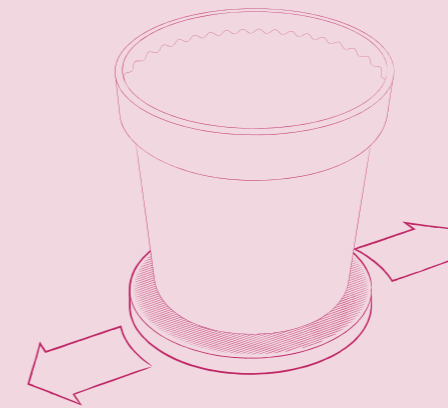

005
antracite/anthracite
anthracite/anthrazitgrau

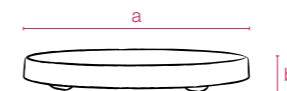

codice senza colore code without colour	Cm	dimensioni dimensions	Confezione minima Minimum package	m ³	pezzi pallet pcs pallet	m ³
10 121 029	29	a29 b2,6	30 58X29X41h	0,07	240 80x120x100h	1,15
10 121 034	34	a34 b2,6	15 34X34X41h	0,05	180 80x120x100h	1,15
10 121 039	39	a39 b2,6	14 39X39X41h	0,06	180 80x120x100h	1,15



Superficie opaca
Matt finished
Surface opaque
Matt-Oberfläche



Mover

Fix Ground round



ACCESSORI: articoli molto semplici ma di sicuro utilizzo. Fissati a una parete o sul pavimento riducono notevolmente le possibilità di ribaltamento accidentale.

ACCESSORIES: items very simple but certainly used. Attached to a wall or lying on the floor they reduced significantly the possibility of rollover accident.

ACCESSOIRES: des articles très simples mais sûrement utiles. Fixés au mur ou au plancher, ils réduisent considérablement le risque de renversement accidentel.

ZUBEHÖR: diese Artikel sind sehr einfach aber ganz sicherlich nützlich. Festgeschraubt auf einer Wand oder auf dem Boden, reduzieren sie stark das Umkippenrisiko.

codice senza colore code without colour	Cm	dimensioni dimensions	Confezione minima Minimum package	m ³
10 903 041	41	a41 b0,5	2 42x42x4h	0,01
10 903 048	48	a48 b0,5	2 50x50x4h	0,01
10 903 060	60	a60 b0,5	2 62x62x4h	0,01

Fix Ground square

codice senza colore code without colour	Cm	dimensioni dimensions	Confezione minima Minimum package	m ³
10 908 039	39	a39 b0,5	2 40x40x4h	0,01

Fix Wall

codice senza colore code without colour	Cm	dimensioni dimensions	Confezione minima Minimum package	m ³
10 904 007	7	a21 b0,5	2 25x15x5h	0,002

Il lucchetto non è incluso
Padlock not included
Cadenas non inclus
Vorhängeschloss nicht inklusive



Progetto grafico ed impaginazione:

Verde Pistacchio - info@verdepistacchio.net

Le ambientazioni:

Alexis visual arts - Via Giovanni Dolfin, 8 - 36016 Thiene (VI) - www.alexisvisual.com per pag. 41.

Verde Architettura - via Fumagalli, 7 - 20143 (MI) - www.verdearchitettura.it per pag. 218.

Anymotion - Corso Garibaldi, 81 - 29017 Fiorenzuola D'Arda (PC) pag. 214, 215, 216, 219.

Foto:

Photopiù - Via Rivarotta, 165 - 36061 Bassano del Grappa (VI) - www.photopiu.it

BitCreativo di Mazzaro Elia - Via Col di Lana, 10 - 36034 Malo (VI) - www.bitcreativo.it

Designer:

favarettoandpartner di pag. 40.

Irina Alekseeva di pag. 206, 207, 208.

Dati, foto e caratteristiche non sono impegnativi; Teraplast si riserva di apportare le modifiche che riterrà opportune per migliorare i suoi prodotti.

Tutte le parti di questo catalogo - foto comprese - sono di proprietà di Teraplast. La riproduzione, anche parziale, è vietata in ogni forma e con ogni mezzo.

Data, photos, and characteristics are not binding; Teraplast reserves the right to produce modifications considered necessary to improve its products.

Every part of this catalogue - photos included - is the property of Teraplast. All forms of copying are strictly prohibited.

TeraPlast™ S.p.a.

Via del Progresso, 65 (GPS: Località Conca)
36070 Castelgomberto (VI) - ITALY
tel. +39 0445 444 100 - fax +39 0445 444 111
www.teraplast.com - info@teraplast.com