



*Gdzie natura nie sięga...*

CENNIK 2020

# H 700

Ilość poziomów	Kubatura (L)	Wysokość całkowita (mm)	Średnica podstawy (mm)	Waga (kg)	Materiał	Cena netto
3	167	720	750	35	STAL CYNKOWANA OGNIOWO	1 150 zł
					STAL NIERDZEWNA	2 250 zł

\* Opcje dodatkowe



Malowanie proszkowe  
205 zł



System nawadniania  
200 zł



System stabilizacyjny  
-



System mobilny  
150 zł



Uszczelka  
6zł/m



Ukwiecenie  
650 zł

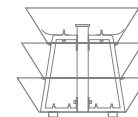

# H 750

Ilość poziomów	Kubatura (L)	Wysokość całkowita (mm)	Średnica podstawy (mm)	Waga (kg)	Materiał	Cena netto
3	373	740	1200	58	STAL CYNKOWANA OGNIOWO	1 750 zł
					STAL NIERDZEWNA	3 375 zł

\* Opcje dodatkowe



Malowanie proszkowe  
240 zł



System nawadniania  
220 zł



System stabilizacyjny  
150 zł



System mobilny  
300 zł



Uszczelka  
6zł/m



Ukwiecenie  
910 zł

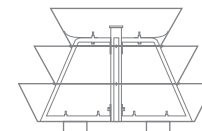

## H 1050

Ilość poziomów	Kubatura (L)	Wysokość całkowita (mm)	Średnica podstawy (mm)	Waga (kg)	Materiał	Cena netto
5	397	1 160	1 050	45	STAL CYNKOWANA OGNIOWO	<b>3 100 zł</b>
					STAL NIERDZEWNA	<b>4 900 zł</b>

\* Opcje dodatkowe



Malowanie proszkowe  
**400 zł**



System nawadniania  
**300 zł**



System stabilizacyjny  
**150 zł**



System mobilny  
**300 zł**



Uszczelka  
**6zł/m**



Ukwiecenie  
**1 490 zł**

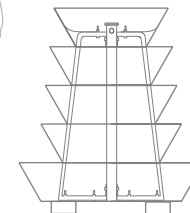

## H 1100

Ilość poziomów	Kubatura (L)	Wysokość całkowita (mm)	Średnica podstawy (mm)	Waga (kg)	Materiał	Cena netto
6	125	1010	600	30	STAL CYNKOWANA OGNIOWO	<b>990 zł</b>
					STAL NIERDZEWNA	<b>1 750 zł</b>

\* Opcje dodatkowe



Malowanie proszkowe  
**w cenie**



System nawadniania  
**250 zł**



System stabilizacyjny  
**-**



System mobilny  
**150 zł**



Uszczelka  
**6zł/m**



Ukwiecenie  
**700 zł**

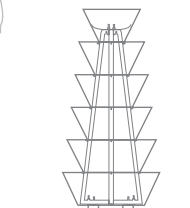

# H 1200

Ilość poziomów	Kubatura (L)	Wysokość całkowita (mm)	Średnica podstawy (mm)	Waga (kg)	Materiał	Cena netto
6	668	1355	1200	86	STAL CYNKOWANA OGNIOWO	3 700 zł
					STAL NIERDZEWNA	5 250 zł

\* Opcje dodatkowe



Malowanie proszkowe  
450 zł



System nawadniania  
300 zł



System stabilizacyjny  
150 zł



System mobilny  
300 zł



Uszczelka  
6zł/m



Ukwiecenie  
1 590 zł

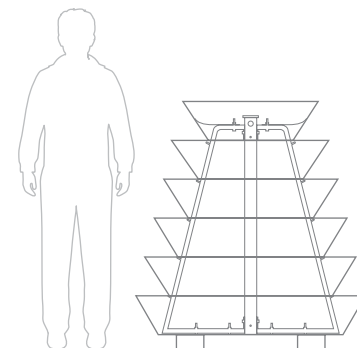

# H 1200<sup>ROUND</sup>

Ilość poziomów	Kubatura (L)	Wysokość całkowita (mm)	Średnica podstawy (mm)	Waga (kg)	Materiał	Cena netto
6	2 x 307	1355	1200	2 x 60	STAL CYNKOWANA OGNIOWO	4 300 zł
					STAL NIERDZEWNA	6 250 zł

\* Opcje dodatkowe



Malowanie proszkowe  
450 zł



System nawadniania  
240 zł



System stabilizacyjny  
-



System mobilny  
-



Uszczelka  
6zł/m



Ukwiecenie  
1 590 zł

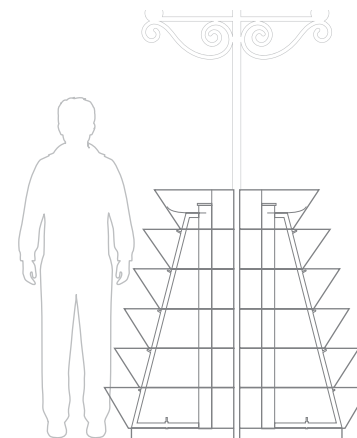

## H 1200 <sup>1/2</sup>

Ilość poziomów	Kubatura (L)	Wysokość całkowita (mm)	Średnica podstawy (mm)	Waga (kg)	Materiał	Cena netto
6	314	1355	½ 1200	60	STAL CYNKOWANA OGNIOWO	2 150 zł
					STAL NIERDZEWNA	3 750 zł

\* Opcje dodatkowe



Malowanie proszkowe  
260 zł



System nawadniania  
240 zł



System stabilizacyjny  
150 zł



System mobilny  
-



Uszczelka  
6zł/m



Ukwiecenie  
875 zł



## H 1200 <sup>1/4</sup>

Ilość poziomów	Kubatura (L)	Wysokość całkowita (mm)	Średnica podstawy (mm)	Waga (kg)	Materiał	Cena netto
6	157	1355	¼ 1200	17	STAL CYNKOWANA OGNIOWO	1 350 zł
					STAL NIERDZEWNA	2 750 zł

\* Opcje dodatkowe



Malowanie proszkowe  
170 zł



System nawadniania  
220 zł



System stabilizacyjny  
150 zł



System mobilny  
-



Uszczelka  
6zł/m



Ukwiecenie  
575 zł

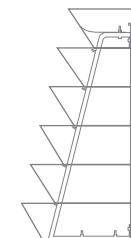

# H 2000

Ilość poziomów	Kubatura (L)	Wysokość całkowita (mm)	Średnica podstawy (mm)	Waga (kg)	Materiał	Cena netto
9	1168	1990	1200	124	STAL CYNKOWANA OGNIOWO	4 550 zł
					STAL NIERDZEWNA	8 250 zł

\* Opcje dodatkowe



Malowanie proszkowe  
645 zł



System nawadniania  
400 zł



System stabilizacyjny  
150 zł



System mobilny  
-



Uszczelka  
6zł/m



Ukwiecenie  
2 490 zł

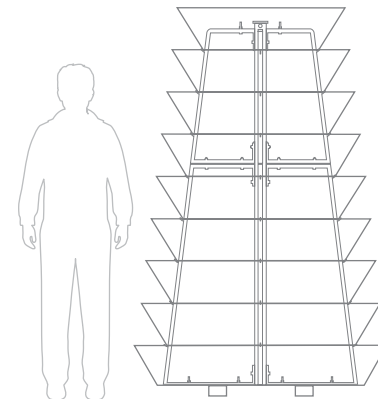

# H 2000 <sup>1/2</sup>

Ilość poziomów	Kubatura (L)	Wysokość całkowita (mm)	Średnica podstawy (mm)	Waga (kg)	Materiał	Cena netto
9	584	1990	½ 1200	62	STAL CYNKOWANA OGNIOWO	3 550 zł
					STAL NIERDZEWNA	5 750 zł

\* Opcje dodatkowe



Malowanie proszkowe  
480 zł



System nawadniania  
320 zł



System stabilizacyjny  
150 zł



System mobilny  
-



Uszczelka  
6zł/m



Ukwiecenie  
1 300 zł

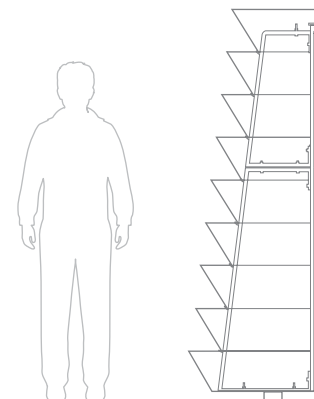

# H 2400

Ilość poziomów	Kubatura (L)	Wysokość całkowita (mm)	Średnica podstawy (mm)	Waga (kg)	Materiał	Cena netto
12	1335	2610	1200	147	STAL CYNKOWANA OGNIOWO	4 950 zł
					STAL NIERDZEWNA	8 500 zł

\* Opcje dodatkowe



Malowanie proszkowe  
720 zł



System nawadniania  
500 zł



System stabilizacyjny  
150 zł



System mobilny  
-



Uszczelka  
6zł/m



Ukwiecenie  
2 950 zł

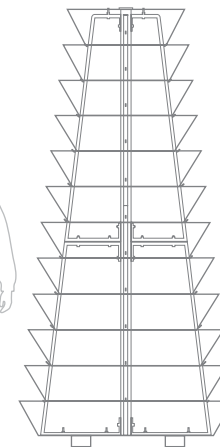

# H 2400 <sup>1/2</sup>

Ilość poziomów	Kubatura (L)	Wysokość całkowita (mm)	Średnica podstawy (mm)	Waga (kg)	Materiał	Cena netto
12	667	2610	½ 1200	103	STAL CYNKOWANA OGNIOWO	3 500 zł
					STAL NIERDZEWNA	6 000 zł

\* Opcje dodatkowe



Malowanie proszkowe  
520 zł



System nawadniania  
400 zł



System stabilizacyjny  
150 zł



System mobilny  
-



Uszczelka  
6zł/m



Ukwiecenie  
1 600 zł

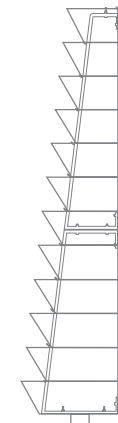

# H 3000

Ilość poziomów	Kubatura (L)	Wysokość całkowita (mm)	Średnica podstawy (mm)	Waga (kg)	Materiał	Cena netto
15	1390	3105	1200	175	STAL CYNKOWANA OGNIOWO	5 350 zł
					STAL NIERDZEWNA	9 750 zł

\* Opcje dodatkowe



Malowanie proszkowe  
800 zł



System nawadniania  
600 zł



System stabilizacyjny  
150 zł



System mobilny  
-



Uszczelka  
6zł/m



Ukwiecenie  
3 350 zł

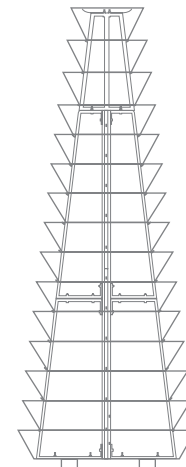

# H 3400

Ilość poziomów	Kubatura (L)	Wysokość całkowita (mm)	Średnica podstawy (mm)	Waga (kg)	Materiał	Cena netto
17	1490	3435	1200	190	STAL CYNKOWANA OGNIOWO	5 750 zł
					STAL NIERDZEWNA	10 250 zł

\* Opcje dodatkowe



Malowanie proszkowe  
860 zł



System nawadniania  
700 zł



System stabilizacyjny  
150 zł



System mobilny  
-



Uszczelka  
6zł/m



Ukwiecenie  
3 650 zł





# W 600/1

Ilość poziomów	Kubatura (L)	Wysokość całkowita (mm)	Średnica górna pierścieni (mm)	Waga (kg)	Materiał	Cena netto
1	46	220	A1-650	2 x 6	STAL CYNKOWANA OGNIOWO	<b>640 zł</b>

\* Opcje dodatkowe



Malowanie proszkowe  
**w cenie**



Sys. nawadniania  
-



Sys. podwójnego dna  
**w cenie**



Mocowanie  
**w cenie**



Uszczelka  
**6zł/m**



Ukwiecenie  
**200 zł**



Wkładka uprawna Culture Tub  
**290 zł** **Nowość**

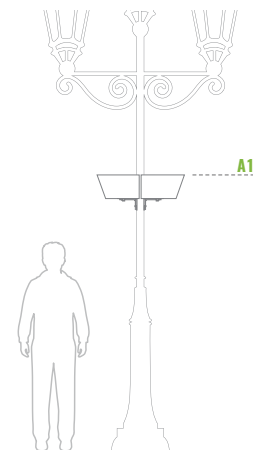

# W 600/2

Ilość poziomów	Kubatura (L)	Wysokość całkowita (mm)	Średnica górna pierścieni (mm)	Waga (kg)	Materiał	Cena netto
2	58	330	A1-600/A2-500	2 x 7	STAL CYNKOWANA OGNIOWO	<b>760 zł</b>

\* Opcje dodatkowe



Malowanie proszkowe  
**w cenie**



System nawadniania  
**150 zł**



System podwójnego dna  
**w cenie**



Mocowanie  
**w cenie**



Uszczelka  
**6zł/m**



Ukwiecenie  
**315 zł**

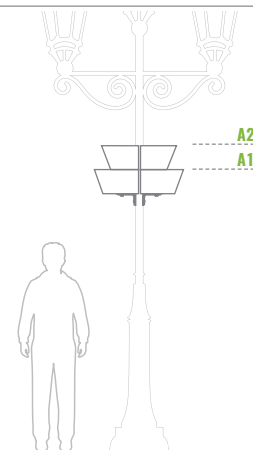

## W 600/3

Ilość poziomów	Kubatura (L)	Wysokość całkowita (mm)	Średnica górna pierścieni (mm)	Waga (kg)	Materiał	Cena netto
3	70	475	A1-600/A2-500/A3-400	2 x 9	STAL CYNKOWANA OGNIOWO	870 zł

\* Opcje dodatkowe



Malowanie proszkowe  
w cenie



System nawadniania  
190 zł



System podwójnego dna  
w cenie



Mocowanie  
w cenie



Uszczelka  
6zł/m



Ukwiecenie  
400 zł

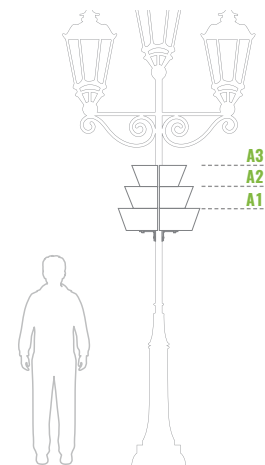

## W 800/1

Ilość poziomów	Kubatura (L)	Wysokość całkowita (mm)	Średnica górna pierścieni (mm)	Waga (kg)	Materiał	Cena netto
1	75	270	B1-800	2 x 11	STAL CYNKOWANA OGNIOWO	960 zł

\* Opcje dodatkowe



Malowanie proszkowe  
w cenie



Sys. nawadniania  
-



Sys. podwójnego dna  
w cenie



Mocowanie  
w cenie



Uszczelka  
6zł/m



Ukwiecenie  
350 zł



Wkładka uprawna Culture Tub  
380 zł

Nowość

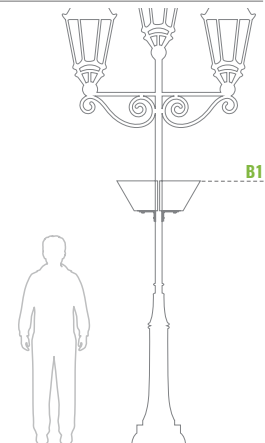

**Terra**<sup>®</sup>  
Group



*TerraKaskady - marka z portfela Terra Group*

**Terra Group**

Razem stworzymy  
piękniejsze jutro!

ul. Gen. Józefa Sowińskiego 42a T: +48 68 455 62 69  
65-419 Zielona Góra F.: +48 68 414 54 25

E: [info@terra-pl.eu](mailto:info@terra-pl.eu)  
[www.terra-pl.eu](http://www.terra-pl.eu)

*[www.wiezekwiatowe.pl](http://www.wiezekwiatowe.pl)*