

2017

MADE IN ITALY

TeraPlast | FITOUT circle
italian beauty

news
2017

LINEELEMENTS

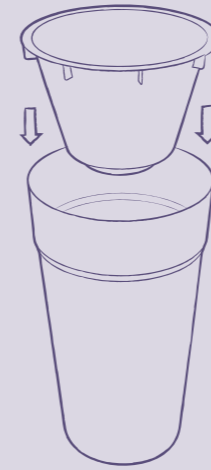

Zbiornik na wodę
Water reserve
Réserve d'eau
Wasser-Reservoir

przepływ wody
poprzez efekt osmozy
water diffusion through
osmosis's effect
diffusion de l'eau par
osmose
Wasserdiffusion durch
Osmose

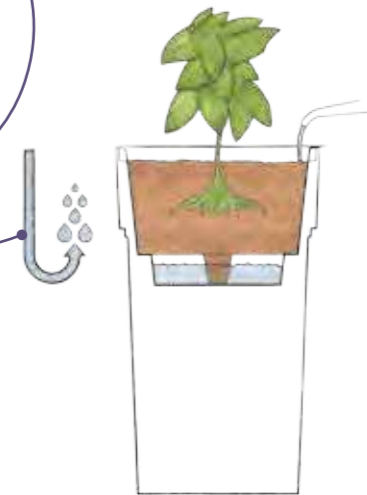

022
biały /white
blanc/weiß



414
szary / fog grey
brouillard gris/Nebel grau



406
brązowy /brown
brun/braun



416
marsala /marsala
marsala /marsala



404
limonka /cedar
cèdre/zeder



005
antracyt /anthracite
anthracite/anthrazitgrau

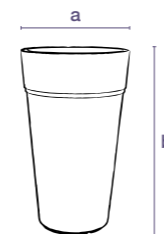

kod bez koloru code without colour	Cm	wymiar dimensions	litry liters	minimum zamówienia + wymiar po zapakowaniu	ilość na paletę	
				Minimum package m³	pcs pallet	m³
28 124 065	65	a38 b65	14	5 40x40x106h 0,17	60	80x120x229h 2,1
28 124 080	80	a38 b80	14	4 40x40x112h 0,18	48	80x120x240h 2,3



Stem

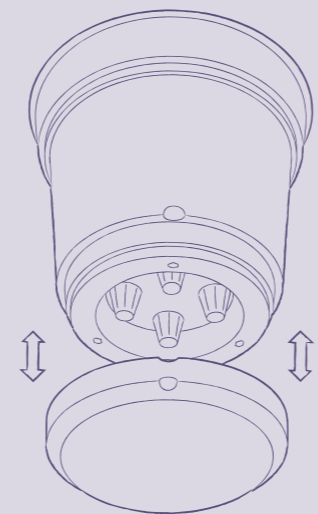

 Pasująca podstawka w zestawie.
The saucer is included and is fitted into.
La soucoupe est inclus et est emboîtée dans.
Der Untersetzer ist eingeschlossen und mit Clip-Funktion zusammengesteckt.

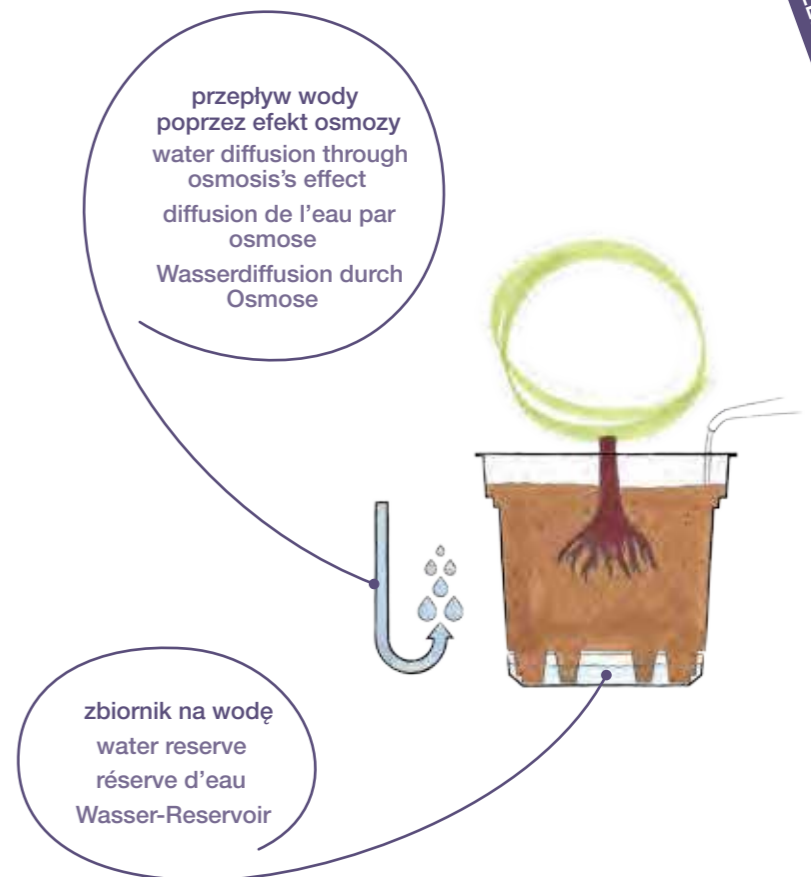

005
antracyt /anthracite
anthracite/anthrazitgrau

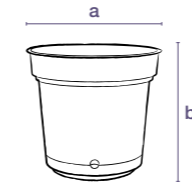

kod bez koloru code without colour	Cm	wymiary dimensions	litry liters	minimum zamówienia + wymiary po zapakowaniu		ilość na palecie		
				Minimum package	m ³	pcs pallet	m ³	
28 107 018	005 18	a18 b16	2,5	20	18x18x33h	0,008	120 57x50x53h	0,15
28 107 023	005 23	a23 b21	5	10	23x23x43h	0,030	540 80x115x115h	1,06
28 107 028	005 28	a28 b25	9,3	10	28x28x48h	0,030	330 80x115x115h	1,06
28 107 033	005 33	a33 b30	15,3	10	33x33x43h	0,037	140 80x120x120h	1,32
28 107 038	005 38	a38 b34	23	8	38x38x68h	0,077	96 80x115x115h	1,06
28 107 048	005 48	a48 b43	46,5	4	48x48x58h	0,105	144 100x115x230h	2,65
28 107 058	005 58	a58 b48	77	4	58x58x68h	0,180	96 100x115x220h	2,12
28 107 068	005 68	a68 b55	120	2	68x68x60h	0,218	26 78x78x230h	1,40
28 107 078	005 78	a78 b61	175,5	2	78x78x65h	0,310	22 78x78x230h	1,40

news
2017



043
biały /white
blanc/weiß



201
cappuccino /cappuccino
cappuccino/cappuccino



235
beton /beton
beton/beton



032
antracyt /anthracite
anthracite/anthrazitgrau



039
brązowy /bronze
bronze/bronze

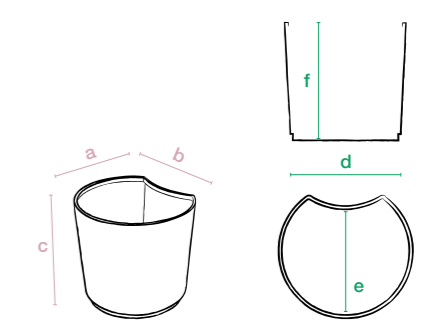

kod bez koloru code without colour	Cm	wymiarzy zewnętrzne external dimensions			wymiarzy wewnętrzne internal dimensions			litry liters	minimum zamówienia + wymiarzy po zapakowaniu		ilość na palecie			
		a	b	c	d	e	f		Minimum package	m ²	pcs pallet	m ²		
29 472 040	40	41	46,6	39,8	44,5	35	38,5	52	2	41x46,6x63h	0,11	44	80x120x230h	2,2
29 472 047	47	46,3	51,5	47,2	49	41	46	77	2	46,3x51,5x67h	0,16	40	100x115x224h	2,5
29 472 054	54	51,4	56,1	54	54	45	53	106	2	51,4x56,1x72,5h	0,2	36	100x115x218h	2,5

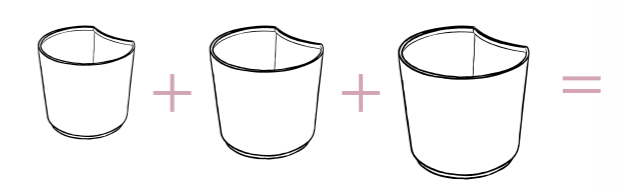

kod bez koloru code without colour	Cm	wymiarzy dimensions			minimum zamówienia + wymiarzy po zapakowaniu		ilość na palecie		
		a	b	c	Minimum package	m ²	pcs pallet	m ²	
14 999 002	40	51,4	56,1	54	1	51,4x56,1x54h	0,15	16	100x120x204h





Arena, Indy, Pixel, Ring i Urban
razem prezentują się świetnie.
Arena, Indy, Pixel, Ring and
Urban have a stunning finish in
common.
Arena, Indy, Pixel, Ring et
Urban ont une superbe finition
en commun.
Arena, Indy, Pixel, Ring und
Urban haben alle eine ganz
besondere Oberfläche



043

biały /white
blanc/weiß



201

cappuccino /cappuccino
cappuccino/cappuccino



235

beton /beton
beton/beton

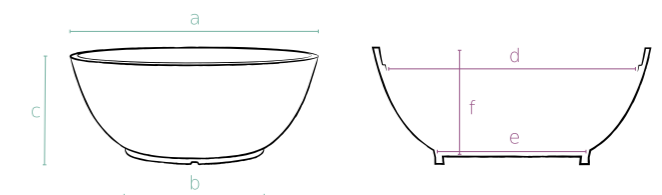

kod bez koloru code without colour	Cm	wymiarzy zewnętrzne external dimensions			wymiarzy wewnętrzne internal dimensions			liters	minimum zamówienia + wymiarzy po zapakowaniu			ilość na palecie		
		a	b	c	d	e	f		Minimum package	pcs	m ²	pcs pallet	m ²	
29476100030	100	a100	b55	c40	d89	e54	f39	210	1	100x55x40h	0, 2	18	100x100x230h	2,3
29476115030	115	a115	b65	c46	d104	e63	f46	320	1	115x65x46h	0,34	16	115x115x230h	3,0
29476130030	130	a130	b73	c52	d118	e71	f50	460	1	130x73x52h	0,49	14	130x130x230h	3,9



Arena

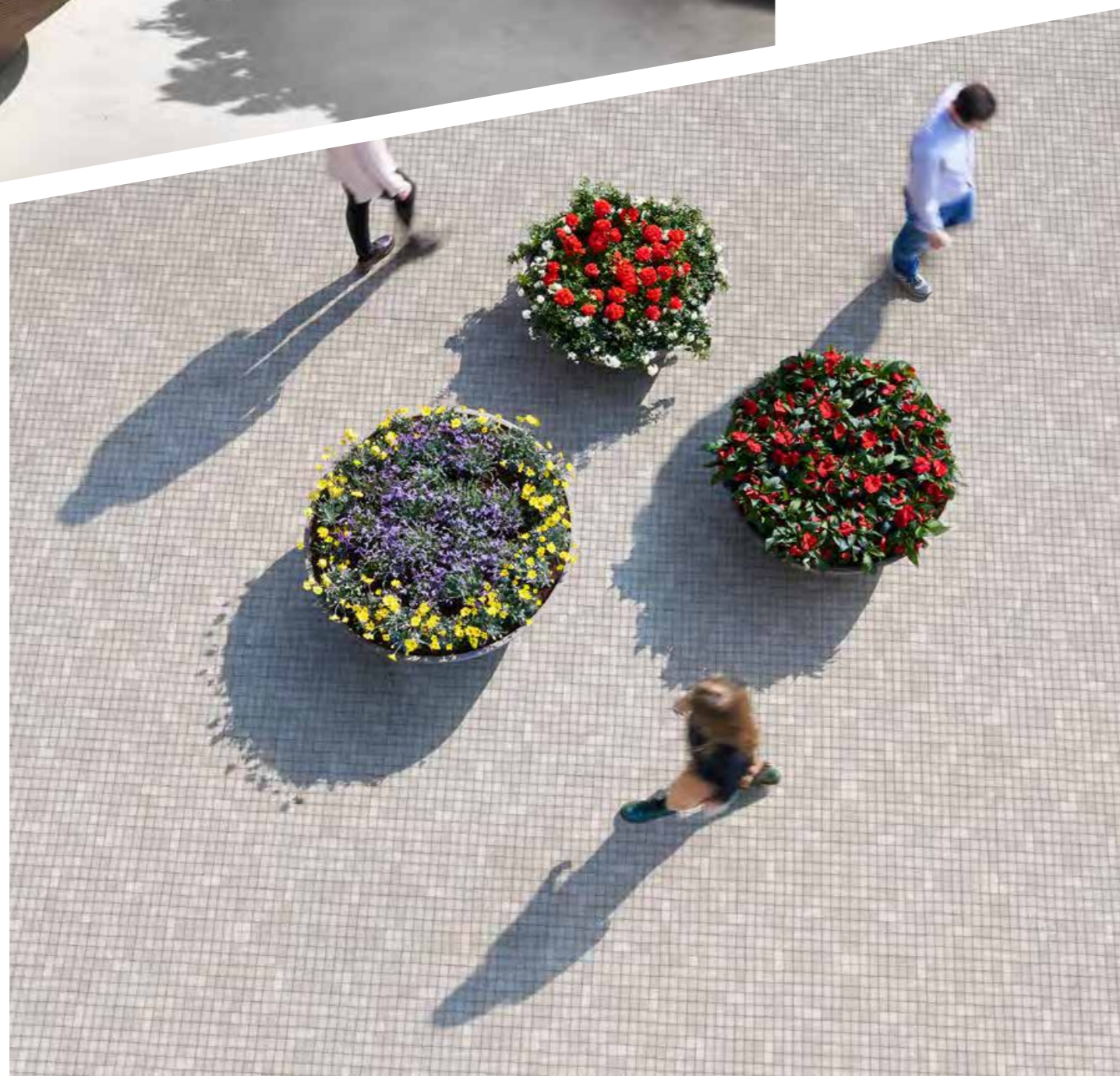

032
antracyt /anthracite
anthracite/anthrazitgrau



039
brązowy /bronz
bronze/bronze



030
jasny brąz /light brown
marron clair/hellbraun

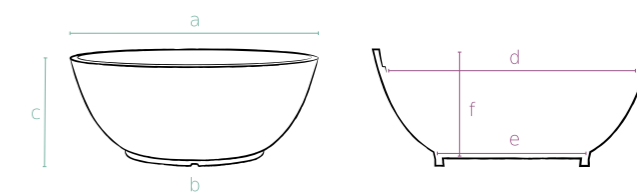

kod bez koloru code without colour	Cm	wymiarzy zewnętrzne external dimensions			wymiarzy wewnętrzne internal dimensions			litry liters	minimum zamówienia + wymiarzy po zapakowaniu			ilość na palecie		
		a	b	c	d	e	f		Minimum package	m ²	pcs pallet	m ²		
29476100030	100	a100	b55	c40	d89	e54	f39	210	1	100x55x40h	0, 2	18	100x100x230h	2,3
29476115030	115	a115	b65	c46	d104	e63	f46	320	1	115x65x46h	0,34	16	115x115x230h	3,0
29476130030	130	a130	b73	c52	d118	e71	f50	460	1	130x73x52h	0,49	14	130x130x230h	3,9

news
2018



043
biały /white
blanc/weiß



201
cappuccino /cappuccino
cappuccino/cappuccino



235
beton /beton
beton/beton



032
antracyt /anthracite
anthracite/anthrazitgrau



039
brązowy /bronze
bronze/bronze

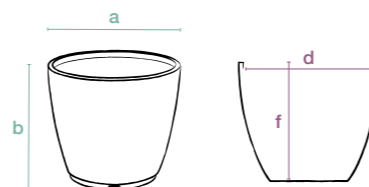

kod bez koloru code without colour	Cm	wymiarzy zewnętrzne external dimensions			wymiarzy wewnętrzne internal dimensions			litry liters	minimum zamówienia + wymiarzy po zapakowaniu Minimum package		ilość na palecie pcs pallet			
		a	b	c	d	e	f		Minimum package	m ³	pcs pallet	m ³		
29 475 038	38	a38	b38	c32	d38	e38	f32	25	2	38x38x51h	0,074	42	80x120x115h	1,104
29 475 048	48	a48	b48	e40,5	d48	e48	f40,5	54	2	48x48x62h	0,143	45	80x120x230h	2,208
29 475 057	57	a57	b57	e48	d57	e57	f48	92	2	58x58x74h	0,249	24	80x120x230h	2,208



Ring



043
biały /white
blanc/weiß



204
jasny szary /silk grey
grise soie/grauer Seide



201
cappuccino /cappuccino
cappuccino/cappuccino



032
antracyt /anthracite
anthracite/anthrazitgrau



039
brązowy /bronze
bronze/bronze



233
toffee /toffee
caramel/Toffee



202
lawędowy /lavender
lavande/lavendel



068
fuksja /fuchsia
fuchsia/fuchsienfarbig



232
kiwi /kiwi
kiwi/Kiwi



Sottovaso

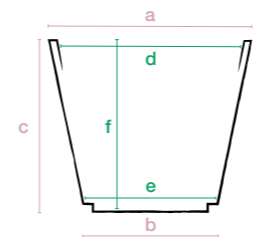

kod bez koloru code without colour	Cm	wymiarzy zewnętrzne external dimensions			wymiarzy wewnętrzne internal dimensions			litry liters	Minimum package	ilość na palecie pcs pallet					
		a	b	e	d	e	f			Minimum package	pcs pallet	m ³			
11 461 035	35	a33	b18,5	e29	d30	e18,5	f28	13	27	2	33x33x37h	0,04	63	80x120x115h	1,10
11 461 040	40	a38	b21,5	e35	d34,5	e21,5	f34	21	30	2	38x38x43h	0,06	114	80x120x230h	2,21
11 461 050	50	a49	b27,5	e43	d44,5	e27,5	f42	44	33	1	49x49x42h	0,10	64	100x120x230h	2,65
11 461 060	60	a57	b32	e49	d52	e32	f49	78	47	1	57x57x49h	0,15	28	80x120x220h	2,11
11 461 080	80	a77	b43	e65	d70	e43	f65	191	54	1	77x77x65h	0,38	10	80x80x220h	1,40

14 **Matowe wykończenie**
Matt finished
Surface opaque
Matt-Oberfläche



Ribeira



043
biały /white
blanc/weiß



204
jasny szary /silk grey
grise soie/grauer Seide



201
cappuccino /cappuccino
cappuccino/cappuccino



068
fukcja /fuchsia
fuchsia/fuch sienfarbig



232
kiwi /kiwi
kiwi/Kiwi



202
lawendowy /lavender
lavande/lavendel



032
antracyt /anthracite
anthracite/anthrazitgrau



Sottovaso

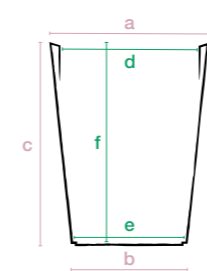

kod bez koloru code without colour	Cm	wymary zewnętrzne external dimensions	wymary wewnętrzne internal dimensions	litry liters	Minimum package	minimum zamówienia + wymary po zapakowaniu		ilość na palecie		
						m ³	pcs pallet	m ³	pcs pallet	m ³
11 465 043	43	a33 b24 c42	d29 e24 f42	24	1	33x24x42h	0,03	96	80x120x225h	2,16
11 465 050	50	a39 b28,5 c50	d35 e28 f49	45	1	39x28,5x50h	0,30	60	80x120x215h	2,06
11 465 065	65	a49 b36 c66	d44 e35 f61	94	1	49x36x66h	0,10	21	80x120x210h	2,02

Schio cono



Matowe wykończenie
Matt finished
Surface opaque
Matt-Oberfläche



tondo Veneto



Matowe wykończenie
Matt finished
Surface opaque
Matt-Oberfläche



039

brązowy /bronze
bronze/bronze



050

czerwony /cardinal red
rouge cardinal/scharlachrot



032

antracyt /anthracite
anthracite/anthrazitgrau



201

cappuccino /cappuccino
cappuccino/cappuccino



043

biały /white
blanc/weiß



043

biały /white
blanc/weiß



201

cappuccino /cappuccino
cappuccino/cappuccino



032

antracyt /anthracite
anthracite/anthrazitgrau



039

brązowy /bronze
bronze/bronze

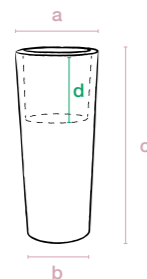

akcesoria
accessories

akcesoria accessories	m³	ilość na palecie		minimum zamówienia + wymiary po zapakowaniu		litry liters	wymiary dimensions		Cm	kod bez koloru code without colour
		pcs	pallet	m³	Minimum package					
	80x120x225h	2,16	24	0,06	30x30x68h	1	a30 b23 c68 d20	8	70	11 424 070
	80x120x195h	1,87	12	0,14	40x40x90h	1	a40 b29,5 c90 d26	26	90	11 424 090
	80x120x236h	2,27	12	0,22	45x45x110h	1	a45 b34,5 c110 d28	35	110	11 424 110
	100x120x160h	1,92	4	0,43	55x55x145h	1	a55 b44,5 c145 d31	46	145	11 424 145

Mocowanie do podłoża
Mocowanie do ściany

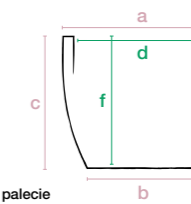

kod bez koloru code without colour	Cm	wymiary zewnętrzne external dimensions		wymiary wewnętrzne internal dimensions		litry liters	minimum zamówienia + wymiary po zapakowaniu		ilość na palecie				
		a	b	c	d		f	Minimum package	m³	pcs pallet	m³		
11 448 032	32	a32	b21	c27	d26	f25	11	2	32x32x48h	0,04	64	80x120x232h	2,23
11 448 042	42	a42	b28	c35	d35	f33	26	2	42x42x63h	0,11	36	80x120x222h	2,13
11 448 052	52	a52	b36	c43	d43	f40	49	2	52x52x80h	0,21	15	80x120x227h	2,72
11 448 062	62	a62	b36	c50	d50	f44	64	2	62x62x88h	0,33	10	80x120x207h	1,99





Matowe wykończenie
Matt finished
Surface opaque
Matt-Oberfläche

Tulipano outdoor

charakterystyka oświetlenia: oprawka e27, max. napięcie 220V, max. moc elektryczna 11W, standardowa żarówka energooszczędna
lamp characteristics: electrical coupling E27, max voltage 220, max electrical power 11 W, standard energy saving type lamp
caractéristiques de l'ampoule: culot E27, tension max 220, puissance max 11W, type économie d'énergie standard
charakteristik der Lampe E27 Fassung, max. 220 Volt max. 11 W. Energiesparlampe Typ Standard

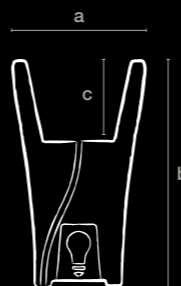

Matowe wykończenie
Matt finished
Surface opaque
Matt-Oberfläche

Schio cono outdoor

charakterystyka oświetlenia: oprawka e27, max. napięcie 220V, max. moc elektryczna 11W, standardowa żarówka energooszczędna
lamp characteristics: electrical coupling E27, max voltage 220, max electrical power 11 W, standard energy saving type lamp
caractéristiques de l'ampoule: culot E27, tension max 220, puissance max 11W, type économie d'énergie standard
charakteristik der Lampe E27 Fassung, max. 220 Volt max. 11 W. Energiesparlampe Typ Standard

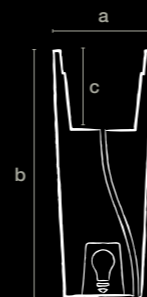

kod bez koloru code without colour	Cm	wymiar dimensions	litry liters	minimum zamówienia + wymiar po zapakowaniu		ilość na palecie		akcesoria accessories
				Minimum package	m ³	pcs pallet	m ³	
13 424 070	033 70	a30 b68 c20	8	1 30x30x68h	0,06	24 80x120x225h	2,10	
13 424 090	033 90	a40 b90 c35	26	1 40x40x90h	0,10	12 80x120x195h	1,80	
13 424 110	033 110	a45 b110 c35	35	1 45x45x110h	0,20	12 80x120x236h	2,20	
13 424 145	033 145	a55 b145 c31	46	1 55x55x145h	0,40	4 100x120x160h	1,90	

Mocowanie do podłoża - ściany



Mocowanie do ściany

akcesoria accessories	m ³	ilość na palecie		m ³	minimum zamówienia + wymiar po zapakowaniu		litry liters	wymiar dimensions		Cm	kod bez koloru code without colour
		pcs pallet	m ³		Minimum package	liters					
	0,76	100x120x230h	6	0,50	1 65x65x110h	a65 b110 c39	65	110	033	13 419 110	



Schio ciotola



Matowe wykończenie
Matt finished
Surface opaque
Matt-Oberfläche



Valentino

Matowe wykończenie / Matt finished
Surface opaque / Matt-Oberfläche

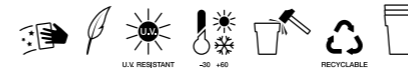

043
biały /white
blanc/weiß



201
cappuccino /cappuccino
cappuccino/cappuccino



032
antracyt /anthracite
anthracite/anthrazitgrau



050
czerwony /cardinal red
rouge cardinal/scharlachrot

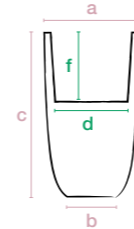

kod bez koloru code without colour	Cm	wymiarzy zewnętrzne external dimensions			wymiarzy wewnętrzne litry internal dimensions liters			minimum zamówienia + wymiarzy po zapakowaniu Minimum package		ilość na palecie pcs pallet		m ³	akcesoria accessories	
		a	b	c	d	e	f	Minimum package	m ³	pcs pallet	m ³			
11 432 050	50	a34	b21	c50	d26	e22	10	2	34x68x50h	0,11	16	80x120x112h	1,08	
11 432 070	70	a42	b25	c70	d32	e28	17	1	42x42x70h	0,12	18	80x120x226h	2,17	
11 432 090	90	a52	b30	c90	d40	e28	29	1	52x52x90h	0,24	8	100x120x195h	2,34	

Mocowanie do podłoża - ściany

Bassano

Matowe wykończenie / Matt finished
Surface opaque / Matt-Oberfläche

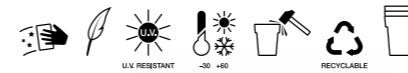

043
biały /white
blanc/weiß



201
cappuccino /cappuccino
cappuccino/cappuccino



032
antracyt /anthracite
anthracite/anthrazitgrau



050
czerwony /cardinal red
rouge cardinal/scharlachrot

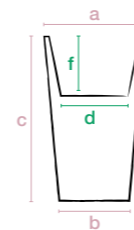

kod bez koloru code without colour	Cm	wymiarzy zewnętrzne external dimensions			wymiarzy wewnętrzne litry internal dimensions liters			minimum zamówienia + wymiarzy po zapakowaniu Minimum package		ilość na palecie pcs pallet		m ³	akcesoria accessories
		a	b	c	d	e	f	Minimum package	m ³	pcs pallet	m ³		
11 423 060	60	a36	b29	c60	d27	e20	1	45x45x60h	0,12	24	80x120x202h	1,94	
11 423 100	100	a48	b35	c100	d35	e34	1	60x60x100h	0,36	6	100x120x165h	1,58	

Mocowanie do podłoża - ściany



043
biały /white
blanc/weiß



201
cappuccino /cappuccino
cappuccino/cappuccino



032
antracyt /anthracite
anthracite/anthrazitgrau



050
czerwony /cardinal red
rouge cardinal/scharlachrot



039
brązowy /bronze
bronze/bronze



030
jasny brązowy /light brown
marron clair/hellbraun

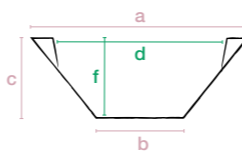

kod bez koloru code without colour	Cm	wymiarzy zewnętrzne external dimensions			wymiarzy wewnętrzne litry internal dimensions liters			minimum zamówienia + wymiarzy po zapakowaniu Minimum package		ilość na palecie pcs pallet		m ³	
		a	b	c	d	e	f	Minimum package	m ³	pcs pallet	m ³		
11 433 060	60	a60	b24,5	c22	d48	e21	22	2	60x60x30h	0,10	26	80x120x113h	1,08
11 433 080	80	a80	b32,5	c29	d64,5	e28	54	2	80x80x39h	0,25	10	80x80x113h	0,72
11 433 100	100	a100	b40	c37	d80	e36	106	1	100x100x37h	0,37	7	100x120x113h	1,36

MADE IN ITALY

TeraPlast
italian beauty

Terra Group
Wrocławska 17B
65-427 Zielona Góra
PL 928 000 48 01

T. +48 68 455 62 69
F. +48 68 359 41 52
info@terra-pl.eu
www.terra-pl.eu

WYŁĄCZNY DYSTRYBUTOR TERAPLAST NA POLSKĘ