



## PEAK (H50 - Ø70) design Aksu, Suardi



Tavolo basso

Anno di produzione: 2013

Versioni: luminosa, laccata.

Materiali: Polietilene, vetro temperato.

Dimensioni: Ø 70 h 50 cm

Peso: 10 Kg

Imballaggio: 71 x 71 x 52 cm

Volume imballaggio: 0,262 m<sup>3</sup>

Table basse

Année de production: 2013

Versions: lumineuse, laquée.

Matériaux: Polyéthylène, verre trempé.

Dimensions: Ø 70 h 50 cm

Poids: 10 Kg

Emballage: 71 x 71 x 52 cm

Volume emballage: 0,262 m<sup>3</sup>

Coffee table

Year of production: 2013

Versions: lighting, lacquered.

Material: Polyethylene, tempered glass.

Dimensions: Ø 70 h 50 cm

Weight: 10 Kg

Packaging: 71 x 71 x 52 cm

Packaging volume: 0,262 m<sup>3</sup>

<b>DIMENSIONS (cm)</b>		
<b>CODE</b>	LP PEA050	
<b>LIGHTING</b>	1x	Energy saving bulb recommended (not included).
<b>COLOURS</b>	<b>LIGHTING COLOURS</b> ○ LIGHT WHITE (code LA)	<b>LACQUERED COLOURS</b> ● SIGNAL WHITE (code QA) ● JET BLACK (code QH) ● IRON GREY (code QG) ● FLAME RED (code QD) ● PURE ORANGE (code QC) ● ZINC YELLOW (code QB) ● LIME GREEN (code QR) ● MAGENTA (code QS) ● METALLIC SILVER (code QM) ● METALLIC GOLD (code QO)



## PEAK (H50 - Ø80) design Aksu, Suardi



Tavolo basso

Anno di produzione: 2013

Versioni: luminosa, laccata.

Materiali: Polietilene, vetro temperato.

Dimensioni: Ø 80 h 50 cm

Peso: 13 Kg

Imballaggio: 81 x 81 x 52 cm

Volume imballaggio: 0,341 m<sup>3</sup>

Table basse

Année de production: 2013

Versions: lumineuse, laquée.

Matériaux: Polyéthylène, verre trempé.

Dimensions: Ø 80 h 50 cm

Poids: 13 Kg

Emballage: 81 x 81 x 52 cm

Volume emballage: 0,341 m<sup>3</sup>

Coffee table

Year of production: 2013

Versions: lighting, lacquered.

Material: Polyethylene, tempered glass.

Dimensions: Ø 80 h 50 cm

Weight: 13 Kg

Packaging: 81 x 81 x 52 cm

Packaging volume: 0,341 m<sup>3</sup>

<b>DIMENSIONS (cm)</b>			
<b>CODE</b>	LP PEA051		
<b>LIGHTING</b>	1x		1x  Energy saving bulb recommended (not included).
<b>COLOURS</b>	<b>LIGHTING COLOURS</b> ○ LIGHT WHITE (code LA)	<b>LACQUERED COLOURS</b> ○ SIGNAL WHITE (code QA) ● JET BLACK (code QH) ● IRON GREY (code QG) ● FLAME RED (code QD) ● PURE ORANGE (code QC) ● ZINC YELLOW (code QB) ● LIME GREEN (code QR) ● MAGENTA (code QS) ● METALLIC SILVER (code QM) ● METALLIC GOLD (code QO)	



## PEAK (H80 - Ø70) design Aksu, Suardi



Tavolo

Anno di produzione: 2010

Versioni: luminosa, laccata.

Materiali: Polietilene, vetro temperato.

Dimensioni: Ø 70 h 80 cm

Peso: 12 Kg

Imballaggio: 71 x 71 x 85 cm

Volume imballaggio: 0,556 m<sup>3</sup>

Table

Année de production: 2010

Versions: lumineuse, laquée.

Matériaux: Polyéthylène, verre trempé.

Dimensions: Ø 70 h 80 cm

Poids: 12 Kg

Emballage: 71 x 71 x 85 cm

Volume emballage: 0,556 m<sup>3</sup>

Table

Year of production: 2010

Versions: lighting, lacquered.

Material: Polyethylene, tempered glass.

Dimensions: Ø 70 h 80 cm

Weight: 12 Kg

Packaging: 71 x 71 x 85 cm

Packaging volume: 0,556 m<sup>3</sup>

DIMENSIONS (cm)		
CODE	LP PEA080	
LIGHTING	1x	1x  Energy saving bulb recommended (not included).
COLOURS	<b>LIGHTING COLOURS</b> ○ LIGHT WHITE (code LA)	<b>LACQUERED COLOURS</b> ● SIGNAL WHITE (code QA) ● JET BLACK (code QH) ● IRON GREY (code QG) ● FLAME RED (code QD) ● PURE ORANGE (code QC) ● ZINC YELLOW (code QB) ● LIME GREEN (code QR) ● MAGENTA (code QS) ● METALLIC SILVER (code QM) ● METALLIC GOLD (code QO)



## PEAK (H80 - Ø80) design Aksu, Suardi



Tavolo

Anno di produzione: 2010

Versioni: luminosa, laccata.

Materiali: Polietilene, vetro temperato.

Dimensioni: Ø 80 h 80 cm

Peso: 15 Kg

Imballaggio: 81 x 81 x 85 cm

Volume imballaggio: 0,558 m<sup>3</sup>

Table

Année de production: 2010

Versions: lumineuse, laquée.

Matériaux: Polyéthylène, verre trempé.

Dimensions: Ø 80 h 80 cm

Poids: 15 Kg

Emballage: 81 x 81 x 85 cm

Volume emballage: 0,558 m<sup>3</sup>

Table

Year of production: 2010

Versions: lighting, lacquered.

Material: Polyethylene, tempered glass.

Dimensions: Ø 80 h 80 cm

Weight: 15 Kg

Packaging: 81 x 81 x 85 cm

Packaging volume: 0,558 m<sup>3</sup>

DIMENSIONS (cm)		
CODE	LP PEA081	
LIGHTING	1x	1x  Energy saving bulb recommended (not included).
COLOURS	<b>LIGHTING COLOURS</b> ○ LIGHT WHITE (code LA)	<b>LACQUERED COLOURS</b> ● SIGNAL WHITE (code QA) ● JET BLACK (code QH) ● IRON GREY (code QG) ● FLAME RED (code QD) ● PURE ORANGE (code QC) ● ZINC YELLOW (code QB) ● LIME GREEN (code QR) ● MAGENTA (code QS) ● METALLIC SILVER (code QM) ● METALLIC GOLD (code QO)



## PEAK (H120 - Ø70) design Aksu, Suardi



Tavolo alto  
 Anno di produzione: 2010  
 Versioni: luminosa, laccata.  
 Materiali: Polietilene, vetro temperato.  
 Dimensioni: Ø 70 h 120 cm  
 Peso: 15 Kg  
 Imballaggio: 71 x 71 x 125 cm  
 Volume imballaggio: 0,63 m<sup>3</sup>

Table haute  
 Année de production: 2010  
 Versions: lumineuse, laquée.  
 Matériaux: Polyéthylène, verre trempé.  
 Dimensions: Ø 70 h 120 cm  
 Poids: 15 Kg  
 Emballage: 71 x 71 x 125 cm  
 Volume emballage: 0,63 m<sup>3</sup>

High table  
 Year of production: 2010  
 Versions: lighting, lacquered.  
 Material: Polyethylene, tempered glass.  
 Dimensions: Ø 70 h 120 cm  
 Weight: 15 Kg  
 Packaging: 71 x 71 x 125 cm  
 Packaging volume: 0,63 m<sup>3</sup>

<b>DIMENSIONS (cm)</b>		
<b>CODE</b>	LP PEA120	
<b>LIGHTING</b>	1x <b>I3 MEDIUM</b>	1x <b>25W</b> Energy saving bulb recommended (not included).
<b>COLOURS</b>	<b>LIGHTING COLOURS</b> ○ LIGHT WHITE (code LA)	<b>LACQUERED COLOURS</b> ○ SIGNAL WHITE (code QA) ● JET BLACK (code QH) ● IRON GREY (code QG) ● FLAME RED (code QD) ● PURE ORANGE (code QC) ● ZINC YELLOW (code QB) ● LIME GREEN (code QR) ● MAGENTA (code QS) ● METALLIC SILVER (code QM) ● METALLIC GOLD (code QO)



## PEAK (H120 - Ø80) design Aksu, Suardi



Tavolo alto  
 Anno di produzione: 2010  
 Versioni: luminosa, laccata.  
 Materiali: Polietilene, vetro temperato.  
 Dimensioni: Ø 80 h 120 cm  
 Peso: 18 Kg  
 Imballaggio: 81 x 81 x 125 cm  
 Volume imballaggio: 0,82 m<sup>3</sup>

Table haute  
 Année de production: 2010  
 Versions: lumineuse, laquée.  
 Matériaux: Polyéthylène, verre trempé.  
 Dimensions: Ø 80 h 120 cm  
 Poids: 18 Kg  
 Emballage: 81 x 81 x 125 cm  
 Volume emballage: 0,82 m<sup>3</sup>

High table  
 Year of production: 2010  
 Versions: lighting, lacquered.  
 Material: Polyethylene, tempered glass.  
 Dimensions: Ø 80 h 120 cm  
 Weight: 18 Kg  
 Packaging: 81 x 81 x 125 cm  
 Packaging volume: 0,82 m<sup>3</sup>

<b>DIMENSIONS (cm)</b>		
<b>CODE</b>	LP PEA121	
<b>LIGHTING</b>	1x	Energy saving bulb recommended (not included).
<b>COLOURS</b>	<b>LIGHTING COLOURS</b> ○ LIGHT WHITE (code LA)	<b>LACQUERED COLOURS</b> ○ SIGNAL WHITE (code QA) ● JET BLACK (code QH) ● IRON GREY (code QG) ● FLAME RED (code QD) ● PURE ORANGE (code QC) ● ZINC YELLOW (code QB) ● LIME GREEN (code QR) ● MAGENTA (code QS) ● METALLIC SILVER (code QM) ● METALLIC GOLD (code QO)



## PEAK (H50 - SQUARE GLASS) design Aksu, Suardi



Tavolo basso  
 Anno di produzione: 2013  
 Versioni: luminosa, laccata.  
 Materiali: Polietilene, vetro temperato.  
 Dimensioni: 80 x 80 h 50 cm  
 Peso: 21 Kg  
 Imballaggio: 81 x 81 x 52 cm  
 Volume imballaggio: 0,341 m<sup>3</sup>

Table basse  
 Année de production: 2013  
 Versions: lumineuse, laquée.  
 Matériaux: Polyéthylène, verre trempé.  
 Dimensions: 80 x 80 h 50 cm  
 Poids: 21 Kg  
 Emballage: 81 x 81 x 52 cm  
 Volume emballage: 0,341 m<sup>3</sup>

Coffee table  
 Year of production: 2013  
 Versions: lighting, lacquered.  
 Material: Polyethylene, tempered glass.  
 Dimensions: 80 x 80 h 50 cm  
 Weight: 21 Kg  
 Packaging: 81 x 81 x 52 cm  
 Packaging volume: 0,341 m<sup>3</sup>

<b>DIMENSIONS (cm)</b>		
<b>CODE</b>	LP PEA052	
<b>LIGHTING</b>	1x	Energy saving bulb recommended (not included).
<b>COLOURS</b>	<b>LIGHTING COLOURS</b> ○ LIGHT WHITE (code LA)	<b>LACQUERED COLOURS</b> ○ SIGNAL WHITE (code QA) ● JET BLACK (code QH) ● IRON GREY (code QG) ● FLAME RED (code QD) ● PURE ORANGE (code QC) ● ZINC YELLOW (code QB) ● LIME GREEN (code QR) ● MAGENTA (code QS) ● METALLIC SILVER (code QM) ● METALLIC GOLD (code QO)



## PEAK (H80 - SQUARE GLASS) design Aksu, Suardi



Tavolo

Anno di produzione: 2012

Versioni: luminosa, laccata.

Materiali: Polietilene, vetro temperato.

Dimensioni: 80 x 80 h 80 cm

Peso: 24 Kg

Imballaggio: 81 x 81 x 85 cm

Volume imballaggio: 0,558 m<sup>3</sup>

Table

Année de production: 2012

Versions: lumineuse, laquée.

Matériaux: Polyéthylène, verre trempé.

Dimensions: 80 x 80 h 80 cm

Poids: 24 Kg

Emballage: 81 x 81 x 85 cm

Volume emballage: 0,558 m<sup>3</sup>

Table

Year of production: 2012

Versions: lighting, lacquered.

Material: Polyethylene, tempered glass.

Dimensions: 80 x 80 h 80 cm

Weight: 24 Kg

Packaging: 81 x 81 x 85 cm

Packaging volume: 0,558 m<sup>3</sup>

DIMENSIONS (cm)				
CODE	LP PEA082			
LIGHTING	1x	Energy saving bulb recommended (not included).		
COLOURS	<table border="0"> <tr> <td style="vertical-align: top;"> <b>LIGHTING COLOURS</b>  <ul style="list-style-type: none"> <li>○ LIGHT WHITE (code LA)</li> </ul> </td> <td style="vertical-align: top;"> <b>LACQUERED COLOURS</b>  <ul style="list-style-type: none"> <li>○ SIGNAL WHITE (code QA)</li> <li>● JET BLACK (code QH)</li> <li>● IRON GREY (code QG)</li> <li>● FLAME RED (code QD)</li> <li>● PURE ORANGE (code QC)</li> <li>● ZINC YELLOW (code QB)</li> <li>● LIME GREEN (code QR)</li> <li>● MAGENTA (code QS)</li> <li>● METALLIC SILVER (code QM)</li> <li>● METALLIC GOLD (code QO)</li> </ul> </td> </tr> </table>		<b>LIGHTING COLOURS</b> <ul style="list-style-type: none"> <li>○ LIGHT WHITE (code LA)</li> </ul>	<b>LACQUERED COLOURS</b> <ul style="list-style-type: none"> <li>○ SIGNAL WHITE (code QA)</li> <li>● JET BLACK (code QH)</li> <li>● IRON GREY (code QG)</li> <li>● FLAME RED (code QD)</li> <li>● PURE ORANGE (code QC)</li> <li>● ZINC YELLOW (code QB)</li> <li>● LIME GREEN (code QR)</li> <li>● MAGENTA (code QS)</li> <li>● METALLIC SILVER (code QM)</li> <li>● METALLIC GOLD (code QO)</li> </ul>
<b>LIGHTING COLOURS</b> <ul style="list-style-type: none"> <li>○ LIGHT WHITE (code LA)</li> </ul>	<b>LACQUERED COLOURS</b> <ul style="list-style-type: none"> <li>○ SIGNAL WHITE (code QA)</li> <li>● JET BLACK (code QH)</li> <li>● IRON GREY (code QG)</li> <li>● FLAME RED (code QD)</li> <li>● PURE ORANGE (code QC)</li> <li>● ZINC YELLOW (code QB)</li> <li>● LIME GREEN (code QR)</li> <li>● MAGENTA (code QS)</li> <li>● METALLIC SILVER (code QM)</li> <li>● METALLIC GOLD (code QO)</li> </ul>			





## PEAK (H120 - SQUARE GLASS 80) design Aksu, Suardi



Tavolo alto  
 Anno di produzione: 2012  
 Versioni: luminosa, laccata.  
 Materiali: Polietilene, vetro temperato.  
 Dimensioni: 80 x 80 h 120 cm  
 Peso: 27 Kg  
 Imballaggio: 81 x 81 x 125 cm  
 Volume imballaggio: 0,82 m<sup>3</sup>

Table haute  
 Année de production: 2012  
 Versions: lumineuse, laquée.  
 Matériaux: Polyéthylène, verre trempé.  
 Dimensions: 80 x 80 h 120 cm  
 Poids: 27 Kg  
 Emballage: 81 x 81 x 125 cm  
 Volume emballage: 0,82 m<sup>3</sup>

High table  
 Year of production: 2012  
 Versions: lighting, lacquered.  
 Material: Polyethylene, tempered glass.  
 Dimensions: 80 x 80 h 120 cm  
 Weight: 27 Kg  
 Packaging: 81 x 81 x 125 cm  
 Packaging volume: 0,82 m<sup>3</sup>

<b>DIMENSIONS (cm)</b>		
<b>CODE</b>	LP PEA122	
<b>LIGHTING</b>	1x	Energy saving bulb recommended (not included).
<b>COLOURS</b>	<b>LIGHTING COLOURS</b> ○ LIGHT WHITE (code LA)	<b>LACQUERED COLOURS</b> ● SIGNAL WHITE (code QA) ● JET BLACK (code QH) ● IRON GREY (code QG) ● FLAME RED (code QD) ● PURE ORANGE (code QC) ● ZINC YELLOW (code QB) ● LIME GREEN (code QR) ● MAGENTA (code QS) ● METALLIC SILVER (code QM) ● METALLIC GOLD (code QO)



## PEAK (H80 - DOUBLE) design Aksu, Suardi



Tavolo

Anno di produzione: 2012

Versioni: luminosa, laccata.

Materiali: Polietilene, vetro temperato.

Dimensioni: 180 x 80 h 80 cm

Peso: 52 Kg

Imballaggio: 181 x 81 x 50 cm

Volume imballaggio: 0,733 m<sup>3</sup>

Table

Année de production: 2012

Versions: lumineuse, laquée.

Matériaux: Polyéthylène, verre trempé.

Dimensions: 180 x 80 h 80 cm

Poids: 52 Kg

Emballage: 181 x 81 x 50 cm

Volume emballage: 0,733 m<sup>3</sup>

Table

Year of production: 2012

Versions: lighting, lacquered.

Material: Polyethylene, tempered glass.

Dimensions: 180 x 80 h 80 cm

Weight: 52 Kg

Packaging: 181 x 81 x 50 cm

Packaging volume: 0,733 m<sup>3</sup>

<b>DIMENSIONS (cm)</b>		
<b>CODE</b>	LP PEA220	
<b>LIGHTING</b>	2x	Energy saving bulb recommended (not included).
<b>COLOURS</b>	<b>LIGHTING COLOURS</b> ○ LIGHT WHITE (code LA)	<b>LACQUERED COLOURS</b> ○ SIGNAL WHITE (code QA) ● JET BLACK (code QH) ● IRON GREY (code QG) ● FLAME RED (code QD) ● PURE ORANGE (code QC) ● ZINC YELLOW (code QB) ● LIME GREEN (code QR) ● MAGENTA (code QS) ● METALLIC SILVER (code QM) ● METALLIC GOLD (code QO)



## PEAK (H120 - DOUBLE) design Aksu, Suardi



Tavolo alto

Anno di produzione: 2012

Versioni: luminosa, laccata.

Materiali: Polietilene, vetro temperato.

Dimensioni: 180 x 80 h 120 cm

Peso: 58 Kg

Imballaggio: 181 x 111 x 50 cm

Volume imballaggio: 1 m<sup>3</sup>

Table haute

Année de production: 2012

Versions: lumineuse, laquée.

Matériaux: Polyéthylène, verre trempé.

Dimensions: 180 x 80 h 120 cm

Poids: 58 Kg

Emballage: 181 x 111 x 50 cm

Volume emballage: 1 m<sup>3</sup>

High table

Year of production: 2012

Versions: lighting, lacquered.

Material: Polyethylene, tempered glass.

Dimensions: 180 x 80 h 120 cm

Weight: 58 Kg

Packaging: 181 x 111 x 50 cm

Packaging volume: 1 m<sup>3</sup>

DIMENSIONS (cm)		
CODE	LP PEA221	
LIGHTING	2x	Energy saving bulb recommended (not included).
COLOURS	<b>LIGHTING COLOURS</b> ○ LIGHT WHITE (code LA)	<b>LACQUERED COLOURS</b> ○ SIGNAL WHITE (code QA) ● JET BLACK (code QH) ● IRON GREY (code QG) ● FLAME RED (code QD) ● PURE ORANGE (code QC) ● ZINC YELLOW (code QB) ● LIME GREEN (code QR) ● MAGENTA (code QS) ● METALLIC SILVER (code QM) ● METALLIC GOLD (code QO)



## PEAK ACCESSORIES



DIMENSIONS (cm) - CODE - COLOURS

### ICE BUCKET

Material: polypropylene (PP).  
Dimensions: Ø 20 h 23 cm

LP BAR116

COLOURS  TRANSPARENT  
 SMOKED GREY

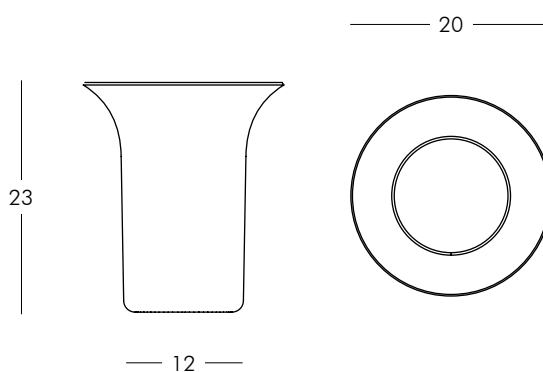

### ASHTRAY

Material: metal.  
Dimensions: Ø 16 h 3,5 cm

SD PEA002

COLOURS  WHITE

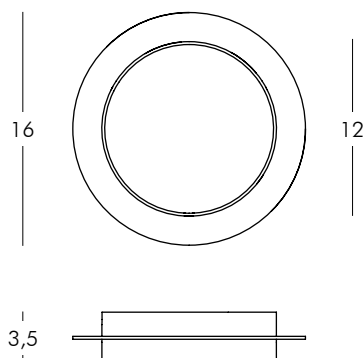
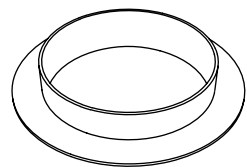

### BAG HOOK







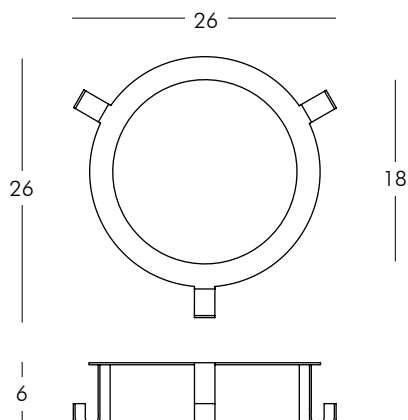
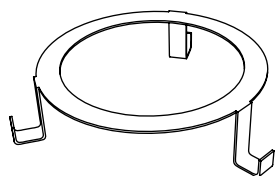







Material: metal.  
Dimensions: 26 x 26 h 6 cm

SD PEA003













COLOURS  WHITE





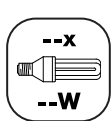

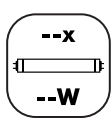
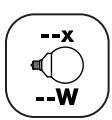





## SYMBOLS

 For indoor use.	 Insulation class 1.	 Protected against the intrusion of solid objects $\varnothing > 12$ mm, not against water.
 For indoor and outdoor use.	 Insulation class 2.	 Protected against the intrusion of solid objects $\varnothing > 1$ mm and splashing water.
 Stackable item.	 Insulation class 3.	 Protected against the intrusion of dust and water jets.
 Conformity to the European Community instructions.	 Device proper to direct assembly onto normally inflammable surfaces.	 Fully protected against the intrusion of dust and immersion in water.
 European Community registered model.	 100% recyclable polyethylene.	 Recycling and disposal of electronic waste (WEEE).

## LIGHTING SYMBOLS

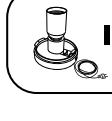
 Small lamp base for E14 - 14 mm light bulb.	 Lamp base for G13 neon tube.	 LED technology lighting system.
 Medium lamp base for E26 - 26 mm light bulb.	 Lamp base for GU10 spotlight.	 Neon tube lighting system.
 Standard lamp base for E27 - 27 mm light bulb.	 Lamp base for G4 halogen bulb.	
 Lighting through energy saving bulb. The upper figure shows the number of allowed bulbs. The lower figure shows the MAXIMUM recommended power.	 Lighting through energy saving fluorescent spotlight. The upper figure shows the number of allowed spotlights. The lower figure shows the MAXIMUM recommended power.	
 Lighting through neon tube. The upper figure shows the number of allowed neon tubes. The lower figure shows the MAXIMUM recommended power.	 Lighting through energy saving globe bulb. The upper figure shows the number of allowed bulbs. The lower figure shows the MAXIMUM recommended power.	
 Lighting through flexible LED tube. The lower figure shows the MAXIMUM recommended power.	 Lighting through circular T9 neon tube. The upper figure shows the number of allowed neon tubes. The lower figure shows the MAXIMUM recommended power.	

## WIRING SYMBOLS

 Wiring with metal clamp. IP20 protection. Diameter 11 cm.	 Wiring with special base for KIT LED 1,5 WATT. IP55 protection. Diameter 11,6 cm.
 Wiring with metal base. IP55 protection. Diameter 10 cm. Fastening by hex screw key.	 Wiring with plastic screw base. I3 - IP20 protection. E3 - IP55 protection. Diameter 6 cm.
 Wiring with metal base. IP55 protection. Diameter 20 cm. Fastening by hex screw key.	 Wiring with plastic screw base. I3 - IP20 protection. E3 - IP55 protection. Diameter 10 cm.
 Wiring with plastic base and metal inserts. I2 - IP20 protection. E2 - IP55 protection. Diameter 10 cm. Fastening by slot screwdriver.	 Wiring with plastic screw base. I3 - IP20 protection. E3 - IP55 protection. Diameter 15 cm.
 Wiring with plastic base for LED LP RGB100. IP44 protection. Diameter 10 cm.	 Special metal base. IP20 protection. Several sizes.

## MATERIAL PROPERTIES

---

Material: Linear low-density polyethylene - LLDPE.

Production process: rotational moulding.

Resistant to extreme temperatures (-60°C to +80°C).

UV resistant (except for lighting colours).

High tensile strength.

## WARNING

---

- Keep away from excessive heat sources.
- Avoid any improper use. Do not stand on the products. When the product has to be moved, lift the product off the ground in order to avoid damage.
- Do not overload the pot structure in order to avoid deforming.
- Carefully comply with the maintenance & cleaning instructions.
- In case of malfunctioning or damage of the wiring or any electrical parts, refer to a qualified electrician.

## MAINTENANCE & CLEANING

---

- To prevent dust and dirt from sticking to the plastic surfaces, periodically clean the products with a damp cloth and neutral liquid soap diluted in water.
- Avoid using ethanol or any liquids containing, even in small amounts, acetone, trichloroethylene or ammonia (solvents in general).
- It is recommended the use of SLIDE's "CleanUp" cleaner or a degreaser. Spray the cleaning product on the surface, rub with a damp cloth and rinse abundantly with water (preferably with a high pressure washer). In case of persistent stains use a high pressure washer or scrub eraser. The use of the scrub eraser (melamine foam - Scotch-Brite® Easy Eraser or similar) is only recommended for white colour, as they are slightly abrasive.
- The lacquered version is also suitable for outdoor use, however it is more sensitive to scratches: periodically clean with a polish cleaner, gently rubbing with soft cloth/cotton wool.
- Cushions can be cleaned with a damp cloth, neutral liquid soap and water.
- For metal parts use specific cleaners.

## SUSTAINABILITY & RECYCLING

---

All SLIDE products are 100% recyclable. Furthermore, grey, black and chocolate matt colours are produced with recycled polyethylene. SLIDE has a closed production cycle with no health prejudicial emissions and complying with ecological sustainability rules.

When a product reaches the end of its life, do not treat the product or any of its parts as domestic waste. Dispose by sending to differentiated collection centres.

## RESPONSIBILITY & RETURNS

---

SLIDE declines any liability to damages caused to things or persons by an illegitimate use of the product. SLIDE won't accept any returned goods without having checked the kind of defects first.

## WARRANTY

---

SLIDE products are guaranteed against all manufacturing faults, granted that the items are appropriately used, for twenty-four (24) months from the date of purchase upon presentation of the invoice.

LED KITS only are guaranteed for twelve (12) months from the date of purchase.

Warranty doesn't include parts that are subject to wear and tear due to usage, batteries when provided, wiring and electrical parts that do not have manufacturing faults.